

ICANN | GNSO

Generic Names Supporting Organization

Phase 1 Final Report on the Internationalized Domain Names Expedited Policy Development Process

09 November 2023

Status of This Document

This is the Phase 1 Final Report of the GNSO Expedited Policy Development Process on Internationalized Domain Names (EPDP-IDNs), covering topics related to top-level gTLD definition and variant management. This Final Report has been submitted to the GNSO Council for its consideration.

Preamble

The objective of this Final Report is to document the EPDP Team's deliberations on Phase 1 charter questions and its sixty-nine (69) final recommendations. This Final Report also documents the Public Comments received on its Phase 1 Initial Report and the EPDP Team's subsequent analysis, as well as other pertinent information that provides background, context, and rationale for its final recommendations.

Table of Contents

1 EXECUTIVE SUMMARY	3
2 EPDP TEAM APPROACH	7
3 GLOSSARY	13
4 PHASE 1 FINAL RECOMMENDATIONS	26
4.1 RZ-LGR AS THE SOLE SOURCE	29
4.2 SAME ENTITY PRINCIPLE	31
4.3 APPLICATION SUBMISSION, ADMINISTRATIVE CHECK, INITIAL EVALUATION	33
4.4 STRING SIMILARITY REVIEW	58
4.5 OBJECTION PROCESSES	73
4.6 STRING CONTENTION	78
4.7 CONTRACTUAL REQUIREMENTS	80
4.8 DELEGATION AND REMOVAL	91
4.9 VARIANT LABEL STATES	102
4.10 CHARTER QUESTIONS WITH NO RECOMMENDATIONS	107
5 DIFFERENCES BETWEEN EPDP-IDNS AND CCPDP4 RECOMMENDATIONS	112
6 NEXT STEPS	119
7 ANNEX A – STRING SIMILARITY REVIEW HYBRID MODEL DELIBERATION	120
8 ANNEX B – EPDP TEAM CHARTER	129
9 ANNEX C – CONSENSUS DESIGNATIONS	163
10 ANNEX D – RESPONSES TO PHASE 1 CHARTER QUESTIONS	167
11 ANNEX E – BACKGROUND	191
12 ANNEX F – EPDP TEAM MEMBERSHIP AND ATTENDANCE	196
13 ANNEX G – COMMUNITY INPUT	201
14 ANNEX H – NEW GTLD PROGRAM PROCESS FLOW DIAGRAM	203

1 Executive Summary

1.1 Introduction

On 20 May 2021, the GNSO Council voted to initiate an Expedited Policy Development Process on Internationalized Domain Names (EPDP-IDNs).¹ The EPDP Team is expected to:

- Determine the approach for a consistent definition of all gTLDs; and
- Develop policy recommendations that will eventually allow for the introduction of variant gTLDs at the top-level.

In accordance with charter requirements and ICANN Board requests, the EPDP Team conducted its deliberations by building on the existing body of policy work, research, and analysis on the IDN subject, including but not limited to:

- IDN-related Outputs under Topic 25 in the GNSO New gTLD Subsequent Procedures (SubPro) PDP Final Report;²
- IDN Variant TLD Management paper developed by ICANN org (“Staff Paper”);³
- Recommendations for the Technical Utilization of the Root Zone Label Generation Rules (RZ-LGR);⁴
- Security and Stability Advisory Committee Advice relevant to IDNs (e.g., SAC052, SAC060).⁵

Since the IDN related SubPro PDP Outputs were developed by considering previous work on IDNs and were already adopted by the ICANN Board, the work of the EPDP Team focused on filling the following gaps not addressed by SubPro PDP:

- Apply SubPro PDP Outputs to existing gTLDs and second-level variant domains;
- Operationalize SubPro PDP Outputs for gTLD variant labels through the New gTLD Program; and
- Deliberate on topics not discussed by SubPro PDP but identified in other previous work on IDNs.

¹ See the approved GNSO Council motion initiating the EPDP here:

<https://gns0.icann.org/en/council/resolutions/2020-current#202105>

² Topic 25 of the SubPro PDP Final Report is focused on IDNs: <https://gns0.icann.org/sites/default/files/file/field-file-attach/final-report-newgtld-subsequent-procedures-pdp-02feb21-en.pdf>. The SubPro PDP Final Report was published in February 2021. A substantial portion of the Outputs was adopted by the ICANN Board in March 2023. See Annex E: Background for additional details.

³ <https://www.icann.org/resources/pages/idn-variant-tld-implementation-2018-07-26-en>

⁴ <https://www.icann.org/en/system/files/files/rz-lgr-technical-utilization-recs-07oct19-en.pdf>

⁵ SAC052: <https://www.icann.org/en/system/files/files/sac-052-en.pdf>; SAC060: <https://www.icann.org/en/system/files/files/sac-060-en.pdf>

When the EPDP Team charter was drafted, there was an expectation that the SubPro Implementation Review Team (IRT) and the EPDP Team would coordinate on addressing overlapping issues. However, coordination was not possible because the SubPro IRT did not start its work until May 2023, and the EPDP Team had to make assumptions about the implementation of the SubPro PDP Outputs in order to address charter questions under overlapping topics.⁶ The ICANN Board's subsequent adoption of the SubPro Outputs related to IDNs means that EPDP Teams assumptions have generally been sound.

In order to support the implementation planning of the SubPro PDP Outputs to facilitate the launch of the next application round of the New gTLD Program, the EPDP Team bifurcated its work into two phases:

- Phase 1 covers topics related to top-level gTLD definition and variant management and is the subject of this Final Report.
- Phase 2 covers issues pertaining to second-level variant management and is expected to be completed by the EPDP Team in 2024.⁷

The EPDP Team has maintained communication with the ccPDP4, which is an ongoing Policy Development Process of the Country Code Names Supporting Organization (ccNSO) focused on IDN ccTLDs. The goal of this communication is to meet the ICANN Board's request that the GNSO and the ccNSO keep each other informed of their respective progress in developing relevant policies and procedures to ensure a consistent solution for variant gTLDs and variant ccTLDs. Section 5 of this Phase 1 Final Report identifies recommendations under five topics covered by both EPDP-IDNs and ccPDP4 where differences exist.

1.2 Final Recommendations

In Phase 1 of the EPDP-IDNs, the EPDP Team was tasked to provide the GNSO Council with recommendations on the top-level gTLD definition and variant management. The EPDP Team identified questions under the following topics in its charter to be addressed in Phase 1:

- Topic A: Consistent definition and technical utilization of RZ-LGR
- Topic B: "Same entity" at the top-level

⁶ On 16 March 2023, the ICANN Board adopted a substantial portion of the New gTLD Subsequent Procedures (SubPro) PDP Outputs and officially kicked off implementation efforts to prepare for launching the next application round of the New gTLD Program. The Outputs adopted by the ICANN Board include all the IDN-related recommendations in Topic 25 of the Final Report. See ICANN Board resolution here:

<https://www.icann.org/en/board-activities-and-meetings/materials/approved-resolutions-regular-meeting-of-the-icann-board-16-03-2023-en>

⁷ See details in the GNSO Council resolution that adopted the Project Change Request from the EPDP Team:

<https://gnso.icann.org/en/council/resolutions/2020-current#202211>; and EPDP Team's updated project plan (November 2022 version):

https://community.icann.org/download/attachments/181306993/EPDP_IDN_Project_Plan_20221107.pdf?version=1&modificationDate=1668662265000&api=v2

- Topic D: Adjustments in registry agreement, registry service, registry transition process, and other processes/procedures related to the domain name lifecycle (partial)
 - Several questions under Topic D are slated for Phase 2
- Topic E: Adjustments to string similarity review, objection process, string contention resolution, reserved strings, and other policies and procedures

On 24 April 2023, the EPDP Team published its Phase 1 Initial Report for Public Comment, which closed on 19 June 2023.⁸ Twelve submissions were received during the Public Comment period. Following a review of the submissions, the EPDP Team finalized sixty-nine (69) recommendations, some of which also include implementation guidance. While the majority of the recommendations were finalized without substantive change, one notable change is that the term "IDN" has been removed from almost all recommendations. The EPDP Team agreed that this change was necessary to future-proof the policy recommendations against the possibility that any update to the RZ-LGR could result in allocatable variant labels being created from ASCII code points.⁹ The term "IDN" term remains in two of the recommendations as they explicitly relate to existing IDN gTLDs delegated as a result of the 2012 New gTLD Program (e.g., [Final Recommendations 3.14 and 3.15](#)).

During the review of Public Comment, the EPDP Team noted concerns raised by some commenters that several recommendations did not align with the conservatism principle (e.g., [Final Recommendations 3.11, 3.12, and 8.1](#)).¹⁰ After extensive discussion, the EPDP Team agreed not to change those recommendations, but did agree to enhance other recommendations concerning the evaluation of variant gTLD applications (e.g., [Final Recommendation 3.5, Implementation Guidance 3.6 and 3.9](#)). This approach is intended to strike a balance that will encourage and support the introduction of variant gTLDs while also promoting the security and stability of the Domain Name System.

Readers are encouraged to review the glossary provided in Section 3 first as this will help readers gain familiarity and understanding of the key terms and phrases that are frequently used throughout this Phase 1 Final Report.

The consensus call on the recommendations contained in this Final Report, as required by the GNSO Working Group Guidelines, was carried out by the EPDP Team, as described in the Annex C: Consensus Designations. In summary, all of the sixty-nine (69) final recommendations received "full consensus" support from the EPDP Team. For further details about these designations, please see Section VI: Decision Making Methodologies in the EPDP Team charter contained in Annex B.

⁸ See Public Comment proceeding of the Phase 1 Initial Report here: <https://www.icann.org/en/public-comment/proceeding/phase-1-initial-report-on-the-internationalized-domain-names-epdp-24-04-2023>

⁹ Based on calculation of the latest RZ-LGR version 5, an ASCII gTLD string currently does not have any allocatable variant labels that can be delegated into the root zone; an IDN gTLD may have allocatable variant labels that can also be delegated. As such, the majority of the EPDP Team recommendations and implementation guidance are currently envisaged to be only applicable to IDN gTLDs.

¹⁰ The EPDP Team explained the conservatism principle as follows: Adopt a more cautious approach in the gTLD policy development as a way to limit any potential security and stability risks associated with the variant label delegation. See more detailed explanation in Section 3: Glossary.

1.3 Conclusions and Next Steps

This Phase 1 Final Report will be submitted to the GNSO Council for consideration. If the Final Report is approved by the GNSO Council, it will be forwarded to the ICANN Board of Directors for consideration and potential action in accordance with the ICANN Bylaws.

The EPDP-IDNs Team will continue its deliberations on Phase 2 charter questions in accordance with its project plan and timeline.

1.4 Other Relevant Sections of this Report

The following sections are included within this Phase 1 Final Report:

- Explanation of the EPDP Team’s methods and process for reaching final recommendations, including summary of the Public Comment review outcomes;
- Glossary that provides definitions of the terms and phrases frequently used throughout this report;
- Compilation of all Phase 1 final recommendations, some of which include corresponding implementation guidance, and their rationale;
- Explanation of recommendations on topics covered by both EPDP-IDNs and ccPDP4 where differences exist;
- EPDP Team charter;
- EPDP Team’s high level responses to Phase 1 charter questions;
- Background on the EPDP and issues under consideration;
- Documentation of who participated in the EPDP Team’s deliberations, including attendance records, and links to their Statements of Interest as applicable;
- Documentation on the solicitation of community input through formal Supporting Organization/Advisory Committee and Stakeholder Group/Constituency channels and responses, as well as the Public Comment proceeding.

2 EPDP Team Approach

This section provides an overview of the working methodology and approach of the EPDP Team. The points outlined below provide background information on the EPDP Team's deliberations and processes, but do not represent the entirety of the efforts and deliberations of the EPDP Team.

2.1 Project Plan

One of the EPDP Team's first deliverables was to produce a project plan, setting out the anticipated time frame for deliberations on the charter topics and target dates for key milestones. The project plan was provided to the GNSO Council for its consideration during the October 2021 Council meeting.¹¹

In late 2022, the EPDP Team determined that in order to support implementation planning of the New gTLD Subsequent Procedures (SubPro) PDP Outputs, it would be helpful to bifurcate its work into two phases, with Phase 1 covering topics related to top-level gTLD definition and variant management, and Phase 2 covering issues pertaining to second-level variant domain management. The EPDP Team recognized that this approach did not remove the interaction of its Phase 2 work with the SubPro implementation, as many second-level-related charter questions may have impact on the New gTLD Program. The EPDP Team also determined that a timeline extension was necessary due to the diversity and complexity of variant issues, additional data collection needs, review of ICANN org input for draft recommendations, and Public Comment-related processes. The EPDP Team submitted a Project Change Request to the GNSO Council, which the Council adopted on 17 November 2022.¹² The EPDP Team updated the project plan accordingly, estimating the delivery of Phase 1 Final Report to the GNSO Council in November 2023 and the delivery of Phase 2 Final Report in November 2025.¹³

On 16 March 2023, the ICANN Board requested that the EPDP Team deliver an updated project plan by 15 June 2023 that identifies all charter questions that will impact the next Applicant Guidebook (AGB) of the New gTLD Program.¹⁴ Following the publication of its Phase 1 Initial Report in April 2023 for Public Comment, the EPDP Team conducted a thorough analysis of its charter questions and consulted with relevant ICANN org department for input. On 25 May

¹¹ Original project plan (September 2021 version):

https://community.icann.org/download/attachments/181306993/EPDP_IDN_Project_Plan_20210928.pdf?version=1&modificationDate=1638415613000&api=v2

¹² Project Change Request:

<https://community.icann.org/download/attachments/181306993/Project%20Change%20Request%20Form%20-%20IDNs%20EPDP.pdf?version=1&modificationDate=1668662322000&api=v2>. GNSO Council resolution to adopt the Project Change Request: <https://gns0.icann.org/en/council/resolutions/2020-current#202211>

¹³ Updated project plan (November 2022 version):

https://community.icann.org/download/attachments/181306993/EPDP_IDN_Project_Plan_20221107.pdf?version=1&modificationDate=1668662265000&api=v2

¹⁴ See the ICANN Board resolution for detail: <https://www.icann.org/en/board-activities-and-meetings/materials/approved-resolutions-regular-meeting-of-the-icann-board-16-03-2023-en>

2023, the EPDP Team reported to the GNSO Council that nearly all of its charter questions may have an impact on the next AGB. As such, the EPDP Team determined not to reorganize its work but continue its two-phased approach; the estimated timeline for project completion was unchanged.¹⁵ In the meantime, the EPDP Team requested a dedicated face-to-face workshop to expedite its Phase 2 deliberations; this request received support from the GNSO Council and ICANN org in June 2023. During ICANN77, the GNSO Council submitted this deliverable to the ICANN Board, noting the caveat that a revised schedule would be delivered by taking into account several important factors that may shorten the EPDP's overall timeline.¹⁶

On 20 July 2023, the EPDP-IDNs Team provided the GNSO Council with a revised timeline after considering the following factors: 1) progress made on Phase 2 charter question deliberation while the Phase 1 Initial Report Public Comment was ongoing; 2) the breadth and quantity of Public Comment received; and 3) the approval of the dedicated face-to-face workshop in December 2023.¹⁷ While there was no change to the timeline for delivering the Phase 1 Final Report, the EPDP Team shortened the Phase 2 timeline by 13 months, with the estimated delivery date of the Phase 2 Final Report in October 2024. The GNSO Council submitted this updated timeline to the ICANN Board and ICANN org on 25 July 2023.¹⁸

2.2 Community Input

In accordance with GNSO expedited policy development process requirements, the EPDP Team sought written input on the charter topics from each Supporting Organization, Advisory Committee, and GNSO Stakeholder Group and Constituency. The input received was incorporated into the EPDP Team's deliberations as each topic was discussed.¹⁹ Where groups that provided written input also had representative members on the EPDP Team, those members were well positioned to respond to clarifying questions from other members about the written input as it was considered.

While the Security and Stability Advisory Committee (SSAC) did not appoint members to the EPDP Team, its subject matter experts on IDNs met with the EPDP Team during two engagement sessions to discuss their views on specific charter questions and preliminary recommendations.²⁰ Some of the SSAC inputs were recorded in SAC120, which was published in April 2022.²¹ In addition, the EPDP Team conducted an outreach webinar for the Governmental

¹⁵ See EPDP-IDNs Team's presentation to the GNSO Council here: <https://gns0.icann.org/sites/default/files/policy/2023/presentation/epdp-idns-p2-project-plan-timeline-25may23-en.pdf>; to learn more, check the [transcript](#) and [recording](#) of the GNSO Council meeting on 25 May 2023.

¹⁶ See details in the GNSO Council deliverable submitted during ICANN77 here: <https://www.icann.org/en/system/files/correspondence/ducos-to-sinha-15jun23-en.pdf>

¹⁷ See EPDP-IDNs Team's presentation to the GNSO Council here: <https://community.icann.org/download/attachments/240615630/20%20July%202023%20GNSO%20Council%20-%20EPDP-IDNs%20.pdf?version=1&modificationDate=1689606104000&api=v2>; to learn more, check the [transcript](#) and [recording](#) of the GNSO Council meeting on 20 July 2023.

¹⁸ See the updated GNSO Council deliverable here: <https://www.icann.org/en/system/files/correspondence/ducos-to-sinha-25jul23-en.pdf>

¹⁹ See the community early input received here: <https://community.icann.org/display/epdpidn/Community+Input>

²⁰ SSAC engagement session in [January 2022](#) and [May 2023](#)

²¹ SAC120: <https://www.icann.org/en/system/files/files/sac-120-en.pdf>

Advisory Committee (GAC) in February 2023, briefing the GAC on issues regarding variants and explaining the significance of the EPDP Team’s work.²²

Community input was also sought through Public Comment on the EPDP Team’s Phase 1 Initial Report, and the Public Comment period was open from 24 April to 19 June 2023.²³ In May 2023, the EPDP Team held a community webinar to raise awareness of its Phase 1 Initial Report and encourage community input.²⁴ By the Public Comment closure date, the EPDP Team received input from twelve (12) submissions.²⁵

2.3 Methodology for Deliberations

The EPDP Team began its deliberations on 11 August 2021. The EPDP Team agreed to continue its work primarily through conference calls scheduled weekly, in addition to email exchanges on its mailing list. The EPDP Team held sessions during ICANN72, ICANN73, ICANN74, ICANN75, ICANN76, ICANN77, and ICANN78 public meetings. These sessions provided an opportunity for the broader community to contribute to the EPDP Team’s deliberations on the charter topics being discussed.

All of the EPDP Team’s work is documented on its wiki workspace.²⁶ It includes its meetings, mailing list, meeting notes, deliberation summaries, draft documents, background materials, and early input received from ICANN community groups and ICANN org.²⁷

The EPDP Team used a methodical approach to deliberations and drafting. The charter questions were sorted and ordered based on anticipated dependencies between the topics. Due to the complexity of the subject matter, for each charter question, staff first provided background and context to support deliberations and help frame the questions. The EPDP Team then deliberated on the charter question until the group reached high-level agreement on the approach to the related recommendations. The leadership team, in collaboration with staff, drafted responses to charter questions and recommendations in batches based on these high-level agreements. EPDP Team members reviewed these drafts with their representative groups and provided comments and suggested revisions, where appropriate. The EPDP Team then conducted a second reading of each batch, making any necessary adjustments to the text. Following completion of these steps, a section of draft text was considered stable and ready to be included in the Initial Report.

In addition, as String Similarity Review was one of the most challenging topics for the EPDP Team, a dedicated small group was established to develop concrete examples of confusingly

²² GAC outreach session in [February 2023](#) and May 2023

²³ <https://www.icann.org/en/public-comment/proceeding/phase-1-initial-report-on-the-internationalized-domain-names-epdp-24-04-2023>

²⁴ See recording of the community webinar here: <https://community.icann.org/x/HldXDg>

²⁵ Learn more about the Public Comments received for the Phase 1 Initial Report here: <https://community.icann.org/x/Y5GZDg>

²⁶ Wiki space here: <https://community.icann.org/pages/viewpage.action?pageId=176622687>

²⁷ Mailing list archives can be found at <https://mm.icann.org/pipermail/gnso-epdp-idn-team/>

similar strings and develop a recommendation on possible modifications to the String Similarity Review that takes into account the introduction of variant labels.²⁸

After the closure of the Public Comment period of its Phase 1 Initial Report, the EPDP Team reviewed all of the input received, using the Public Comment Review Tool developed by policy support staff.²⁹ The EPDP Team took into account the comments and finalized the recommendations using the same drafting method, which was used during its development of preliminary recommendations included in the Initial Report, as explained above.

While the Public Comments did not raise any significant concerns or many new issues that the EPDP Team had not previously considered, the EPDP Team sought guidance from the GNSO Council with regard to four submissions about the potential challenge faced by the “.québec” string application.³⁰ The GNSO Council agreed with the EPDP Team’s assessment that those comments were outside the scope for the EPDP to address.³¹

2.4 Use of Working Documents and Draft Output Documents

The EPDP Team used a series of working documents and draft output documents, organized per charter topic, to support deliberations and production of outputs. Archives of the documents are maintained on the EPDP Team’s wiki.

Working documents captured summaries of the deliberations on each charter question. These documents were updated on an ongoing basis and served as a point of reference for the evolving discussions on each topic. Draft output documents captured draft responses to charter questions and draft recommendations and implementation guidance, as well as their rationale.

In the process of developing the Phase 1 Final Report, the EPDP Team directly reviewed draft sections of the Final Report that included revisions to recommendations proposed by the leadership team in collaboration with staff. As a result of the Public Comment review, the majority of the recommendations were finalized without substantive changes and the Final Report was populated by similar content from the Initial Report. Hence, it was efficient to directly circulate the draft sections of the Phase 1 Final Report to the EPDP Team for discussion.

2.5 Data and Metrics

²⁸ Learn more about the String Similarity small group’s tasks in its assignment form here:

<https://community.icann.org/display/epdpidn/2022-05-18+IDNs+EPDP+String+Similarity+Review?preview=/197266252/197266624/String%20Similarity%20Review%20Small%20Group%20Assignment%20Form.pdf>

²⁹ Find the Public Comment Review Tool here: https://docs.google.com/spreadsheets/d/13s_6L-bRx6fslI34QR-65lbqjmqFU8GH2_b8X-8Qsjc/edit#gid=6303388

³⁰ The comments in question were submitted by: [Nacho Amadoz on behalf of Amadeu Abril i Abril](#), [Louis Houle](#), [Normand Fortier](#), and [Claude Menard](#)

³¹ See the GNSO Council Guidance statement on “.québec” related comments here:

<https://mm.icann.org/pipermail/council/attachments/20230914/100d9b25/GNSOCouncilGuidanceStatementon.qube-c-0001.pdf>

As required by the EPDP Team charter, the EPDP Team identified areas where data and metrics would help to inform the EPDP Team’s deliberations on particular charter questions. Where ICANN org was in a position to collect and analyze relevant data, subject matter experts from ICANN org assisted the EPDP Team with these tasks.

By way of example, to support EPDP Team’s consideration of the timing and mechanism by which existing registry operators from the 2012 round could apply for their variant labels in the future, ICANN org helped the EPDP Team develop and distribute a survey targeting registry operators of thirty-five (35) Chinese gTLDs and nine (9) Arabic gTLDs that have allocatable variant labels according to the RZ-LGR calculation.³² To facilitate the EPDP Team’s deliberations on possible modifications to the String Similarity Review, ICANN org helped conduct analysis of the theoretical number of string comparisons that would be completed using different approaches. The analysis used concrete examples and included visual aids to present abstract concepts and use cases.³³ Furthermore, the EPDP Team conducted an outreach to the Chinese, Japanese, and Korean General Panels and requested their input regarding the evaluation of single-character gTLD applications in the Han script.³⁴

To prepare for its deliberations on Phase 2 charter questions regarding second-level variant domain management, the EPDP Team engaged with the GNSO Contracted Parties House TechOps team to gather relevant data. The EPDP Team will also draw on a research report that it requested and received from ICANN org on the languages and scripts used in the Trademark Clearing House (TMCH).

2.6 ICANN Org and Board Interaction

To promote a smooth transition from policy development to eventual implementation of GNSO Council-adopted and ICANN Board-approved recommendations, the EPDP Team has been supported by early and ongoing engagement with ICANN org subject matter experts. Liaisons from ICANN org’s Global Domains and Strategy (GDS) (Michael Karakash) and IDN and UA Program (Sarmad Hussain and Pitinan Kooarmornpatana) regularly attended EPDP Team calls, providing input and responding to questions where it has been possible to do so in real time. The liaisons passed on EPDP Team’s questions to ICANN org that required additional research or input. The liaisons also facilitated ICANN org subject matter experts’ review of EPDP Team’s Phase 1 draft recommendations as well as the preliminary recommendations that were published for Public Comment.³⁵

³² See survey result details here: <https://mm.icann.org/pipermail/gnso-epdp-idn-team/attachments/20220707/8091596c/ResultsofSurveytoArabicandChineseIDNgTLDRetryOperators-GoogleDocs-0001.pdf>

³³ See data visualization examples under the deliberation of Charter Question E3 in Section 4.4 and Annex A in this Final Report.

³⁴ See details under the deliberation of Charter Question A7 in Section 4.3 in this Final Report.

³⁵ In November 2022, ICANN org provided input from operational perspectives for a subset of draft recommendations that were considered stable: <https://mm.icann.org/pipermail/gnso-epdp-idn-team/attachments/20221116/c1e0a14b/IDNEPDPICANNOrgInput-16Nov22-0001.pdf>. The corresponding preliminary recommendations included in the Phase 1 Initial Report incorporated the ICANN org input.

In addition, the ICANN Board appointed two liaisons (the current liaisons are Edmon Chung and Alan Barrett; Akinori Maemura was a Board appointed liaison until his term on the ICANN Board ended in September 2022) who regularly attend EPDP Team calls and act as a conduit between the Board and the EPDP.

2.7 Coordination with ccNSO Policy Development Work on IDNs

Throughout its work, the EPDP Team has maintained lines of communication with the ccPDP4 Working Group, which is conducting policy development work on IDN ccTLDs. These communications focus on topics which appear in the charters of both the EPDP-IDNs and ccPDP4, namely the area of variant management and String Similarity Review. The goal of this communication is to meet the ICANN Board’s request that the GNSO and the ccNSO keep each other informed of the progress in developing the relevant policies and procedures to ensure a consistent solution for variant gTLDs and variant ccTLDs.

The use of liaisons between the groups (Dennis Tan Tanaka has been serving as the EPDP-IDNs liaison to ccPDP4 and Anil Jain as the ccPDP4 liaison to EPDP-IDNs) and bilateral meetings at key points in the work supported this coordination. As such, the two groups were able to recognize differences between draft outcomes as they were being developed, and to identify any potential issues if differences did exist.

In addition, both EPDP-IDNs and ccPDP4 included a section in their Initial Report, detailing their respective analysis of the recommendations under the topics covered by both groups where differences existed. The EPDP-IDNs updated the analysis in this Final Report after reviewing the ccPDP4’s Initial Report, which was published on 16 August 2023 for Public Comment.³⁶

2.8 Accountability to the GNSO Council

As is now the case with all GNSO working groups, the EPDP Team delivered monthly “project packages” to the GNSO Council to update the Council on the status and progress of its work. Details of the project schedule, attendance, and action items can be found in the monthly project packages. An archive of these packages is available on the wiki.³⁷

The leadership team of the EPDP (Donna Austin as the Chair and Justine Chew as the Vice Chair) have been invited to speak to the GNSO Council when it is timely to share any important updates or significant changes. The GNSO Council Liaison (Farell Folly) also served as an additional point of connection between the Council and the EPDP Team.

³⁶ Public Comment on the ccPDP4 Initial Report: <https://www.icann.org/en/public-comment/proceeding/ccns0-pdp4-initial-report-on-the-de-selection-of-idncctlds-16-08-2023>

³⁷ Wiki space here: <https://community.icann.org/pages/viewpage.action?pageId=176622687>

3 Glossary

The table below lists the key terms and phrases that are used throughout this Phase 1 Final Report covering topics related to gTLD definition and variant management at the top-level. The explanations of their meanings are developed based on the EPDP Team’s understanding of the existing body of work related to IDNs and the Team’s use of the terms in the context of the Phase 1 charter question deliberations. Additional notes are included to explain the common usage of certain terms and phrases in this Phase 1 Final Report.

The EPDP Team appreciates that some readers may consider the meaning of the terms as reflected in this glossary to be imprecise from a technical perspective. The Team understands that this is the case and it is for this reason the EPDP Team has not provided a definition, but rather the ‘meaning’ of the term as used and commonly understood by the Team.

The terms in this glossary are organized in alphabetical order. Some terms are cross referenced in multiple places in this glossary and they are italicized to facilitate reference.

Term	Meaning	Additional Notes on Usage
2012 Round	The 2012 application round of the New gTLD Program conducted by ICANN org. ³⁸	In this Phase 1 Final Report, this phrase is often mentioned when referring to the existing gTLDs delegated as a result of the 2012 round.
Allocatable	Determined by the <i>Root Zone Label Generation Rules (RZ-LGR)</i> , this is a <i>valid variant label</i> derived from a <i>primary label</i> that is eligible to be a top-level domain and available for application, allocation, and eventual delegation.	This term is used to describe a <i>variant label’s disposition value</i> in accordance with RZ-LGR. It usually appears in the phrase “allocatable variant label(s)”.
Allocated	The label state of a top-level domain that is administratively assigned to the entity that has applied for the label upon approval of the entity’s application for the label.	This is one of the five <i>label states</i> discussed in Charter Questions A9 and A10. It means the state of a label prior to its <i>delegation</i> as a top-level domain in the Domain Name System. This term sometimes appears alongside “delegated” in several

³⁸ Learn more: <https://gnso.icann.org/sites/default/files/file/field-file-attach/annex-4-epdp-manual-15mar23-en.pdf>

Term	Meaning	Additional Notes on Usage
		recommendations with respect to the management of variant labels that have been allocated and delegated at the top-level.
Applicant Guidebook (AGB)	In the New Generic Top-Level Domain Program (New gTLD Program), the AGB is the document that describes the requirements of the new gTLD application and evaluation processes. ³⁹ The current version is the one published on 4 June 2012 for the 2012 New gTLD Program. It is often referred to as the “2012 Applicant Guidebook” or the “2012 AGB” in short.	This term is referenced in various charter questions, as this EPDP Team is expected to develop recommendations that build on the existing work of the SubPro PDP and address gaps, including how to operationalize SubPro PDP recommendations in the New gTLD Program; the Applicant Guidebook is a crucial vehicle to operationalize those recommendations. The EPDP Team generally agreed with SubPro’s affirmation or modification to the 2012 AGB; as such, AGB is mentioned in several EPDP final recommendations.
Blocked	<p>Determined by the RZ-LGR, this is a <i>valid</i> variant label derived from a <i>primary label</i> that is not eligible for allocation or delegation as a top-level domain.</p> <p>This is also a label state of a top-level domain that is not eligible for allocation or delegation into the root zone.</p>	<p>This term is used to describe a variant label’s <i>disposition value</i> in accordance with RZ-LGR. It usually appears in the phrase “blocked variant label(s)”.</p> <p>This is also one of the five <i>label states</i> discussed in Charter Questions A9 and A10.</p> <p>In the context of this Phase 1 Final Report, a “blocked” label refers to either:</p> <ul style="list-style-type: none"> • A label within the same script that is deemed valid as a top-level domain by the RZ-LGR but unavailable for allocation or delegation; or

³⁹ Download it here: <https://newgtlds.icann.org/en/applicants/agb>

Term	Meaning	Additional Notes on Usage
		<ul style="list-style-type: none"> • A mixed-script blocked label permitted by the RZ-LGR as an exception (i.e., only Japanese has such an exception). <p>To be clear, the “blocked” variant labels in this Phase 1 Final Report do not include the labels created by mixing different scripts. Such mixed-script labels are not eligible to be top-level domains with the exception of Japanese.</p>
ccPDP4	The abbreviation of the Country Code Names Supporting Organization (ccNSO) Policy Development Process 4 on the (de-)Selection of IDN ccTLD Strings.	<p>The ccPDP4 Working Group is conducting policy development work on IDN ccTLDs, including in the area of variant management and string similarity review.</p> <p>Section 5 of this Phase 1 Final Report focuses on recommendations on topics covered by both EPDP-IDNs and ccPDP4 where differences exist.</p>
Conservatism	A principle agreed upon by the EPDP Team in respect of gTLD policy development for the management of the root zone, and in particular, for the introduction of gTLD variant labels. This principle advocates for the adoption of a more cautious approach as a way to limit any potential security and stability risks associated with the variant label delegation in the absence of data or information in support of a more liberal approach. It is consistent with RFC 6912 which says, “doubts should always be	<p>The EPDP Team abided by this principle in developing an overall conservative approach for the introduction of gTLD variant labels at the top-level. For example, this principle is notably reflected in the final recommendations on the evaluation of variant label applications (e.g., Final Recommendations 3.5, 4.1-4.3, Implementation Guidance 3.6, 3.9, etc.). The application of the conservatism principle is not absolute in all of the EPDP-IDNs final recommendations. Some recommendations (e.g., Final Recommendations 3.11-3.12, 8.1, etc.) may be perceived to be less than conservative, and they are</p>

Term	Meaning	Additional Notes on Usage
	resolved in favor of rejecting”. ⁴⁰ This principle has been upheld by numerous studies and advice throughout the years. ⁴¹	part of the balancing act to incentivize gTLD variant label applications while achieving the security and stability goal.
Delegated	The label state of a top-level domain that has been placed in the root zone of the Domain Name System, which then facilitates the registry operator’s ability to commence the process of bringing the registry service into production. ⁴²	This is one of the five <i>label states</i> addressed in Charter Questions A9 and A10. It is the subsequent state of a label after it has been <i>allocated</i> to the entity that has applied for the label. This is also an application state in the New gTLD Application process. This term appears alongside “allocated” in several recommendations with respect to the management of variant labels that have been allocated and delegated at the top-level.
Denial of Service / No-Connection	A failure mode, as defined in SAC060. The following scenario serves as an example: a user attempts to visit http://example.Y , reading it as being the same as the http://example.X that, for example, he or she saw in an advertisement, but the connection does not work	The mitigation of denial of service / no-connection was extensively considered by the EPDP Team in the context of Charter Question E3 about String Similarity Review; further discussion is documented in Annex A.

⁴⁰ <https://www.rfc-editor.org/rfc/rfc6912#page-7>

⁴¹ For example, RFC 5891 says that any domain name registry, including that of the root zone, should develop and apply additional restrictions as needed to reduce confusion and other problems (part of IDNA2008 standard). RFC 6921 notes that zones higher in the DNS tree tend to have more restrictive rules and the context is that the root zone serves the entire Internet population. SAC089 explains that confusability cannot be considered in isolation from other issues related to security; phishing and other social engineering attacks based on domain name confusion are a security problem for end users. The Staff Paper emphasizes that the variant implementation must be done in a way that operation and maintenance of the DNS not be adversely impacted by the introduction of gTLD variant labels; it should avoid including TLD variant labels in a manner that would create user vulnerabilities or a probability of confusion.

⁴² This is a technical definition of “delegated”: A status of some label with respect to a zone, indicating that in that zone there are NS resource records at the label. The NS resource records create a zone cut, and require an SOA record for the same owner name and corresponding NS resource records in the subordinate zone. The act of entering the NS records in the zone at the parent side of the zone cut is delegation, and to do that is to delegate. This definition is largely based on RFC 1034: <https://www.rfc-editor.org/rfc/rfc1034>

Term	Meaning	Additional Notes on Usage
	<p>because <code>http://example.X</code> is not registered.</p> <p>This term should not be confused with Distributed Denial of Service (DDOS).</p>	
Disposition Value	The disposition value of a variant label, as calculated by the RZ-LGR based on its <i>primary label</i> , can be either <i>allocatable</i> or <i>blocked</i> .	
EPDP	The abbreviation of Expedited Policy Development Process. It differs from the <i>Policy Development Process (PDP)</i> mainly in that an Issue Report and the associated Public Comment process are not needed. The Expedited Policy Development Process itself is described in Annex 4 of the GNSO Operating Procedures. ⁴³	This term usually appears in the phrases “EPDP-IDNs” and “EPDP Team”.
Generation Panel (GP)	A group of community volunteers who work together to create a proposal for a set of <i>Root Zone Label Generation Rules (RZ-LGR)</i> for a specific script or writing system. ⁴⁴	
Hybrid Model	A major recommendation from the EPDP Team on the modification to the String Similarity Review in approaching the introduction of gTLD variant labels as described in EPDP Team Final Recommendations 4.1-4.3.	This topic is specifically addressed in Charter Question E3 about String Similarity Review (see Section 4.4). Additional details are included in Annex A.

⁴³ See Annex 4 of the GNSO Operating Procedure here: <https://gns0.icann.org/sites/default/files/file/field-file-attach/annex-4-epdp-manual-15mar23-en.pdf>

⁴⁴ A Generation Panel is composed of individuals with experience or interest in the language, writing system, or script used by a particular community of Internet users. To begin development of an RZ-LGR, the GP must meet certain requirements and obtain approval from the ICANN organization. When a GP completes its work, it delivers the proposed RZ-LGR to the Integration Panel (IP), which reviews the proposal and then integrates it into the RZ-LGR. Learn more about Generation Panel here: <https://www.icann.org/resources/pages/generation-panel-2015-06-21-en>

Term	Meaning	Additional Notes on Usage
Implementation Review Team (IRT)	A team led by ICANN org staff and consisting of community volunteers who assist in the implementation of the ICANN Board approved policy recommendations from GNSO <i>Policy Development Processes (PDPs)</i> . ⁴⁵	This term is often referenced in the context of implementing the Outputs from the New gTLD Subsequent Procedures Policy Development Process (SubPro PDP); the SubPro IRT is mentioned in many charter questions of this EPDP. When the charter was drafted, there was an expectation that the SubPro IRT and the EPDP Team would coordinate on addressing overlapping issues. However, coordination has not been possible because the SubPro IRT did not start its work until May 2023. ⁴⁶
Integrity of the Set	A principle agreed upon by the EPDP Team where the relationship between a <i>primary label</i> and its <i>allocatable</i> and <i>blocked</i> variant labels shall not be infringed upon as long as the <i>primary label</i> exists. In other words, it stresses that the <i>primary label</i> determines the <i>variant label set</i> using RZ-LGR, as well as the indivisibility of a <i>variant label set</i> centered around the <i>primary label</i> . The <i>variant labels</i> derived from the <i>primary label</i> cannot be changed unless the calculation of the RZ-LGR changes. If the <i>primary label</i> ceases to exist, the <i>variant label set</i> will also cease to exist.	

⁴⁵ For more details, see Consensus Policy Implementation Framework (CPIF):

https://www.icann.org/uploads/ckeditor/CPIF_v2.0_2019CLEAN.pdf and the IRT Principles and Guidelines: <https://www.icann.org/en/system/files/files/irt-principles-guidelines-23aug16-en.pdf>

⁴⁶ On 16 March 2023, the ICANN Board adopted a substantial portion of the New gTLD Subsequent Procedures (SubPro) PDP Outputs and officially kicked off implementation efforts to prepare for launching the next application round of the New gTLD Program. The Outputs adopted by the ICANN Board include all the IDN-related recommendations in Topic 25 of the Final Report. See ICANN Board resolution here:

<https://www.icann.org/en/board-activities-and-meetings/materials/approved-resolutions-regular-meeting-of-the-icann-board-16-03-2023-en>

Term	Meaning	Additional Notes on Usage
Internationalized Domain Name (IDN) gTLD	A generic top-level domain label which contains characters other than ASCII letters, digits, or hyphens. Because IDN gTLDs support the use of Unicode characters, they can include characters from local languages and scripts. For example, [실례.테스트] is a domain name composed entirely of Hangul characters. Technically speaking, an IDN gTLD has the A-label form which consists of "xn--" followed by a valid punycode or else consists of a valid U-label, as per IDNA2008.	<p>In the Phase 1 Initial Report, this term appeared in a majority of the preliminary recommendations. Based on calculation of the latest RZ-LGR version 5, an ASCII gTLD string currently does not have any allocatable variant labels that can be delegated into the root zone; an IDN gTLD may have allocatable variant labels that can also be delegated. As such, the majority of the EPDP Team recommendations and implementation guidance are envisaged to be only applicable to IDN gTLDs.</p> <p>However, after considering input received from Public Comment on its Phase 1 Initial Report, the EPDP Team agreed to remove the mention of "IDN" in its recommendations. This approach is to future-proof potential updates to the RZ-LGR, in the event that allocatable variant labels are created from ASCII code points. In addition, this approach is also in recognition that RZ-LGR is applicable to all gTLDs, including ASCII gTLDs. This wording change has been incorporated consistently throughout this Final Report. Therefore, the term "IDN" rarely appears in the final recommendations, with the exception to the ones that specifically concern existing IDN gTLDs delegated as a result of the 2012 round (i.e., Final Recommendations 3.14-3.15).</p>
Label	The segments that are separated by dot characters in a domain	In this Phase 1 Final Report, this term usually appears in the

Term	Meaning	Additional Notes on Usage
	name. For example, the domain name gnso.icann.org consists of three labels: gnso, icann, and org.	phrase “variant label(s)” and is consistently used when referring to variants at the top-level. A <i>label</i> at the top-level is interchangeable with a <i>string</i> .
Label States	The states of the <i>variant labels</i> derived from the <i>primary label</i> which has been delegated into the root zone of the Domain Name System. Label states are expected to be used for tracking the states of variant labels and be applied to the different stages in the New gTLD Program as well as other processes (e.g., IDN ccTLD processes). The “ <i>delegated</i> ” and “ <i>allocated</i> ” label states also apply to the <i>primary label</i> .	This topic is specifically addressed in Charter Questions A9 and A10. The EPDP Team recommends five label states: <ul style="list-style-type: none"> ● <i>delegated</i>, ● <i>allocated</i>, ● <i>withheld / withheld-same-entity</i>, ● <i>blocked</i>, and ● <i>rejected</i>. Definitions of these label states are provided in this glossary.
Misconnection	A failure mode as defined in SAC060. The following scenario serves as an example: a user attempts to visit http://example.Y , reading it as being the same as the http://example.X that, for example, he or she saw in an advertisement, but arrives at a site controlled by a registrant different to that of http://example.X .	The mitigation of misconnection was extensively considered by the EPDP Team in the context of Charter Question E3 about String Similarity Review; further discussion is documented in Annex A.
New gTLD Program Reserved Name	A string that is reserved to maintain the exclusive rights to the names of ICANN, its bodies, or essential related functions of ICANN and IANA. For a full list of New gTLD Program Reserved Names, see Section 2.2.1.2.1 of	In this Phase 1 Final Report, “Reserved Name” is a shorthand reference of the “New gTLD Program Reserved Name”. This topic is specifically addressed in Charter Question E5 (see Section 4.3), and is relevant in Charter Question E3 about String Similarity Review (see Section 4.4).

Term	Meaning	Additional Notes on Usage
	the 2012 Applicant Guidebook. ⁴⁷ In addition, the SubPro PDP recommended adding “PTI” to the New gTLD Program Reserved Names list.	
PDP	The abbreviation of Policy Development Process. The Policy Development Process itself is described in Annex A of the ICANN Bylaws. ⁴⁸	
Primary (Label)	In the context of this Phase 1 Final Report, a <i>primary label</i> is the label that is the source for calculating the <i>variant label set</i> and determining its <i>variant labels</i> that are <i>allocatable</i> or <i>blocked</i> in accordance with the <i>RZ-LGR</i> . In the context of future new gTLD applications, a primary label is identified by the applicant as the main applied-for label that acts as a source against which variant labels and their disposition values are calculated using the <i>RZ-LGR</i> . For existing gTLD registry operators who apply for variant labels, their existing gTLDs will automatically become the primary label.	This term usually appears in the phrase “primary gTLD”. This term is often referenced in the context of the new gTLD application process, during which the applied-for string that is identified as the “primary label” plays a crucial role throughout the process. Once delegated, the gTLD that is identified as the “primary label” remains crucial in maintaining the integrity of the variant label set.
Rejected	The label state of a top-level domain label that is an allocatable variant label and applied-for as a top-level domain, but did not pass evaluation. The rejected state also encompasses the application states of “Not Approved” and	This is one of the five <i>label states</i> discussed in Charter Questions A9 and A10.

⁴⁷ All applied-for gTLD strings are compared with the list of Reserved Names to ensure that the applied-for gTLD string does not appear on that list. Furthermore, an application for a gTLD string that is identified as too similar to a Reserved Name will not pass the String Similarity Review. See more details in the 2012 Applicant Guidebook here: <https://newgtlds.icann.org/en/applicants/agb/guidebook-full-04jun12-en.pdf>

⁴⁸ See Annex A of ICANN Bylaws here: <https://www.icann.org/resources/pages/governance/bylaws-en/#annexA>

Term	Meaning	Additional Notes on Usage
	“Will Not Proceed” in the New gTLD Program. ⁴⁹	
Root Zone Label Generation Rules (RZ-LGR)	A set of rules that determine valid top-level domain labels, their variant labels, and disposition values of the variant labels. The RZ-LGR includes a list of permissible code points and variant code point mappings (if any) along with a set of rules that act on these code points and mappings. The latest version of the RZ-LGR is version 5, covering 26 scripts. ⁵⁰	This topic is specifically addressed in the charter questions under Topic A. Per EPDP Team <u>Final Recommendation 1.1</u> , the RZ-LGR is used as the sole source to determine valid strings as gTLDs and calculate variant labels and their disposition values. As such, this principle is reflected in a number of recommendations and the RZ-LGR is frequently mentioned.
Same Entity	<p>A principle agreed upon by the EPDP Team where at the top-level of the Domain Name System, the same registry operator must manage the approved labels from the <i>variant label set</i> of a <i>primary gTLD</i> from the application, legal, and operational standpoints.</p> <p>From the application standpoint, one application covers both the primary gTLD string and its allocatable variant labels; the applied-for labels from a variant label set go through the evaluation process together.</p> <p>From a legal standpoint, the Registry Agreement between the registry operator and ICANN org memorializes relationship between the approved labels from a variant label set; the <i>integrity of the set</i> must be maintained during the life of the</p>	This principle is reflected in a number of recommendations and the phrase “same entity” is frequently mentioned.

⁴⁹ See more information about the New gTLD Application states here:

<https://newgtlds.icann.org/en/applicants/advisories/application-contention-set-14mar14-en>

⁵⁰ Learn more about the RZ-LGR version 5 here: <https://www.icann.org/resources/pages/root-zone-lgr-2015-06-21-en>

Term	Meaning	Additional Notes on Usage
	<p>contract.</p> <p>From an operational standpoint, the management of the approved labels from a variant label set at the registry and registrar level aims to encourage a positive and predictable registrant experience.</p>	
Security and Stability Advisory Committee (SSAC)	<p>One of four Advisory Committees in the ICANN community. The SSAC advises the ICANN Board and the ICANN community on issues relating to the security and integrity of the Internet's naming and address allocation systems. Besides providing guidance on security matters during policy development, the SSAC monitors the Internet's naming and address allocation system for threats. The members of SSAC are appointed by the ICANN Board.⁵¹</p>	<p>This term is referenced in various charter questions, as well as in the rationale for several recommendations. Per charter requirements, the EPDP Team has been conducting its deliberations by building on the existing body of work on IDNs, including SSAC Advice relevant to IDNs, such as SAC052 and SAC060. In addition, the SSAC also published SAC120 that records the input for specific EPDP charter questions from the IDN-subject matter experts in the SSAC.</p>
Staff Paper	<p>A shorthand reference for the "IDN TLD Variant Management" paper developed by ICANN org.⁵² The Staff Paper includes a set of recommendations and supporting documentation on the mechanism for implementing variant TLDs. The ICANN Board approved these recommendations in March 2019 and requested that the GNSO and ccNSO take them into account while developing their respective policies to define and manage variant TLDs for the current TLDs and future TLD applications.</p>	<p>This term is referenced in various charter questions, as the ICANN Board directed the GNSO to develop recommendations by taking into account the recommendations and analysis in the Staff Paper. Some of the EPDP Team recommendations are consistent with the Staff Paper recommendations, whereas some differ.</p>
String	This term is interchangeable with	In this Phase 1 Final Report, this

⁵¹ Learn more: <https://www.icann.org/groups/ssac/meet-ssac-12aug10-en>

⁵² Read the Staff Paper here: <https://www.icann.org/resources/pages/idn-variant-tld-implementation-2018-07-26-en>

Term	Meaning	Additional Notes on Usage
	<p>a <i>label</i> at the top-level. See the meaning of “label” in this glossary.</p>	<p>term is consistently used when referring to the applied-for top-level domain. When referring to an existing top-level domain, only “gTLD” or “TLD” is used without attaching “string”.</p>
String Ineligible for Delegation	<p>A string that is ineligible for delegation in order to provide special protections at the top-level and second-level for the names and acronyms of intergovernmental organizations (IGOs) and international non-governmental organizations (INGOs) which receive protections under treaties and statutes across multiple jurisdictions. Those organizations specifically include the Red Cross/Red Crescent Movement (RCRC) and the International Olympic Committee (IOC).</p>	<p>This topic is specifically addressed in Charter Question E5 (see Section 4.3).</p>
Subsequent Procedures (SubPro)	<p>An abbreviation of the New gTLD Subsequent Procedures <i>Policy Development Process (PDP)</i>. The SubPro PDP Working Group was tasked to consider when and how to expand the number of generic top-level domains. The Working Group evaluated the 2012 application round to identify areas where additional policy development might be needed before launching another application round. It completed its deliberations and submitted its Final Report to the GNSO Council on 18 February 2021.⁵³ The Final Report includes hundreds of Outputs on 42 topics related to</p>	<p>This term is referenced in various charter questions, as this EPDP Team is expected to develop recommendations by building on the existing work of the SubPro PDP and addressing gaps, including whether the SubPro PDP Outputs should apply to existing gTLDs and how to operationalize SubPro PDP Outputs in the New gTLD Program. As a result, a number of EPDP Team recommendations and items of implementation guidance mention the relevant SubPro PDP recommendations and indicate that the EPDP Team affirms those recommendations.</p>

⁵³ SubPro PDP Final Report can be found here: <https://gns0.icann.org/sites/default/files/file/field-file-attach/final-report-newgtld-subsequent-procedures-pdp-02feb21-en.pdf>

Term	Meaning	Additional Notes on Usage
	the future of the New gTLD Program. Topic 25 of the Final Report focuses on IDNs. Most of the Topic 25 Outputs are pertaining to the definition and variant management mechanism of future gTLDs.	
Valid (Label)	The status of a label that is eligible to be a top-level domain as determined by the RZ-LGR.	
Variant Label	A <i>label</i> that can be registered in different ways due to variations in the spelling of words in a given language. For example, when registering a Chinese domain name, two versions of a character might exist in simplified and traditional Chinese or 名称 (Míngchēng, or name) and 名稱 (Míngchēng, or name) may be considered variant labels in Chinese. The set of rules in the <i>Root Zone Label Generation Rules (RZ-LGR)</i> determines valid top-level domain labels and their variant labels.	
Variant Label Set	The set of labels that is calculated by the RZ-LGR using the <i>primary label</i> . The variant label set consists of: <i>primary</i> label + <i>allocatable</i> variant label(s) + <i>blocked</i> variant label(s).	When this phrase is used in this Phase 1 Final Report, it refers to the entire variant label set in respect of the primary label.
Withheld / Withheld-same-entity	The label state of a top-level domain that is an <i>allocatable</i> variant label, but has not been applied-for as a top-level domain and has not yet been <i>allocated</i> or <i>delegated</i> into the root zone. It is set aside for possible allocation to the same entity that manages the <i>primary label</i> that is associated with the variant label.	This is one of the five <i>label states</i> discussed in Charter Questions A9 and A10.

4 Phase 1 Final Recommendations

In the Phase 1 of the EPDP-IDNs, the EPDP Team was tasked to provide the GNSO Council with recommendations on the top-level gTLD definition and variant management. In its current project plan, the EPDP Team identified the questions under the following topics in its charter to be addressed in Phase 1:⁵⁴

- Topic A: Consistent definition and technical utilization of RZ-LGR
 - Charter Questions A1-A10
- Topic B: “Same entity” at the top-level
 - Charter Question B1-B5
- Topic D: Adjustments in registry agreement, registry service, registry transition process, and other processes/procedures related to the domain name lifecycle
 - Charter Questions D1-D3, D8
- Topic E: Adjustments to string similarity review, objection process, string contention resolution, reserved strings, and other policies and procedures
 - Charter Questions E1-E7

The EPDP Team finalized sixty-nine (69) recommendations. Some recommendations have “implementation guidance” on how a recommendation should be implemented.⁵⁵ The EPDP Team also determined that for certain charter questions (i.e., A2, A4, A8, B3, B4a, E1, E6, E7), no corresponding recommendation is necessary and a brief explanation is provided. See Annex D for EPDP Team’s responses to all Phase 1 charter questions.

This Phase 1 Final Report states the level of consensus within the EPDP Team achieved for the different recommendations. In summary, all of the sixty-nine (69) final recommendations received “full consensus” support from the EPDP Team. Please see the “Annex C: Consensus Designation” section of this Final Report for details.

The EPDP Team’s review of the Public Comments submitted on the Phase 1 Initial Report resulted in the Phase 1 final recommendations. The comments received did not raise any significant concerns about the preliminary recommendations or many new issues that the EPDP Team had not previously considered during its deliberation.⁵⁶ As a result, the majority of

⁵⁴ EPDP Team’s current project plan (November 2022 version):

[https://community.icann.org/download/attachments/181306993/EPDP IDN Project Plan 20221107.pdf?version=1&modificationDate=1668662265000&api=v2](https://community.icann.org/download/attachments/181306993/EPDP_IDN_Project_Plan_20221107.pdf?version=1&modificationDate=1668662265000&api=v2)

⁵⁵ The EPDP Team strongly recommends the stated action in the implementation guidance, with a strong presumption that it will be implemented, but recognizes that there may exist valid reasons in particular circumstances to not take the recommended action exactly as described.

⁵⁶ The EPDP Team sought guidance from the GNSO Council with regard to four submissions about the potential challenge faced by the applicant for the “.québec” string (the comments in question were submitted by [Nacho Amadoz on behalf of Amadeu Abril i Abril](#), [Louis Houle](#), [Normand Fortier](#), and [Claude Menard](#)). The GNSO Council [agreed](#) with the EPDP Team’s assessment that those comments were outside the scope for the EPDP to address.

recommendations were finalized without substantive changes. Please see the “Public Comment Review” section under the rationale for additional details regarding whether and how the Public Comments shaped the final recommendations.

In this Phase 1 Final Report, the numbering of the final recommendations generally aligns with the preliminary recommendations in the Initial Report. The sequence of the charter questions and the corresponding final recommendations roughly follows the process flow of the New gTLD Program, starting with the application submission step and ending with the delegation of a gTLD string. At the time these recommendations were developed, the EPDP Team envisaged that only existing IDN gTLDs delegated as a result of the 2012 round would be impacted by six (6) of the sixty-nine (69) recommendations (i.e., [Final Recommendation 2.1](#), [3.3](#), [3.14](#), [3.15](#), [7.3](#), [7.6](#)), due to the calculation of RZ-LGR version 5. Furthermore, the charter questions and the corresponding final recommendations that establish some of the underlying principles that guided the EPDP Team’s deliberation are placed on top (e.g., [Final Recommendation 1.1](#), [2.1](#), [3.1](#)).

Specifically, the underlying principles agreed upon by the EPDP Team and reflected in the final recommendations include the following:

- **RZ-LGR as the Sole Source:** The RZ-LGR will be the sole source to determine valid top-level domain labels, their variant labels, and disposition values of the variant labels.
- **Same Entity:** At the top-level of the DNS, the same registry operator must manage the approved labels from the variant label set of a primary gTLD from the application, legal, and operational standpoints.
- **Integrity of the Set:** The relationship between a primary label and its allocatable and blocked variant labels shall not be infringed upon as long as the primary label exists.
- **Conservatism:** Adopt a more cautious approach in the gTLD policy development as a way to limit any potential security and stability risks associated with the variant label delegation.⁵⁷

The structure of the subsections that organize the final recommendations is as follows:

- [Section 4.1: RZ-LGR as the Sole Source](#)
- [Section 4.2: Same Entity Principle](#)
- [Section 4.3: Application Submission, Administrative Check, Initial Evaluation](#)
- [Section 4.4: String Similarity Review](#)
- [Section 4.5: Objection Processes](#)
- [Section 4.6: String Contention](#)
- [Section 4.7: Contractual Requirements](#)
- [Section 4.8: Delegation and Removal](#)

⁵⁷ See more detailed explanation of these underlying principles in Section 3: Glossary of this Final Report.

- [Section 4.9: Variant Label States](#)
- [Section 4.10: Charter Questions with No Recommendations](#)

Within the text of this document, the key words "MUST", "MUST NOT", "SHOULD", "SHOULD NOT", "SHALL", "SHALL NOT", "REQUIRED", and "MAY" are to be interpreted as described in RFC 2119.⁵⁸

⁵⁸ RFC 2119: <https://www.rfc-editor.org/rfc/rfc2119>

4.1 RZ-LGR as the Sole Source

A1 Charter Question:

Evaluating all TLDs using RZ-LGR as the one and only authoritative source allows for a consistent approach for reviewing current and future TLDs. The SubPro PDP, the Staff Paper, and the Study Group on Technical Use of RZ-LGR (“TSG”) recommend that compliance with RZ-LGR (RZ-LGR-4, and any future RZ-LGR versions) must be required for the validation of all future gTLDs (including IDN and ASCII labels) and the calculation of their variant labels as a matter of policy, including the determination of whether the disposition of the label should be blocked or allocatable.⁵⁹

For existing delegated gTLD labels, does the WG recommend using the RZ-LGR as the sole source to calculate the variant labels and disposition values?

A1 Final Recommendations:

Final Recommendation 1.1: The RZ-LGR must be the sole source to calculate the variant labels and disposition values for all existing gTLDs.

A1 Rationale for Final Recommendations:

Rationale for Final Recommendation 1.1: To support its consideration of charter question A1, the EPDP Team relied on data collected and analyzed by ICANN org that calculated the variant labels of existing gTLDs, which have been delegated as a result of the 2012 round, by using the version of the RZ-LGR available during its deliberation of this charter question (i.e. RZ-LGR version 4) and determined whether the variant labels match those that were identified by the applicants in the 2012 round.⁶⁰ The EPDP Team noted that as the RZ-LGR did not exist in 2012, the then IDN gTLD string applicants were asked to self-identify any “variant” labels (based on their own calculations) corresponding to their applied-for string. The EPDP Team concluded that there is no significant difference between the variant labels calculated by the RZ-LGR and those self-identified by applicants in 2012. Only two self-identified “variants” did not conform to the RZ-LGR: one likely related to an alternative spelling; and the other was potentially a typographical error. As a result, the EPDP Team concluded that using the RZ-LGR as the sole source to calculate variant labels of all existing gTLDs and their disposition values would not have a major impact on existing gTLD registry operators.

⁵⁹ See Recommendation 25.2 and Implementation Guidance 26.10 in the SubPro Final Report, pp.115, 119: <https://gnso.icann.org/sites/default/files/file/field-file-attach/final-report-newgtld-subsequent-procedures-pdp-02feb21-en.pdf#page=115>; Recommendation 1 in the Staff Paper, p.3: <https://www.icann.org/en/system/files/files/idn-variant-tld-recommendations-analysis-25jan19-en.pdf#page=3>; Recommendation 1 in the TSG report, p.5: <https://www.icann.org/en/system/files/files/rz-lgr-technical-utilization-recs-07oct19-en.pdf#page=5>

⁶⁰ See more details of the data collection exercise here: <https://community.icann.org/download/attachments/180028295/GNSO%20IDN%20EPDP%20Data-12nov21.xlsx?version=1&modificationDate=1637684496799&api=v2>

A1 Public Comment Review:

Wording Change: The EPDP Team accepted the suggested wording change raised in Public Comment that impacted a number of recommendations. It agreed to use “existing” when referring to all of the gTLDs that have been delegated in the root zone. The Team also agreed to remove "2012 round" from the recommendation language in recognition that the RZ-LGR is applicable to all gTLDs, including existing ASCII gTLDs delegated prior to the 2012 round. This wording change has been incorporated consistently throughout this Final Report.

4.2 Same Entity Principle

B1 Charter Question:

Both the SubPro PDP and the Staff Paper recommend that variant TLDs that ICANN delegates must have the “same entity” as the sponsoring organization and the “Registry Operator” be used as the definition of the “same entity” at the top-level. Should this recommendation be extended to existing TLDs?

B1 Final Recommendations:

Final Recommendation 2.1: Any allocatable variant label of an existing gTLD, as calculated by the RZ-LGR, can only be allocated to the same registry operator or withheld for possible allocation only to that registry operator.

B1 Rationale for Final Recommendations:

Rationale for Final Recommendation 2.1: To support its consideration of charter question B1, the EPDP Team reviewed the SubPro PDP Recommendation 25.5 and Staff Paper Recommendation 2, as well as their rationale.⁶¹ The EPDP Team agreed that abiding by the “same entity” principle and having the same registry operator for all allocatable variant labels of an existing gTLD will help minimize, but not eliminate, the security risk associated with the “failure modes” – including denial of service / no-connection and misconnection – when dealing with variant labels.⁶² Therefore, the EPDP Team agreed to extend the SubPro PDP and the Staff Paper recommendations to existing gTLDs. At the time this recommendation was developed, it was envisaged that only existing IDN gTLDs delegated as a result of the 2012 round would be impacted, based on the calculation of RZ-LGR version 5.⁶³

B1 Public Comment Review:

Wording Change: The EPDP Team accepted the suggested wording change raised in Public Comment that impacted a number of recommendations. It agreed to remove the mention of “IDN” in order to future-proof potential updates to the RZ-LGR, in the event that allocatable variant labels are created from ASCII code points. This wording change has been incorporated consistently throughout this Final Report. In addition, the EPDP Team agreed to add clarification

⁶¹ See Recommendation 25.5 in the SubPro PDP Final Report, p.115:

<https://gnso.icann.org/sites/default/files/file/field-file-attach/final-report-newgtld-subsequent-procedures-pdp-02feb21-en.pdf#page=115>; Recommendation 2 in the Staff Paper, p.3:

<https://www.icann.org/en/system/files/files/idn-variant-tld-recommendations-analysis-25jan19-en.pdf#page=3>; rationale for Recommendation 25.5 in the SubPro PDP Final Report, p.117:

<https://gnso.icann.org/sites/default/files/file/field-file-attach/final-report-newgtld-subsequent-procedures-pdp-02feb21-en.pdf#page=117>; Section 3.2 in the Staff Paper, pp.6-7: <https://www.icann.org/en/system/files/files/idn-variant-tld-recommendations-analysis-25jan19-en.pdf#page=6>

⁶² See Recommendation 7 of SAC060, p.14: <https://www.icann.org/en/system/files/files/sac-060-en.pdf#page=14>

⁶³ Based on the calculation by the latest RZ-LGR version 5, an ASCII gTLD does not have any allocatable variant labels that can be delegated into the root zone; an IDN gTLD may have allocatable variant labels that can also be delegated. As such, this recommendation, at the time it was developed, the EPDP Team envisaged that it would only impact existing IDN gTLDs. However, it does not preclude the possibility of impacting ASCII gTLDs, if a future version of the RZ-LGR includes allocatable variant labels created from ASCII code points.

in the rationale that at the time this recommendation was developed, it was envisaged that only existing IDN gTLDs delegated as a result of the 2012 round would be impacted, based on the RZ-LGR version 5 calculation. This clarification has been added in the rationale of several applicable recommendations.

4.3 Application Submission, Administrative Check, Initial Evaluation

B4 Charter Question:

The policy recommendation advises that variant TLD labels be allocated to the same entity, however a process to apply for a variant TLD does not exist. The WG and the SubPro IRT to coordinate and consider the following questions in order to develop a consistent solution: what should an application process look like in terms of timing and sequence for an existing and future Registry Operator with respect to applying or activating their allocatable variant TLD labels?

B4 Final Recommendations:

Final Recommendation 3.1: An application for an allocatable variant label cannot precede an application for that variant label's primary gTLD string.

Final Recommendation 3.2: A future registry operator who wishes to apply for an allocatable variant label of its existing gTLD must submit an application during an application round.

B4 Rationale for Final Recommendations:

Rationale for Final Recommendation 3.1: A label's status as a "variant" is determined by the primary gTLD, which serves as the source for calculating the variant label set and determining which variant labels are allocatable and which variant labels are blocked in accordance with the RZ-LGR. As such, the EPDP Team agreed that an allocatable variant label can only be applied for at the same time as its primary gTLD string, or subsequent to that primary gTLD being delegated. This requirement is to preserve the principle of the "integrity of the set", a phrase developed by the EPDP Team to describe the primary gTLD's crucial role in bringing the variant label set into existence, as well as the indivisibility of a variant label set centered around the primary gTLD.⁶⁴ This principle has been reflected in several EPDP Team's recommendations.

Rationale for Final Recommendation 3.2: For the avoidance of doubt, this recommendation specifically addresses potential applications for allocatable variant labels of future gTLDs that will be delegated in the root zone. This recommendation is complementary to [Final Recommendation 3.3](#), which seeks to address potential applications for allocatable variant labels of the existing gTLDs that have been delegated as a result of the 2012 round.

⁶⁴ Per Section 3: Glossary, "Integrity of the Set" means the following: a principle agreed upon by the EPDP Team where the relationship between a primary label and its allocatable and blocked variant labels shall not be infringed upon as long as the primary label exists. In other words, it stresses that the primary label determines the variant label set using RZ-LGR, as well as the indivisibility of a variant label set centered around the primary label. The variant labels derived from the primary label cannot be changed unless the calculation of the RZ-LGR changes. If the primary label ceases to exist, the variant label set will also cease to exist.

The EPDP Team affirmed the SubPro PDP’s recommendation that applications for new gTLDs “must be assessed in rounds”.⁶⁵ The EPDP Team also noted that another SubPro PDP recommendation requires clarity and predictability around the timing and/or criteria for initiating subsequent application rounds of the New gTLD Program.⁶⁶ In other words, regular intervals between application rounds are expected and indeterminate periods of time between application opportunities are unacceptable. As such, the EPDP Team understood that registry operators could adequately rely on application rounds to apply for variant labels.

In addition, as explained in the rationale for [Final Recommendation 3.3](#), the EPDP Team agreed that no separate process should be developed for existing registry operators to apply for variant labels of their existing gTLDs. In the same vein, the EPDP Team believes that the most expedient and cost effective path for future registry operators to apply for variant labels is through application rounds.

B4 Public Comment Review:

Wording Change: [Final Recommendations 3.1-3.2](#) incorporated the suggested wording change raised in Public Comment, as explained in the Public Comment Review section for [Final Recommendations 1.1-2.1](#):

- Use “existing” when referring to all of the gTLDs that have been delegated in the root zone.
- Refrain from mentioning “2012 round” in the recommendation language when referring to the existing gTLDs, as this may be perceived as limiting and can potentially cause misinterpretation.
- Remove the mention of “IDN” in order to future-proof potential updates to the RZ-LGR, in the event that allocatable variant labels are created from ASCII code points.

D1b Charter Question:

What should be the process by which an existing registry operator could apply for, or be allocated, a variant for its existing gTLD? What should be the process by which an applicant applying for a new IDN gTLD could seek and obtain any allocatable variant(s)? What should be the associated fee(s), including the application fees and annual registration fees for variant

⁶⁵ See Affirmation with Modification 3.1 in the SubPro PDP Final Report, p.20:

<https://gnso.icann.org/sites/default/files/file/field-file-attach/final-report-newgtld-subsequent-procedures-pdp-02feb21-en.pdf#page=20>

⁶⁶ See Recommendation 3.2 in the SubPro PDP Final Report, pp.20-23:

<https://gnso.icann.org/sites/default/files/file/field-file-attach/final-report-newgtld-subsequent-procedures-pdp-02feb21-en.pdf#page=20>

TLDs? Should any specific implementation guidance be provided?⁶⁷

D1b Final Recommendations:

Final Recommendation 3.3: Applications for allocatable variant labels of existing gTLDs can be submitted during the immediate next application round of the New gTLD Program and any subsequent rounds.

Final Recommendation 3.4: A future applicant applying for a primary gTLD string together with its allocatable variant label(s) in the same round is required to submit one application for the primary gTLD string and the variant label(s).

Final Recommendation 3.25: After submission of an application, the applicant is allowed to withdraw an applied-for variant label from that application, but is not allowed to add any other variant label that was not originally applied-for in that application. Only an applicant for a .Brand TLD string whose applied-for primary gTLD string is placed in a contention set is allowed to change its applied-for primary string and allocatable variant label(s) under the condition set out in SubPro PDP Recommendation 20.8.⁶⁸

Final Recommendation 3.5: In addition to explaining the mission and purpose of the applied-for primary gTLD string or existing gTLD, the applicant seeking one or more gTLD variant labels will describe the justification of such need. The justification given by the applicant shall at minimum provide the following information:

- 3.5.1 The meaning or intended meaning (for non-dictionary words) of each of the applied-for variant label(s), including sources;
- 3.5.2 Explanation of how the primary and variant labels are considered the same;
- 3.5.3 Explain the benefits and the user communities who will benefit from the introduction of the applied-for variant label(s); and
- 3.5.4 A description of the steps that the applicant will take to minimize the operational and management complexities of variant gTLDs and variant domain names that impact registrars, resellers and/or registrants.

⁶⁷ SubPro PDP did not have substantive discussion about this question. Some SubPro PDP members believe that allocatable variant labels gTLDs should be made available to IDN gTLD registry operators and applicants, with only limited procedures and costs in place. As these deliberations arose late in the SubPro PDP's life cycle, the group elected to only recommend the "same entity" principle for gTLD variant labels but refrained from providing recommendations on how gTLD variant labels can be obtained. However, SubPro includes in its recommendation that the "same entity" policy for the top-level must be captured in the relevant Registry Agreement. See Rationale for Recommendation 25.5 in the SubPro PDP Final Report, p.117: <https://gnso.icann.org/sites/default/files/file/field-file-attach/final-report-newgtld-subsequent-procedures-pdp-02feb21-en.pdf#page=117> and Recommendation 25.5 in the SubPro PDP Final Report, p.115: <https://gnso.icann.org/sites/default/files/file/field-file-attach/final-report-newgtld-subsequent-procedures-pdp-02feb21-en.pdf#page=115>

⁶⁸ See Recommendation 20.8 in the SubPro PDP Final Report, p.92:

<https://gnso.icann.org/sites/default/files/file/field-file-attach/final-report-newgtld-subsequent-procedures-pdp-02feb21-en.pdf#page=92>

Implementation Guidance 3.6: With respect to the evaluation of the information submitted per Final Recommendation 3.5:

3.6.1 The evaluation panel must include evaluators with relevant script expertise;

3.6.2 The evaluation panel should apply criteria based on a general standard of reasonableness and the criteria must be established during implementation;

3.6.3 Consistent with Recommendation 27.2 of the SubPro PDP Final Report, evaluation scores on the questions should be limited to a pass/fail scale (0-1 points only);

3.6.4 The applicant must pass each element to enable the applied-for variant label to proceed to the next stage of the application process; and

3.6.5 The evaluation outcome of any one applied-for variant label should not impact the evaluation outcome of any other applied-for variant label in the application (including the primary gTLD string).

Final Recommendation 3.7: A future applicant must be required to demonstrate its ability to manage the applied-for primary gTLD string and applied-for allocatable variant label(s) from both a technical and operational perspective. The same requirement applies to registry operators who wish to apply for allocatable variant label(s) of their existing gTLDs.

Implementation Guidance 3.8: The evaluation of capability to manage the variant label set should be closely tied to the overall technical capability evaluation. The evaluation should be based on measurable criteria including, but not limited to, the performance of Critical Functions with respect to second-level registrations under the primary gTLD string and the applied-for allocatable variant label(s).

Implementation Guidance 3.9: Within 15 months of the delegation of the first gTLD variant label and every 24 months thereafter, ICANN org should conduct research in order to identify whether any additional criteria or tests should be used, as part of the application process, to evaluate the technical and operational capability of an applicant to manage a variant label set at the registry level. ICANN org must offer the community an opportunity to provide input on the scope of the research to be undertaken, as well as any proposed outputs on additional criteria or tests, and such outputs should not be applied retroactively.

Final Recommendation 3.10: The fee structure associated with future applications that include variant label(s), and variant label applications from registry operators of existing gTLDs, must be consistent with the principle of cost recovery reflected in the 2012 Applicant Guidebook

and affirmed by the New gTLD Subsequent Procedures PDP.⁶⁹

Final Recommendation 3.11: A future applicant applying for a primary gTLD string and up to four (4) of that string's allocatable variant labels during an application round must incur the same base application fee as any other gTLD applicant who does not apply for variant labels in that round.

Final Recommendation 3.12: Any applicant applying for more than four (4) allocatable variant labels of a primary gTLD string in an application round may incur additional fees that ICANN org considers to be proportionate to any additional costs associated with evaluating the application and consistent with the cost recovery principle.

Final Recommendation 3.13: A future registry operator applying only for allocatable variant label(s) of its delegated primary gTLD must incur a discounted base application fee. ICANN org will decide on the discount based on what it considers to be proportionate to any costs associated with evaluating the application and consistent with the cost recovery principle.

Final Recommendation 3.14: If a registry operator from the 2012 round applies for up to four (4) allocatable variant labels of its existing IDN gTLD:

- 3.14.1 in the immediate next application round, the base application fee will be waived for that application as a one-time exception; or
- 3.14.2 in any application round subsequent to the immediate next application round, that application must incur a discounted base application fee as set out in Final Recommendation 3.13.

If a registry operator from the 2012 round applies for more than four (4) allocatable variant labels of its existing IDN gTLD:

- 3.14.3 in the immediate next application round, that application may incur additional fees as set out in Final Recommendation 3.12; or
- 3.14.4 in any application round subsequent to the immediate next application round, that application must incur a discounted base application fee as set out in Final Recommendation 3.13 AND may incur additional fees as set out in Final Recommendation 3.12.

Final Recommendation 3.15: As a one-time exception for the immediate next application round, applications for allocatable variant labels of existing IDN gTLDs from the 2012 round must receive priority in processing order ahead of all other new gTLD applicants, including the IDN applicants that elect to participate in the prioritization draw.

⁶⁹ See Affirmation with Modification 15.4 in the SubPro PDP Final Report, pp.65-66:

<https://gnso.icann.org/sites/default/files/file/field-file-attach/final-report-newgld-subsequent-procedures-pdp-02feb21-en.pdf#page=65>

D1b Rationale for Final Recommendations:

Rationale for Final Recommendation 3.3: For the avoidance of doubt, at the time this recommendation was developed, it was envisaged that only existing IDN gTLDs delegated as a result of the 2012 round would be impacted, based on the calculation of RZ-LGR version 5.. This recommendation is complementary to [Final Recommendation 3.2](#), which seeks to address potential applications for allocatable variant labels of future gTLDs that will be delegated in the root zone.

Among the 1,265 existing gTLDs, only 35 Chinese gTLDs and 9 Arabic gTLDs have allocatable variant labels according to the calculation of the latest RZ-LGR version 5.⁷⁰ In order to support deliberations on the timing and mechanism by which those registry operators could apply for variant labels, the EPDP Team sent out a survey targeting the registry operators of those gTLDs. Among the 34 registry operators who were surveyed, 22 (64.7%) responded. The vast majority of respondents indicated interest in applying for allocatable variant labels of their gTLDs, but expressed a range of views in terms of the desired timeframe of applying for variant labels and factors that may affect their application decisions.⁷¹

In the survey results and during the EPDP Team deliberations, some support was expressed for a simplified, standalone process for existing registry operators to apply for allocatable variant labels of their IDN gTLDs before the next application round. The EPDP Team agreed that applications for variant labels of existing gTLDs will require evaluation to ensure the gTLD variant labels are introduced and managed in a safe and secure manner. Consequently, the EPDP Team examined the process flow of the New gTLD Program in order to understand the feasibility of a simplified, standalone process.⁷² See the process flow diagram in Annex H.

This process flow assumes that the next application round of the New gTLD Program will have similar application and evaluation elements as the 2012 round. It also anticipates new elements based on the recommendations from the SubPro PDP as well as a subset of draft recommendations from the EPDP-IDNs. Note that this diagram is a working product to support understanding of the impact of a subset of the EPDP Team's recommendations that were drafted at the time of the EPDP Team's deliberation of this charter question. It is not intended to be authoritative.

In examining this process flow, the EPDP Team observed that an application for a gTLD variant label must go through the same steps and stages as any applicant in the New gTLD Program. The EPDP Team also observed that a number of the elements in the New gTLD Program will require modification to accommodate gTLD variant label applications.

⁷⁰ For a full list of existing gTLDs that have allocatable variant labels, please see the spreadsheet here:

https://docs.google.com/spreadsheets/d/1nvk7e1Wk_aauP-YbYDukidnUb2GXeUO-4LiXe-qvw6g/edit?usp=sharing

⁷¹ See survey result details here: [https://mm.icann.org/pipermail/gnso-epdp-idn-](https://mm.icann.org/pipermail/gnso-epdp-idn-team/attachments/20220707/8091596c/ResultsofSurveytoArabicandChineseIDNgTLDRetryOperators-GoogleDocs-0001.pdf)

[team/attachments/20220707/8091596c/ResultsofSurveytoArabicandChineseIDNgTLDRetryOperators-GoogleDocs-0001.pdf](https://mm.icann.org/pipermail/gnso-epdp-idn-team/attachments/20220707/8091596c/ResultsofSurveytoArabicandChineseIDNgTLDRetryOperators-GoogleDocs-0001.pdf)

⁷² During the ICANN75 session in September 2022, the EPDP Team reviewed and discussed the process flow to understand which elements in the New gTLD Program will be impacted by variant implementation, how such elements may need to be modified to accommodate variant labels, and the level of effort for evaluating variant labels. See the session recording and process flow details here: <https://community.icann.org/x/GAJpD>

In light of those observations, the EPDP Team agreed that the most expedient and cost-effective path forward for registry operators to apply for variant labels of their existing gTLDs is through the next application round of the New gTLD Program. Therefore, no separate process should be developed for this purpose.

Rationale for Final Recommendation 3.4: The EPDP Team noted SubPro PDP’s recommendation that future applications of new gTLDs “must be assessed in rounds”⁷³. The EPDP Team agreed that for the next application round and each subsequent round where a primary gTLD string is sought with one or more of its allocatable variant label(s) at the same time, the applicant will only be required to submit one application covering these labels. In other words, the applicant should not submit multiple applications for the primary gTLD string and its allocatable variant label(s) in the same round. Submitting one application would allow for an efficient and streamlined process.

This recommendation does not preclude the circumstance where an applicant only applies for a primary gTLD string during an application round and does not wish to apply for its allocatable variant label(s), if any.

Rationale for Final Recommendation 3.25: The EPDP Team developed this recommendation in response to a question raised in Public Comment. The EPDP Team agreed that withdrawal of an applied-for variant label should be allowed after the application has been submitted, but adding a variant label to that submitted application is prohibited. The EPDP Team understood that SubPro PDP Recommendation 20.8 permits string changes for an applied-for .Brand TLD string that is placed in a contention set under specific circumstances and conditions.⁷⁴ As such, such modification should be allowed for an applied-for primary gTLD string and its allocatable variant label in a .Brand TLD application.

Rationale for Final Recommendation 3.5 and Implementation Guidance 3.6: As the delegation of gTLD variant labels at the root zone is unprecedented, the EPDP Team agreed that it will be important for applicants to justify in their application why they need the applied-for variant labels of the primary gTLD string. This will be achieved by responding to the application questions outlined in [Final Recommendation 3.5](#), which will be in addition to providing an explanation of the mission and purpose of the applied-for primary gTLD string. It is important to note that the applicant is expected to answer these questions for each and every applied-for variant label. These questions are intended to demonstrate that the applicant has carefully considered whether the applied-for variant labels are needed to achieve their stated objectives and to deter frivolous applications that may arise because of [Final Recommendation 3.11](#). In line with the conservatism principle, variant labels that are not deemed necessary by the evaluators, but are merely made possible for delegation due to the RZ-LGR calculation, should not be allocated or delegated.

⁷³ See Affirmation with Modification 3.1 in the SubPro PDP Final Report, p.20:

<https://gnso.icann.org/sites/default/files/file/field-file-attach/final-report-newgtld-subsequent-procedures-pdp-02feb21-en.pdf#page=20>

⁷⁴ See Recommendation 20.8 in the SubPro PDP Final Report, p.92:

<https://gnso.icann.org/sites/default/files/file/field-file-attach/final-report-newgtld-subsequent-procedures-pdp-02feb21-en.pdf#page=92>

The EPDP Team had extensive discussion about the evaluation elements set out in [Final Recommendation 3.5](#). The team recognized that after the gTLD variant labels are delegated and become operational, potential permutation issues may arise because of the many possible combinations of variant labels at both the top-level and the second-level, causing operational and management complexities that may impact registrars, resellers, and/or registrants. Therefore, 3.5.4 seeks to understand the applicant’s proposed approach to minimize such complexities from operational and management standpoints. By way of explanation, management is responsible for overall strategic decision-making and resource allocation, while operation executes the plans and processes necessary for day-to-day functioning.

The EPDP Team developed [Implementation Guidance 3.6](#) to clarify how the applicant’s responses to the elements established in [Final Recommendation 3.5](#) should be evaluated and consistently applied for each applied-for variant label. The EPDP Team agreed the generally understood “standard of reasonableness” would be the appropriate test to be applied and that the applied-for variant labels receiving a passing score (1 point) for each question would be eligible to proceed to the next stage of the application process. In the event that one or more of the applied-for variant labels fails the evaluation, this should not impact the evaluation outcome of the other applied-for variant labels in that application, or the applied-for primary gTLD string. The applied-for variant label(s) in the same application that receive a passing score for each question can still proceed to the next stage of the application process.

The EPDP Team agreed that the same requirements, as set out in [Final Recommendation 3.5](#) and [Implementation Guidance 3.6](#), will also apply to existing registry operators who wish to apply for allocatable variant label(s) of their existing gTLDs.

In summary, [Final Recommendation 3.5](#) and [Implementation Guidance 3.6](#) aim to strike a balance with [Final Recommendations 3.11, 3.12, and 8.1](#), which were perceived as “non-conservative” by some Public Comment respondents. These recommendations refer to charging the base application fee for an application that includes up to four (4) allocatable variant labels plus the primary gTLD string from a variant label set, as well as not setting a ceiling for the number of allocatable variant labels that can be delegated for any one primary gTLD string. EPDP Team agreed not to place arbitrary constraints that may discourage gTLD variant label applicants, but instead chose to enhance certain evaluation elements that are built into the application process, with the goal of supporting efficacy in the introduction of gTLD variant labels in a secure and stable manner.

[Rationale for Final Recommendation 3.7 and Implementation Guidance 3.8-3.9](#): The EPDP Team agreed that it is important that applicants are able to demonstrate their technical capability to operate and manage the applied-for primary gTLD string as well as the applied-for allocatable variant label(s) by answering relevant application questions. The EPDP Team agreed that the evaluation of the applicant’s capability to manage the variant label set should be closely tied to the overall evaluation of the applicant’s technical capability to operate the proposed primary gTLD and its variant label(s). The same requirement applies to existing registry operators who wish to apply for allocatable variant label(s) of their existing gTLDs.

The EPDP Team agreed that the evaluation of technical and operational capability should be based on measurable criteria to be determined during implementation. Such criteria may include, but not limited to, the performance of the Critical Functions with respect to second-

level registrations under the applied-for primary gTLD string and the applied-for allocatable variant label(s).⁷⁵

The EPDP Team recognized that the delegation of gTLD variant labels is unprecedented and there is uncertainty about how the variant label set will be managed and operated by the registry operator. Therefore, the EPDP Team recommends that within 15 months of the delegation of the first gTLD variant label and every 24 months thereafter ICANN org should conduct research in order to identify whether any additional criteria or tests should be used, as part of the application process, to evaluate the technical and operational capability of a future applicant for gTLD variant labels. ICANN org must provide public consultation opportunities on the scope and any proposed outputs of the research. For avoidance of doubt, any such additional criteria or test should not be used to evaluate the technical and operational capability of a registry operator that has already been managing a variant label set before such additional criteria or tests are published.

Rationale for Final Recommendation 3.10: The EPDP Team agreed with SubPro PDP's Affirmation with Modification 15.4 that the New gTLD Program should be self-sustaining without the need for funding from other sources and that the program should operate on a cost recovery basis with the goal of being revenue neutral.⁷⁶

The EPDP Team acknowledged that some future applications that contain variant label(s) may be more complicated to evaluate than other applications for a single gTLD. The EPDP Team also noted that while some variant label(s) may be intended as a commercial opportunity to explore a new market, some other variant label(s) may be intended for users to have a complete online experience, as those users may consider the variant label set as one single gTLD. The EPDP Team recognized that the cost recovery principle applies to the overall New gTLD Program, and the costs of running the program would be borne by all applicants collectively.

The EPDP Team suggested that ICANN org may want to take the aforementioned perspectives into account and consider how the application fee should be derived in order to maintain consistency with the cost recovery principle.

Rationale for Final Recommendations 3.11-3.14: The EPDP Team agreed that the application fee structure should strike a balance between providing financial incentives to encourage the introduction of gTLD variant labels that help build a multilingual Internet and limiting potential security and stability risks associated with the permutation of variant labels. Since the EPDP Team decided not to impose a ceiling value for the delegated top-level variant labels as per Final Recommendation 8.1, some members raised concerns that an applicant may apply for an excessive number of variant labels, which will likely cause increased complexity for the evaluation.

⁷⁵ The Critical Functions are: DNS Service, DNSSEC proper resolution, EPP, RDDS, and Data Escrow. See details in Section 6 of Specification 10 in the Base Registry Agreement:

<https://newgtlds.icann.org/sites/default/files/agreements/agreement-approved-31jul17-en.html#specification10>

⁷⁶ See Affirmation with Modification 15.4 in the SubPro PDP Final Report, pp.65-66:

<https://gnso.icann.org/sites/default/files/file/field-file-attach/final-report-newgtld-subsequent-procedures-pdp-02feb21-en.pdf#page=65>

As noted in the rationale for [Final Recommendation 8.1](#), only seven scripts integrated in the RZ-LGR have allocatable variant labels, namely Arabic, Bengali, Chinese, Greek, Latin, Myanmar, and Tamil. Except for Arabic, the language communities of the other six scripts have already limited the number of allocatable variant labels that can be applied for as gTLDs (i.e., one to four variant labels of the primary label are allocatable).⁷⁷ In other words, only the applications in the Arabic script could potentially include an exponentially high number of variant labels.

As such, the EPDP Team reached out to the Arabic Generation Panel (GP), seeking its guidance regarding a reasonable number of allocatable variant labels that should be delegated to adequately serve the Arabic script users in various regions around the world. By the time the Phase 1 Final Report was published, the Arabic GP had not reached a conclusion on the reasonable number for variant labels that should be allocatable for a gTLD in the Arabic Script.

In the absence of input from the Arabic GP, the EPDP Team supports a recommendation that a future gTLD applicant applying for a primary gTLD string and up to four (4) of the string's allocatable variant labels during an application round must incur the same base application fee as any other gTLD applicant who does not apply for variant labels in that round. The EPDP Team recommends this threshold number based on the known upper bound for allocatable variant labels permitted by the RZ-LGR for the scripts that have allocatable variant labels (with the exception of Arabic).

If the applied-for allocatable variant labels in an application submitted in any round exceed the threshold number of four (4), ICANN org should assess whether the costs associated with evaluating the additional labels warrant charging additional fees that they consider proportionate to any additional evaluation costs and consistent with the cost recovery principle.

Furthermore, the EPDP Team recommends that an application only for allocatable variant label(s) of a future delegated primary gTLD must incur a discounted base application fee as determined by ICANN org and considered to be proportionate to any costs associated with evaluating the application and consistent with the cost recovery principle. Since the primary gTLD is already delegated, there is a presumption that some evaluation elements for its allocatable variant label(s) may not necessarily apply. Under this situation, such an application should not incur the same base application fee, but it should not be free either. As such, a discount on the base application fee for such an application seems appropriate. Nevertheless, ICANN org has the discretion to establish what constitutes a discount.

During the EPDP Team discussion of fees for applications that only include allocatable variant labels, some members suggested that as long as the threshold number of four (4) allocatable variant labels of a primary gTLD string has not been exceeded, the applicant should not pay more application fees over and above the base application fee already paid by the applicant

⁷⁷ ICANN org staff checked all scripts in the RZ-LGR version 5, which was the version available when the EPDP Team deliberated on Recommendation 1.4, and those incorporated in the next version (i.e., RZ-LGR version 5) to see if there are mechanisms in place to reduce the number of allocatable variant labels. For the scripts with allocatable variant labels, ICANN org staff ran all existing gTLDs in those scripts through the RZ-LGR to see how many variant labels are created. The findings were presented during the EPDP Team meeting on 20 January 2022. See slides here: <https://community.icann.org/download/attachments/183992731/EPDP%20on%20IDNs%20-%20A5%20-%2020%20Jan%202022.pdf?version=1&modificationDate=1642693642936&api=v2>

when the primary gTLD string was initially applied for. The EPDP Team considered this proposal, but decided to recommend the discounted base application fee for any number of allocatable variant labels that are applied for separately from the application for the primary gTLD string.

The EPDP Team believes that its recommended approach should encourage applicants to optimize their business interests to introduce as many gTLD variant labels as they need in an expeditious manner, while preventing the scenario where an excessive number of variant labels are being applied for. In addition, the EPDP Team noted that in the 2012 round, the same base application fee applied to all types of applications, including those that had different evaluation elements or underwent extended evaluation (e.g., Geographic Name TLD applications, IDN applications that included the evaluation of a large number of IDN tables).

Furthermore, [Final Recommendation 3.14](#) was specifically developed for the registry operators of existing IDN gTLDs delegated as a result of the 2012 round. As noted in the rationale for [Final Recommendation 3.3](#), among the 1,265 existing gTLDs from the 2012 round, only 35 Chinese gTLDs and 9 Arabic gTLDs have allocatable variant labels according to the RZ-LGR calculation. The majority of those registry operators who responded to the EPDP Team's survey expressed interest in applying for variant labels of their existing IDN gTLDs. In addition, 24 out of the 26 Chinese gTLD registry operators and 3 out of 9 Arabic gTLD registry operators self-identified "variants" for their applied-for IDN gTLDs during the 2012 round.

Given that those existing IDN gTLD registry operators already paid the US\$185,000 base application fee in the 2012 round and they were unable to apply for variant labels at that time, the EPDP Team recommends, as a one-time exception, a waiver of the base application fee for an existing registry operator from the 2012 round who applies for up to four (4) variant labels of its existing IDN gTLD during the immediate next application round. This is to help compensate for the lapsed time in which variant labels have been unavailable to those registry operators despite their business interests or needs, as well as the interests or needs of the intended language communities.

If an existing registry operator from the 2012 round applies for variant label(s) not during the immediate next application round but during a subsequent round, the waiver will not apply. [Final Recommendation 3.13](#) applies to existing registry operators from the 2012 round, meaning that an application for allocatable variant labels that is submitted in any application round subsequent to the immediate next application round must incur a discounted base application fee as any other future registry operators who apply only for allocatable variant labels in that round. Furthermore, [Final Recommendation 3.12](#) also applies to existing registry operators from the 2012 round, meaning that an application for more than four (4) allocatable variant labels of an existing IDN gTLD in an application may incur additional fees.

Rationale for Final Recommendation 3.15: This recommendation was specifically developed for the registry operators of existing IDN gTLDs delegated as a result of the 2012 round. The EPDP Team affirmed SubPro PDP Recommendation 19.3, which seeks to ensure that IDN gTLD

applications are prioritized in the processing order in the next application round.⁷⁸ Going one step further, the EPDP Team recommends granting, as a one-time exception for the immediate next application round, priority for the processing of applications for allocatable variant labels submitted by existing IDN gTLD registry operators from the 2012 round, ahead of all other applications including the IDN applications that elect to participate in the prioritization draw.

In practice, this means that for the immediate next application round, the variant label applications from existing IDN gTLD registry operators from the 2012 round must be assigned priority ahead of any other application, including IDN applications in each group of applications that are being processed in accordance with the formula set forth in SubPro PDP Recommendation 19.3. In other words, the variant label applications from existing IDN gTLD registry operators must be processed first among the applications that are being prioritized.

As mentioned in the rationale for Final Recommendation 3.3, the majority of the registry operators who responded to the survey expressed interest in applying for variant labels of their existing IDN gTLDs. In addition, 24 out of the 26 Chinese gTLD registry operators and 3 out of 9 Arabic gTLD registry operators who were surveyed self-identified “variants” for their applied-for IDN gTLDs during the 2012 round.⁷⁹

The EPDP Team considers it fair and reasonable to prioritize variant applications from existing IDN gTLD registry operators, as a one-time exception for the immediate next application round. The IDN gTLD applicants in 2012 were unable to apply for their variant labels, and their language communities have been subsequently disadvantaged for more than a decade. It will also help ensure that the applied-for allocatable variant labels of existing IDN gTLDs that successfully pass the evaluation can be delegated as soon as possible in order to fulfill the business interests or needs of those registry operators, as well as the interests or needs of the intended language communities. For example, some EPDP Team members stressed the importance and urgency of delegating variant labels of Chinese gTLDs in order to facilitate access to Chinese domain names in the Greater Chinese language speaking region that includes billions of users.

In addition, the EPDP Team believes that the potential number of variant applications from existing IDN gTLD registry operators will be limited based on the aforementioned survey.

D1b Public Comment Review:

Wording Change: Final Recommendations 3.3-3.5, 3.7, 3.10-3.13 incorporated the suggested wording change raised in Public Comment, as explained in the Public Comment Review section for Final Recommendations 1.1-2.1:

- Use “existing” when referring to all of the gTLDs that have been delegated in the root zone.

⁷⁸ See Recommendation 19.3 in the SubPro PDP Final Report, pp.87-88:

<https://gnso.icann.org/sites/default/files/file/field-file-attach/final-report-newgtld-subsequent-procedures-pdp-02feb21-en.pdf#page=87>

⁷⁹ The EPDP Team reviewed data related to the self-identified “variants” during its meeting on 17 February 2022. See details in the presentation slides here:

<https://community.icann.org/download/attachments/183992744/EPDP%20Team%20Meeting%20%2324%20Slides%20-%20D1b.pdf?version=2&modificationDate=1645113005000&api=v2>

- Refrain from mentioning “2012 round” in the recommendation language when referring to the existing gTLDs, as this may be perceived as limiting and can potentially cause misinterpretation.
- Remove the mention of “IDN” in order to future-proof potential updates to the RZ-LGR, in the event that allocatable variant labels are created from ASCII code points.
- Add clarification in the rationale of Final Recommendation 3.3 that at the time the recommendation was developed, it was envisaged that only existing IDN gTLDs delegated as a result of the 2012 round would be impacted, based on the RZ-LGR version 5 calculation.

Final Recommendation 3.4: The EPDP Team accepted a suggestion raised in Public Comment to further clarify that applicants should not submit multiple applications for allocatable labels from the same variant label set in the same round.

Final Recommendation 3.25: A question was raised in Public Comment, which seeks clarity on EPDP Team’s stance on allowing applicants to add, withdraw, or modify applied-for gTLD variant labels through the application change request process. The EPDP Team developed this new recommendation in response to this question.

Final Recommendation 3.5 and Implementation Guidance 3.6: Based on input received from Public Comment, the EPDP Team agreed to clarify the intent of these recommendations and explain how applicants’ responses regarding the “need” for variant labels are expected to be evaluated and scored. In addition, following the discussion of Public Comments received for Final Recommendations 3.11, 3.12, and 8.1, the EPDP Team enhanced the evaluation elements of gTLD variant label applications, as set out in these two recommendations, to align with the conservatism principle and to deter frivolous applications.

Implementation Guidance 3.8: The EPDP Team agreed with an observation shared in Public Comment, and removed from the rationale the sentence regarding technical evaluation questions “should not differ significantly from the application questions of the 2012 round”.

Implementation Guidance 3.9: The EPDP Team accepted several suggestions raised in Public Comment to:

- set the expected time frame for ICANN org to conduct the proposed research;
- replace the original word “standards” with “criteria”, as it may be premature to expect that standards for managing a variant label set can be identified at an early stage;
- provide public consultation opportunity for the scope and the outputs of the research;
- clarify that any additional criteria or tests resulting from the research will only be applied prospectively, not retroactively.

These amendments seek to enhance this implementation guidance to align with the conservatism principle, following the EPDP Team’s discussion of Public Comments received for Final Recommendations 3.11, 3.12, and 8.1.

Final Recommendations 3.11-3.12: The EPDP Team noted that these recommendations, as well as the closely related Final Recommendation 8.1 received strong support from many commenters. The EPDP Team had extensive discussion about the concerns raised by some commenters regarding these recommendations, in conjunction with Final Recommendation 8.1.

They understood that those commenters were concerned about what they perceived to be a less than conservative approach of charging the base application fee that includes up to four (4) allocatable variant labels plus the primary gTLD string from a variant label set, as well as not setting a ceiling for the number of allocatable variant labels that can be delegated for any one primary gTLD string. Notwithstanding, there was overwhelming support from the EPDP Team for not changing the threshold number and not setting an arbitrary ceiling. The Team believes that the more arbitrary constraints are placed on gTLD variant label applications, the more difficult it would be for encouraging the introduction of gTLD variant labels and promoting IDN registrations that help build a multilingual Internet. The EPDP Team agreed to enhance [Final Recommendation 3.5](#) and [Implementation Guidance 3.6](#) and [3.9](#) regarding the evaluation of gTLD variant label applications in order to align with the conservatism principle.

Final Recommendation 3.13: One Public Comment respondent raised the concern regarding the terms “discounted” and “discount”. The EPDP Team agreed that ICANN org has the discretion to establish what “discount” means and determine the actual cost reduction based on further analysis. Hence, there was no substantive change to the recommendation.

Final Recommendations 3.14-3.15: The EPDP Team agreed not to apply the aforementioned wording change to these recommendations, as they were specifically developed to include one-time exceptions for the registry operators that manage Chinese and Arabic gTLDs delegated as a result of the 2012 round. The EPDP Team noted concern from one commenter regarding these exceptions, but agreed that such a concern may be overstated due to a misunderstanding of the intent of the recommendations, and the number of existing IDN gTLD registry operators that can benefit from those exceptions is limited. In [Final Recommendation 3.14](#), EPDP Team took into account a suggestion received from Public Comment and provided a numbered list, replacing the original bullet list, to enhance specificity.

B5 Charter Question:

Do restrictions that apply to a TLD (e.g., community TLDs, dot brand TLDs) also apply to its variants? Are these labels equally treated as different versions of the same string, or completely independent strings not bound by the same restrictions?

B5 Final Recommendations:

Final Recommendation 3.16: An applied-for allocatable variant label must be subject to the same application requirements and evaluation criteria as the associated primary gTLD string. Specifically, the same documentation requirements apply to both the primary gTLD string and its applied-for allocatable variant label(s). With respect to the three non-standard application types of gTLDs as identified by the SubPro PDP, this means that:

3.16.1 An applicant for a **Community-based TLD string and its allocatable variant label(s)** is required to submit a written endorsement of its applied-for primary gTLD

string and applied-for allocatable variant label(s) from established institution(s) representing the community that the applicant has named.⁸⁰

3.16.2 An applicant for a **Geographic Name TLD string and its allocatable variant label(s)** is required to submit documentation of support or non-objection to its applied-for primary gTLD string and applied-for allocatable variant label(s) from relevant governments or public authorities.

3.16.3 An applicant for a **.Brand TLD string and its allocatable variant label(s)** is required to submit proof that its applied-for primary gTLD string and applied-for allocatable variant label(s) are identical to registered trademarks owned and used by the registry operator or its affiliate.⁸¹

B5 Rationale for Final Recommendations:

Rationale for Final Recommendation 3.16: The EPDP Team affirmed that the same application requirements and evaluation criteria apply to both the primary gTLD string and its applied-for allocatable variant label(s).

The EPDP Team discussed the three categories of gTLDs that have non-standard application types as identified by SubPro PDP, and those are: 1) Community-based TLD, 2) Geographic Name TLD, and 3) .Brand TLD.

With respect to applications for allocatable variant labels of Community-based TLD strings and Geographic Name TLD strings, the EPDP Team emphasized that the required documents must provide, respectively, explicit endorsement or support/non-objection to all of the applied-for allocatable variant labels.

With respect to applications for allocatable variant labels of .Brand TLD strings, the EPDP Team stressed that each of the applied-for allocatable variant labels must be an exact match to and supported by a registered trademark of the registry operator or its affiliate. The EPDP Team noted that under trademark law, the rights are attached to one, distinct mark limited to an exact match; the concept of variants does not exist in trademark law. Even though an allocatable variant label of a primary .Brand TLD is withheld for possible allocation only to that .Brand TLD's registry operator or its affiliate based on the "same entity" principle, it cannot be delegated as a .Brand TLD without meeting the same requirements as the primary gTLD. Reaffirming [Final Recommendation 7.14](#), the EPDP Team agreed that an allocated or delegated variant label of a .Brand TLD, as a result of the application being approved, must be .Brand TLDs as well, not a different type of TLD.

⁸⁰ Based on the 2012 Applicant Guidebook, factors that may be considered in making the determination of an "established institution" include, but are not limited to: Level of global recognition of the institution; length of time the institution has been in existence; and public historical evidence of its existence, such as the presence of a formal charter or national or international registration, or validation by a government, inter-governmental organization, or treaty. The institution must not have been established solely in conjunction with the gTLD application process.

⁸¹ The SubPro PDP identified only three categories of gTLDs that have non-standard application types and affirmed that the same application requirements and evaluation criteria for these application types, as set out in the 2012 Applicant Guidebook, apply in future rounds. See Recommendation 4.1 in the SubPro PDP Final Report, pp.24-27: <https://gnso.icann.org/sites/default/files/file/field-file-attach/final-report-newgld-subsequent-procedures-pdp-02feb21-en.pdf#page=24>

B5 Public Comment Review:

Final Recommendation 3.16: One public comment raised concerns regarding the unclear definition of “established institution” in the recommendation and suggested deleting this term. The EPDP Team affirmed that this term originated from the 2012 Applicant Guidebook and was reaffirmed by the SubPro PDP Final Report. Footnote 80 was included to provide reference to the “established institution”. In addition, the EPDP Team also provided a numbered list, replacing the original bullet list, to enhance specificity.

A7 Charter Question:

The SubPro PDP recommends that single character gTLDs may be allowed for limited script/language combinations where a character is an ideograph (or ideogram) and do not introduce confusion risks that rise above commonplace similarities, consistent with SAC052 and Joint ccNSO-GNSO IDN Workgroup (JIG) report.⁸²

What mechanism or criteria should be used to identify the scripts/languages appropriate for single-character TLDs? Once those scripts/languages are identified, what mechanism or criteria should be used to identify a specific list of allowable characters which can be used as a single-character TLD within such scripts/languages? Should any specific implementation guidance be provided? Furthermore, should the relevant GP tag these code points in the RZ-LGR for a consistent analysis and to ease their identification and algorithmic calculation?⁸³

A7 Final Recommendations:

Final Recommendation 3.17: The EPDP Team affirmed the Recommendation 25.4 in the SubPro PDP Final Report that single-character gTLDs may only be allowed for limited scripts and languages where a character is an ideograph. At the time of the EPDP Team’s deliberations, the only script that meets the criteria is the Han script, which is used in the Chinese, Japanese, and Korean languages. Nevertheless, applications for single-character gTLDs that are ideographs must not be accepted until relevant guidelines from the Chinese, Japanese, and Korean Generation Panels are developed, finalized after Public Comment, and implemented in the New gTLD Program. In the event that the Generation Panels determine such additional guidelines beyond the analysis already provided in the RZ-LGR unnecessary, applications for single-character gTLDs in the Han script shall be accepted.

⁸² See Recommendation 25.4 in the SubPro PDP Final Report, p.115: <https://gnso.icann.org/sites/default/files/file/field-file-attach/final-report-newgtld-subsequent-procedures-pdp-02feb21-en.pdf#page=115>; Recommendation 1 in SAC052, p.8: <https://www.icann.org/en/system/files/files/sac-052-en.pdf#page=8>; the SubPro PDP does not believe it has the relevant expertise to make this determination and would welcome the identification of the limited set of scripts and languages and potentially a specific list of allowable single-characters (e.g., during implementation), which will substantially increase the predictability of what will likely still remain a case-by-case, manual process. See Rationale for Recommendation 25.4 in the SubPro PDP Final Report, pp.116-117: <https://gnso.icann.org/sites/default/files/file/field-file-attach/final-report-newgtld-subsequent-procedures-pdp-02feb21-en.pdf#page=116>

⁸³ See Annex B of the Recommendations for the Technical Utilization of the RZ-LGR, p.13: <https://www.icann.org/en/system/files/files/rz-lgr-technical-utilization-recs-07oct19-en.pdf#page=13>

A7 Rationale for Final Recommendations:

Rationale for Final Recommendation 3.17: The EPDP Team affirmed Recommendation 25.4 in the SubPro PDP Final Report that single-character TLDs may be allowed for ideographic script and language combinations.⁸⁴ At the time of the EPDP Team’s discussion, the Han script is the only ideographic script included in the RZ-LGR, and Chinese, Japanese, and Korean are the only languages incorporating the Han script.⁸⁵ Therefore, the EPDP Team recommends that the Han script and the Chinese, Japanese, and Korean languages are appropriate for single-character gTLDs.

The idea of developing a mechanism or criteria to identify allowable characters for single-character IDN TLDs originated from SAC052, which focuses on the delegation of single-character IDN TLDs.⁸⁶ It was developed in response to the ICANN Board resolution passed on 25 August 2011.⁸⁷ The Board resolution notes that technical and policy considerations must be addressed prior to delegation of any single-character TLDs.

SAC052 suggests that if a script is allowed for single-character TLDs, a distinct and explicit specification of which subset of the script is available for single-character TLDs should be required prior to the acceptance of a single-character TLD application. This suggestion was developed due to SSAC finding that single-character TLDs are more likely to cause user confusion than TLDs with more than one character.

The EPDP charter asks the EPDP Team to explore mechanisms or criteria to identify allowable characters for single-character TLDs. This question stems from the rationale of the SubPro PDP Recommendation 25.4, noting that the identification of a specific list of allowable single-character gTLDs will substantially increase the predictability of evaluating single-character gTLD applications in the future.⁸⁸

However, the EPDP Team recognized that it does not possess the linguistic expertise to effectively deliberate on this topic. Since the EPDP Team identified that single-character TLDs

⁸⁴ See Recommendation 25.4 in the SubPro PDP Final Report, p.115: <https://gnso.icann.org/sites/default/files/file/field-file-attach/final-report-newgtld-subsequent-procedures-pdp-02feb21-en.pdf#page=115>

⁸⁵ Concerning the term ideogram (and related ideograph), Unicode uses it to refer to the Chinese, Japanese and Korean (CJK) repertoire: <https://www.unicode.org/versions/Unicode14.0.0/ch18.pdf> (page 728): “The term ‘Han ideographic characters’ is used within the Unicode Standard as a common term traditionally used in Western texts, although ‘sinogram’ is preferred by professional linguists. Taken literally, the word ‘ideograph’ applies only to some of the ancient original character forms, which indeed arose as ideographic depictions. The vast majority of Han characters were developed later via composition, borrowing, and other non-ideographic principles, but the term ‘Han ideographs’ remains in English usage as a conventional cover term for the script as a whole.” Using this terminology, the Han script is the only ideographic script included in the RZ-LGR; see <https://www.icann.org/sites/default/files/lgr/lgr-4-overview-05nov20-en.pdf>, Section 7.2 (the table describes the repertoire per script).

⁸⁶ SAC052: <https://www.icann.org/en/system/files/files/sac-052-en.pdf>

⁸⁷ 25 August 2011 Board resolution: <https://www.icann.org/resources/board-material/resolutions-2011-08-25-en#5>

⁸⁸ See Rationale for Recommendation 25.4 in the SubPro PDP Final Report, pp.116-117: <https://gnso.icann.org/sites/default/files/file/field-file-attach/final-report-newgtld-subsequent-procedures-pdp-02feb21-en.pdf#page=116>

may be allowed for the Han script, it agreed that Chinese, Japanese, and Korean Generation Panels (CJK GPs) are best-positioned to consider this question.

The EPDP Team consulted with chairs of the CJK GPs about the feasibility of developing such a mechanism or criteria.⁸⁹ The CJK GP chairs stressed that the consideration of confusion risks of single-character TLDs in the context of new gTLD application evaluation is outside the scope and expertise of GPs. Nevertheless, they agreed that it may be feasible to develop a prohibitive list of Han characters based on narrowly defined technical criteria, such as characters that are not ideographs and characters that are symbols, which may cause security, stability, and confusion risks that rise above commonplace similarities.

As a result of this consultation, the EPDP Team requested the CJK GPs to look into the possibility of developing guidelines for a prohibitive list of Han characters that will not be allowed as single-character TLDs, as opposed to an inclusive list of characters that could be allowed as single-character TLDs. The GPs are expected to consider the recommendations from SAC052 when conducting this work.

The EPDP Team understood that CJK GPs may conduct this work based on their existing process and procedures, including coordination with local communities and inclusion of additional experts to their panels, as needed. The final set of guidelines for a prohibitive list of Han characters to be developed by the GPs should be subject to the Public Comment process for broader community input.

The EPDP Team agreed that the CJK GPs' guidelines on single-character TLDs must be implemented in the New gTLD Program for the evaluation of future applications for single-character new gTLDs in the Han script. The specificity of implementation depends on the final set of guidelines after considering public comments received.

Notwithstanding the EPDP [Final Recommendation 3.17](#) and SubPro PDP Recommendation 25.4 which permit single-character gTLDs in the Han script, the EPDP Team recommends that applications for single-character gTLDs not be accepted until relevant guidelines from the Chinese, Japanese, and Korean Generation Panels have been developed, finalized after Public Comment, and are implemented in the New gTLD Program. This conservatism is consistent with the aforementioned ICANN Board resolution, SSAC advice, and SubPro PDP recommendation. Nevertheless, In the event that the Generation Panels determine such additional guidelines beyond the analysis already provided in the RZ-LGR unnecessary, applications for single-character gTLDs in the Han script shall be accepted in the next application round and subsequent rounds.

⁸⁹ In May 2022, the EPDP Team sent an outreach letter that includes a list of specific questions regarding single-character TLDs. Consequently, the EPDP Team discussed the responses received: <https://community.icann.org/x/gAB1Cw>. In September 2022, the leadership met with the CJK GP chairs during the ICANN75 Kuala Lumpur meeting to seek further input on this topic. During that meeting, the CJK GP chairs expressed agreement with conducting the additional work to look into the possibility of developing guidelines and/or a prohibitive list of Han characters that will not be allowed as single-character TLDs.

A7 Public Comment Review:

Final Recommendation 3.17: Several commenters supported this recommendation as written.

E5 Charter Question:

The WG and the SubPro IRT to coordinate and consider the following questions in order to develop a consistent solution: should the reserved strings ineligible for delegation for existing and future gTLDs be updated to include any possible variant labels? Consider this question by taking into account the data to be collected in the “Data and Metric Requirements” section of this charter.

E5 Final Recommendations:

Final Recommendation 3.18: The New gTLD Program Reserved Names list must not be expanded to include variant labels.

Final Recommendation 3.19: No application for a variant label of a New gTLD Program Reserved Name is allowed.

Final Recommendation 3.20: The list of Strings Ineligible for Delegation must not be expanded to include variant labels.

Final Recommendation 3.21: Only the protected organizations on the list of Strings Ineligible for Delegation are allowed to apply for the allocatable variant label(s) of their protected string(s) at the top-level. Consistent with [Final Recommendation 3.1](#), an application for an allocatable variant label of a protected string cannot precede an application for the protected string, which serves as the primary label for generating the variant label.

E5 Rationale for Final Recommendations:

Rationale for Final Recommendation 3.18-3.19: The EPDP Team understands that the purpose of the New gTLD Program Reserved Names (“Reserved Names”) list is to maintain the exclusive rights to the names of ICANN, its bodies, or essential related functions of ICANN and IANA.⁹⁰ The EPDP Team affirmed SubPro PDP’s recommendation to include “PTI” in the Reserved Names list.⁹¹ The EPDP Team also understands that in future new gTLD application rounds, an applied-for gTLD string and its allocatable and blocked variant label(s) will be compared against the

⁹⁰ See section 2.2.1.2.1 of the 2012 Applicant Guidebook.

⁹¹ See Recommendation 21.4 in the SubPro PDP Final Report, p.95:

<https://gnso.icann.org/sites/default/files/file/field-file-attach/final-report-newgtd-subsequent-procedures-pdp-02feb21-en.pdf#page=95>

Reserved Names and their allocatable and blocked variant labels in the String Similarity Review process in accordance with Final Recommendation 4.1-4.3.⁹²

In order to consider whether the Reserved Names list should be expanded to include variant labels, the EPDP Team reviewed the variant labels of the Reserved Names as calculated by the RZ-LGR version 4, which was the version available during the EPDP Team’s deliberation of this charter question.⁹³ All of the Reserved Names, except for the IDN “test” strings, are ASCII strings and only have blocked variant labels.⁹⁴

The EPDP Team agreed that there is no need to expand the Reserved Names list to include variant labels. The Reserved Names are reserved for a specific purpose, and the trend over time has been to limit the number of Reserved Names in the list. To the extent there is an interest to expand the list, there is an existing process to follow.

In addition, per Final Recommendations 4.1-4.3, the modified String Similarity Review will include the visual check for every applied-for gTLD string and its allocatable and blocked variant label(s) against all the Reserved Names and their allocatable and blocked variant labels. An applied-for gTLD string that is same or similar to a Reserved Name or a variant label of a Reserved Name will not pass the review. Therefore, the EPDP Team agreed that the Reserved Names list will stay as is and no variant labels will be added.

Furthermore, the EPDP Team converged on the idea that no application for a variant label of a Reserved Name is allowed. This recommendation seeks to enhance the purpose of Reserved Names by ensuring that their variant labels are also inaccessible without the need to add them to the Reserved Names list. From an implementation perspective, the EPDP Team envisioned that if an applicant enters an applied-for gTLD string that is an exact match of a variant label of a Reserved Name, the application system will recognize the label and will reject the application.

Rationale for Final Recommendation 3.20: The EPDP Team understands that the purpose of the Strings Ineligible for Delegation is to provide special protections at the top-level and second-level for the names and acronyms of intergovernmental organizations (IGOs) and international non-governmental organizations (INGOs), which receive protections under treaties and statutes across multiple jurisdictions.⁹⁵ Those organizations specifically include the Red Cross/Red Crescent Movement (RCRC) and the International Olympic Committee (IOC).

⁹² In the context of recommendations in this Phase 1 Final Report, a “blocked” label refers to either: 1) a label within the same script that is deemed valid as a top-level domain by the RZ-LGR but unavailable for allocation or delegation; or 2) a mixed-script blocked label permitted by the RZ-LGR as an exception (i.e., only Japanese has such an exception). To be clear, the “blocked” variant labels in this Phase 1 Final Report do not include the labels created by mixing different scripts. Such mixed-script labels are not eligible to be top-level domains with the exception of Japanese.

⁹³ ICANN org staff calculated the variant labels of New gTLD Program Reserved Names by running them through the RZ-LGR version 4, which was the latest available version during the time of this charter question deliberation: https://docs.google.com/spreadsheets/d/11OkBT_1-kABdUgy7kbrf9bd8PHFPtP9A/edit?usp=sharing&oid=101698682360672018983&rtpof=true&sd=true. The RZ-LGR version 5 was published in May 2022: <https://www.icann.org/resources/pages/root-zone-lgr-2015-06-21-en>

⁹⁴ See the IDN “test” strings here: <https://www.iana.org/domains/reserved>

⁹⁵ The entity that possesses the string ineligible for delegation is referred to as the “protected organization”, per Final Report on the Protection of IGO and INGO Identifiers in All gTLDs Policy Development Process: https://gnso.icann.org/sites/default/files/filefield_42639/igo-ingo-final-10nov13-en.pdf

The EPDP Team learned that the PDP on the Protection of IGO and INGO Identifiers in All gTLDs explored in detail the issues related to whether those international organizations should receive special protection for their names.⁹⁶ As an outcome of that PDP, a specific and finite list of identifiers will be included in the future version of the Applicant Guidebook (AGB) as Strings Ineligible for Delegation. This is to grant preventative protections to the identifiers limited to exact match and on the basis of internationally recognized treaties. The EPDP Team also learned that to the extent that there is an interest from those protected organizations to modify or expand the list, such as adding variant labels, they can follow a specific process to do so.

With this context, the EPDP Team agreed that the list of Strings Ineligible for Delegation will stay as is and no variant labels will be added. The outcome of the PDP on the Protection of IGO and INGO Identifiers in All gTLDs, which took years to complete, should be respected and not be modified. Adding variant labels to the list could be interpreted as an extension of rights for the protected strings beyond those expressly identified in the relevant treaties.

Rationale for Final Recommendation 3.21: The EPDP Team agreed that no application for a variant label of a String Ineligible for Delegation will be allowed. However, the EPDP Team learned that there is an exception procedure designed to allow the protected organizations to apply for their respective strings in the list of Strings Ineligible for Delegation.⁹⁷

The EPDP Team recognized that the likelihood of an unrelated entity applying for a variant label of a protected string is small and there are other measures in the New gTLD Program to deter such applications (e.g., GAC Early Warning, GAC Advice, Objection Processes). However, this recommendation is intended to ensure that the variant labels are unavailable to other applicants rather than adding variant labels to the list of Strings Ineligible for Delegation.

The EPDP team was concerned that adding variant labels to the list of Strings Ineligible for Delegation could be interpreted by some as an expansion of the rights afforded to those strings on the basis of internationally recognized treaties. The EPDP Team stresses that preventing applications for variant labels of the Strings Ineligible for Delegation is expressly not an expansion of rights for those protected strings.

Consistent with Final Recommendation 3.1, the EPDP Team agreed that applying for the allocatable variant label of a protected string would only be possible if the protected organization had already applied for, or will be applying for at the same time, its protected string on the list of Strings Ineligible for Delegation.

The EPDP Team observed that the exception procedure mentioned above has yet to be developed. Hence, it is suggested, for consideration during the implementation of the final recommendations from the PDP on the Protection of IGO and INGO Identifiers in All gTLDs, that

⁹⁶ The PDP on the Protection of IGO and INGO Identifiers in All gTLDs concluded in November 2013. Learn more: <https://gnso.icann.org/en/group-activities/active/igo-ingo>

⁹⁷ See the Final Report on the Protections for the Protection of IGO and INGO Identifiers in All gTLDs Policy Development Process here: https://gnso.icann.org/sites/default/files/filefield_42639/igo-ingo-final-10nov13-en.pdf#page=10

a protected organization also uses the exception procedure when applying for the allocatable variant label(s) of their protected string(s).

E5 Public Comment Review:

Final Recommendations 3.18-3.19: The EPDP Team accepted a suggestion raised in Public Comment to revise the mention of “The Reserved Names list” to “The New gTLD Program Reserved Names list”. This amendment is to avoid confusion with “Registry Reserved Names”.

Final recommendations 3.20-3.21: Several commenters supported these recommendations as written.

A3 Charter Question:

SubPro PDP recommends that ICANN establish a mechanism that allows specific parties to challenge or appeal certain types of actions or inactions that appear to be inconsistent with the Applicant Guidebook.⁹⁸ SubPro PDP recommends that such a limited challenge/appeal mechanism applies to several types of evaluations and formal objections decisions, including the DNS Stability aspect of evaluation/challenge procedures. Previously, both the SSAC and TSG also recommended a challenge process for resolving disagreement with the RZ-LGR calculation on certain strings.⁹⁹

If an applied-for TLD label, whose script is supported by the RZ-LGR, is determined to be “invalid”, is there a reason NOT to use the evaluation challenge processes recommended by SubPro? If so, rationale must be clearly stated. If SubPro’s recommendation on the evaluation challenge process should be used, what are the criteria for filing such a challenge? Should any additional specific implementation guidance be provided, especially pertaining to the challenge to the LGR calculation as it can have a profound, decimating impact on the use of RZ-LGR?¹⁰⁰

A3 Final Recommendations:

Final Recommendation 3.22: Only an applied-for gTLD string that conforms to the mandatory string requirements, including IDNA 2008 for IDN strings, as well as the RZ-LGR, can be submitted through the new gTLD application submission system.

⁹⁸ See Recommendation 32.1 in the SubPro PDP Final Report, pp.154-155:

<https://gnso.icann.org/sites/default/files/file/field-file-attach/final-report-newgtd-subsequent-procedures-pdp-02feb21-en.pdf#page=154>

⁹⁹ Disagreement with the LGR calculator may arise due to circumstances including but not limited to: an invalid label due to choice of “letter” not included in the repertoire, albeit being IDNA2008 protocol-valid; an invalid label due to a contextual or whole label evaluation rule imposed by either integration or generation panels’ variant; labels differ because of different assumptions. SAC060 proposed a straw man process to resolve disputes to the RZ-LGR results. The TSG recommended several technical inputs be considered when developing the resolution mechanism. See Recommendation 2, SAC060, p.9: <https://www.icann.org/en/system/files/files/sac-060-en.pdf#page=9>; see Recommendation 4 in the TSG Report, pp.6-7: <https://www.icann.org/en/system/files/files/rz-lgr-technical-utilization-recs-07oct19-en.pdf#page=6>

¹⁰⁰ Any changes in RZ-LGR brought about by a process outside the LGR Procedure would invalidate the RZ-LGR and thus the definition of the TLD variant labels, as stated in the LGR Procedure. TSG suggests how to address such a challenge by remaining within the LGR Procedure.

Where the initial algorithmic check deems an applied-for gTLD string as “invalid” or “blocked” (where the applied-for string is a variant label), such application for a non-conforming string may be accepted but the applicant must be warned of its potential disqualification.

If the DNS Stability Panel (DSP) subsequently confirms the applied-for string as “invalid” or “blocked” per the RZ-LGR and disqualifies the application for the non-conforming string, the applicant may invoke a limited challenge mechanism for DNS Stability Review to seek a reassessment of the disqualification.

However, the applicant’s ground to challenge is limited to a belief that its applied-for gTLD string is valid and allocatable as per the RZ-LGR and that the disqualification by the DSP was due to an incorrect assessment of the technical implementation of the RZ-LGR.

Implementation Guidance 3.23: The new gTLD application submission system should issue a disqualification warning to the applicant, whose applied-for string conforms to the mandatory string requirement, when the initial algorithmic check finds the following: (i) the applied-for gTLD string is deemed “invalid”; and/or (ii) the applied-for variant label is deemed “invalid” or “blocked”. This warning recognizes the unlikely, but possible, situation that the RZ-LGR was programmed or incorporated into the application submission system incorrectly, and allows an opportunity for correction.

Final Recommendation 3.24: An applied-for gTLD string that has been accepted through the new gTLD submission system and correctly assessed by the DNS Stability Panel as “invalid” or “blocked” (where the applied-for string is a variant label) is disqualified unless and until such a string is deemed valid and allocatable in a future version of the RZ-LGR, if any.

A3 Rationale for Final Recommendations:

Rationale for Final Recommendation 3.22: The EPDP Team developed this recommendation based on assumptions including the following:

- 1) there will be an initial algorithmic check, which incorporates the RZ-LGR, in the new gTLD application submission system to check the validity of an applied-for gTLD string and disposition value where the applied-for string is a variant label;
- 2) applied-for gTLD strings that do not conform to mandatory string requirements, including IDNA 2008 for IDN strings, will not be accepted;
- 3) applied-for gTLD strings that conform to mandatory string requirements but are deemed by the initial algorithmic check as “invalid” or “blocked” (as the calculated disposition value where the applied-for string is a variant label) are allowed to be submitted for evaluation;
- 4) the DNS Stability Panel (DSP) will perform a manual review of all applied-for gTLD strings to ensure that the technical implementation of the RZ-LGR is done correctly in the initial algorithmic check; and

- 5) the DSP’s manual review is authoritative and its evaluation decision of an applied-for gTLD string being "invalid" or “blocked” will result in disqualification of the application.¹⁰¹

The EPDP Team agreed that the applicant will be allowed to challenge the DSP’s evaluation decision, but only on the grounds that the applicant believes the DSP has an incorrect assessment of the technical implementation of the RZ-LGR in the initial algorithmic check. Under such circumstances, a limited challenge mechanism for DNS Stability Review is considered fit for purpose.¹⁰²

Rationale for Implementation Guidance 3.23: The EPDP Team agreed that the RZ-LGR is the authoritative source for the validation of all gTLDs as well as the calculation of their variant labels and their respective disposition values (ie., allocatable or blocked). However, the EPDP Team recognized that there could be human error in the technical implementation of the RZ-LGR in the initial algorithmic check component of the new gTLD application submission system. Therefore, an applicant will be allowed to submit its application for the applied-for gTLD string which is deemed “invalid” or the applied-for variant label which is deemed “invalid” or “blocked” according to the initial algorithmic check.

Rationale for Final Recommendation 3.24: In the event that the DNS Stability Panel has correctly assessed an applied-for gTLD string as “invalid” or “blocked” (where the applied-for string is a variant label), the EPDP Team agreed that such a string will be disqualified unless and until it is deemed valid and allocatable in a future version of the RZ-LGR, if any. If and when such a string becomes allocatable, a new application has to be submitted in a future round if that string is sought by any applicant.

By way of example, if the DNS Stability Panel has correctly assessed the applied-for primary gTLD string as “valid” but the applied-for variant label as “invalid” and/or “blocked”, the applied-for primary gTLD string can still proceed in the application process without that variant label. However, if the applied-for primary gTLD string is correctly assessed as “invalid”, the entire

¹⁰¹ In considering question a3), it was necessary for the EPDP Team to make assumptions about the possible process flow for a subsequent new gTLD application process. Many of these assumptions were based on the 2012 Applicant Guidebook and process, notwithstanding that the RZ-LGR did not exist at that time. Recognizing that the Implementation Review Team is expected to develop the implementation details for the future round of the New gTLD Program, the EPDP Team agreed on the assumed process flow and used it as a tool to assist in its development of the recommendation and implementation guidance pertaining to charter question a3). See details here: <https://community.icann.org/download/attachments/176622713/EPDP%20Team%20Meeting%20%2313%20Slides.pdf?version=1&modificationDate=1636142182000&api=v2>

¹⁰² SubPro PDP recommends a limited challenge/appeal mechanism that applies to several types of evaluations and formal objections decisions, including the DNS Stability aspect of evaluation/challenge procedures. See details in SubPro PDP Recommendations and Implementation Guidance under Topic 32 Limited Challenge / Appeal Mechanism (specifically, Recommendations 32.1, 32.2, and 32.10 and Implementation Guidance 32.3/32.4/32.5/32.6/32.7/32.9/32.11/32.12/32.13), as well as the DNS Stability Process in Annex F in the SubPro PDP Final Report: <https://gnso.icann.org/sites/default/files/file/field-file-attach/final-report-newgtld-subsequent-procedures-pdp-02feb21-en.pdf>. However, SubPro PDP Recommendation 32.1 had not yet been adopted by the ICANN Board at the time this recommendation was developed. In the event the ICANN Board determines non-adoption of this SubPro PDP Output, the EPDP Team recommends that a limited challenge mechanism for DNS Stability Review still be developed as set out in [Final Recommendation 3.22](#). If the Board decides to adopt, the limited challenge mechanism as recommended by SubPro PDP would be fit for purpose.

application is ineligible to proceed. This is consistent with [Final Recommendation 3.1](#), which provides that an application for a variant label cannot precede the application for its primary string.

An applicant who believes that the disqualified gTLD string should be valid and allocatable may be advised to submit a review request to the relevant script Generation Panel directly or through ICANN org, at any time, to review its proposal to update the RZ-LGR. The RZ-LGR review is an existing process independent from the New gTLD Program and conducted by the relevant script Generation Panel to reconsider the validity and disposition of the string that is specifically requested for review. The outcome of the RZ-LGR review may or may not result in an update of the RZ-LGR. The EPDP Team further agreed that any ongoing processes pursuant to an RZ-LGR review should not hold up the other applications and the strings subject to the RZ-LGR review should not impact the evaluation of other applied-for gTLD strings.

A3 Public Comment Review:

Final Recommendations 3.22-3.23: Several commenters supported these recommendations as written.

Final Recommendation 3.24: Prompted by an input received from Public Comment, the EPDP Team confirmed that there is no expectation for ICANN org to continue monitoring potential updates to the RZ-LGR in relation to the disqualified gTLD strings. The EPDP Team added in the rationale that a new application has to be submitted if and when such a string becomes allocatable based on a future version of RZ-LGR, if that string is sought by any applicant.

4.4 String Similarity Review

E3 Charter Question:

In the Initial Evaluation for new gTLD applications, a proposed applied-for TLD is checked against several criteria as part of the string similarity review process (see gTLD Applicant Guidebook, version 2012-06-04, section 2.2.1.1.1).¹⁰³ The SubPro PDP affirmed these standards, while proposing recommendations and implementation guidance to enhance the process.¹⁰⁴

The WG and the SubPro IRT to coordinate to ensure consistency in the implementation of the string similarity review procedure for variant label applications of existing and future gTLDs.¹⁰⁵

E3 Final Recommendations:

Final Recommendation 4.1: The String Similarity Review must be modified to compare an applied-for primary gTLD string (no matter whether it is an ASCII string or an IDN string) and all of its allocatable variant label(s) against the following:

- 4.1.1 Existing gTLDs and all of their allocatable and blocked variant labels; and
- 4.1.2 Existing ccTLDs and all of their allocatable and blocked variant labels; and
- 4.1.3 Strings requested as IDN ccTLDs and all of their allocatable and blocked variant labels; and
- 4.1.4 Other applied-for gTLD strings and all of their allocatable and blocked variant labels; and

¹⁰³ These criteria are: existing TLDs and reserved names; other applied-for strings; strings requested as IDN ccTLDs; and applied-for 2-character IDN gTLD strings against every other single character and any other 2-character ASCII string.

¹⁰⁴ See “Topic 24: String Similarity Evaluations” in the SubPro PDP Final Report, pp.108-114:

<https://gnso.icann.org/sites/default/files/file/field-file-attach/final-report-newgtd-subsequent-procedures-pdp-02feb21-en.pdf#page=108>

¹⁰⁵ The Staff Paper recommends that the string similarity process to compare strings under consideration not just against all allocated or applied-for strings, but also all variant labels of those strings (including allocatable, withheld-same-entity, and blocked). For example, if a string is merely withheld-same-entity and a second string is visually similar, then allocating the second string undermines the predictability of the outcome of variant processing from the RZ-LGR. Similarly, if a string is blocked under the RZ-LGR, but a visually similar string is allocatable, then the second (visually similar) string might become a “work around” for the blocked string. This approach is maximally conservative. It is nevertheless worth noting that this expands considerably the number of strings that might need to be considered; the entire similarity review process will consequently probably become more expensive to operate. See Section 3.8 Adjustments in String Similarity Process in the Staff Paper, pp.18-19:

<https://www.icann.org/en/system/files/files/idn-variant-tld-recommendations-analysis-25jan19-en.pdf#page=18>

Staff Paper further recommends that in the event that two or more applied-for variant labels are visually similar, they may only be allocated if they are associated with the same variant set and are being requested by the same entity. In case of such conflicts across variant labels, the entire IDL set gets processed as one contention set; if one of the labels is already allocated, the contention is resolved in favor of the current operator. The Staff Paper recommends that it is necessary to perform the visual similarity checks for every requested-to-be-allocated variant in any given set against all the possible variant labels in every other set. This is because such an available variant could be requested at any time in the future. See Section 3.8.1 in the Staff Paper, pp.20-21: <https://www.icann.org/en/system/files/files/idn-variant-tld-recommendations-analysis-25jan19-en.pdf#page=20>

- 4.1.5 All strings on the New gTLD Program Reserved Names list and all of their allocatable and blocked variant labels;¹⁰⁶ and
- 4.1.6 Any other two-character ASCII strings and all of their allocatable and blocked variant labels.¹⁰⁷

In addition, the blocked variant label(s) of an applied-for primary gTLD string must also be compared against the following:

- 4.1.7 Existing gTLDs and all of their allocatable variant labels; and
- 4.1.8 Existing ccTLDs and all of their allocatable variant labels; and
- 4.1.9 Strings requested as IDN ccTLDs and all of their allocatable variant labels; and
- 4.1.10 Other applied-for gTLD strings and all of their allocatable variant labels; and
- 4.1.11 All strings on the New gTLD Program Reserved Names list and all of their allocatable variant labels; and
- 4.1.12 Any other two-character ASCII strings and all of their allocatable variant labels.¹⁰⁸

Final Recommendation 4.2: As an exception to the proposed modification to the String Similarity Review in accordance with [Final Recommendation 4.1](#), the String Similarity Review Panel may decide whether and what blocked variant labels to omit when conducting a comparison. Any such decision by the String Similarity Review Panel must be based on guidelines and/or criteria that justify such an omission on the basis of a manifestly low level of confusability between the scripts of labels being compared.

Final Recommendation 4.3: During implementation, the guidelines and/or criteria must be developed for use by the String Similarity Review Panel to decide on the omission of blocked

¹⁰⁶ See section 2.2.1.2.1 of the 2012 Applicant Guidebook. SubPro affirmed the standard used in the String Similarity Review from the 2012 round, which includes the comparison between the applied-for string with Reserved Names. SubPro also recommends adding “PTI” to the New gTLD Program Reserved Names list. See Recommendation 21.4 and Affirmation 24.2 in SubPro PDP Final Report, pp.95 and 108: <https://gnso.icann.org/sites/default/files/file/field-file-attach/final-report-newgtld-subsequent-procedures-pdp-02feb21-en.pdf#page=95>. The EPDP Team also recommends not to expand the New gTLD Program Reserved Names list to include their variant labels, but no application for a variant label of a Reserved Name is allowed. See [Final Recommendations 3.18-3.19](#) for details.

¹⁰⁷ See section 2.2.1.1.1 of the 2012 Applicant Guidebook. SubPro affirmed the standard used in the String Similarity Review from the 2012 round, which includes the comparison between an applied-for two-character IDN gTLD string against any other two-character ASCII strings. See Affirmation 24.2 in SubPro PDP Final Report, p.108: <https://gnso.icann.org/sites/default/files/file/field-file-attach/final-report-newgtld-subsequent-procedures-pdp-02feb21-en.pdf#page=108>. The EPDP Team accepted a suggestion raised in Public Comment to remove the limitation of “two-character IDN gTLD string” for the applied-for string, in the comparison against two-character ASCII strings. Essentially, the EPDP Team agreed that any applied-for gTLD string, no matter how many characters it has or which script it is written in, must be compared against two-character ASCII strings based on the Hybrid Model. This would enhance the String Similarity Review to catch any applied-for string which may be potentially confusable with a two-character ASCII combination.

¹⁰⁸ In the context of recommendations in this Phase 1 Final Report, a “blocked” label refers to either: 1) a label within the same script that is deemed valid as a top-level domain by the RZ-LGR but unavailable for allocation or delegation; or 2) a mixed-script blocked label permitted by the RZ-LGR as an exception (i.e., only Japanese has such an exception). To be clear, the “blocked” variant labels in this Phase 1 Final Report do not include the labels created by mixing different scripts. Such mixed-script labels are not eligible to be top-level domains with the exception of Japanese.

variant labels when conducting a comparison.

E3 Rationale for Final Recommendations:

Rationale for Final Recommendations 4.1-4.3: The EPDP Team supports the standard used in the String Similarity Review affirmed by the SubPro PDP, in order to mitigate visual similarities between strings that would create a probability of user confusion. The EPDP Team had significant discussion on whether and how the scope of the String Similarity Review should be modified to address the delegation of variant labels. Specifically, the EPDP Team considered at length the role of allocatable and blocked variant labels in the String Similarity Review process.

The EPDP Team began its deliberations on the role of variant labels by discussing three possible levels of comparison for visual confusability between applied-for gTLD strings and existing TLDs, as summarized in the **Table 1** below.

● **Table 1: Three Possible Levels of Comparison**

	Compare	Against
Level 1 (only applied-for strings + only requested allocatable variant labels)	<ul style="list-style-type: none"> ● Each applied-for gTLD string (as the primary gTLD string) ● Only requested allocatable variant labels of the applied-for primary gTLD string 	<ul style="list-style-type: none"> ● All existing gTLDs and ccTLDs and only requested allocatable variant labels of those TLDs ● Other applied-for primary gTLD strings and only requested allocatable variant labels of those strings ● All requested primary ccTLD strings and only requested allocatable variant labels of those strings
Level 2 (applied-for strings + all allocatable variant labels)	<ul style="list-style-type: none"> ● Each applied-for primary gTLD string ● All allocatable variant labels of the applied-for primary gTLD string 	<ul style="list-style-type: none"> ● All existing gTLDs and ccTLDs and all allocatable variant labels of those TLDs ● Other applied-for primary gTLD strings and all allocatable variant labels of those strings ● All requested primary ccTLD strings and all allocatable variant labels of those strings

<p>Level 3 (applied-for strings + all allocatable variant labels + all blocked variant labels)</p>	<ul style="list-style-type: none"> • Each applied-for primary gTLD string • All allocatable variant labels of the applied-for primary gTLD string • All blocked variant labels of the applied-for primary gTLD string 	<ul style="list-style-type: none"> • All existing TLDs and all allocatable and blocked variant labels of those TLDs • Other applied-for primary gTLD strings and all allocatable and blocked variant labels of those strings • All requested primary ccTLD strings and all allocatable and blocked variant labels of those strings
--	--	---

- **Illustration 1:** This is a visual representation of the three possible levels of comparison. P1 is the applied-for primary gTLD string, which has one allocatable variant label P1v1 that is also requested by the applicant, one allocatable variant label P1v2 that is not requested by the applicant, and one blocked variant label P1v3. On the right side of the illustration, the strings and their variant labels are what P1 and its variant labels are being compared against on the basis of visual confusability. The illustration intends to showcase the diversity of the strings being compared in the String Similarity Review. Some strings do not have any variant labels while some others have multiple. None, one, or more variant labels may be requested.

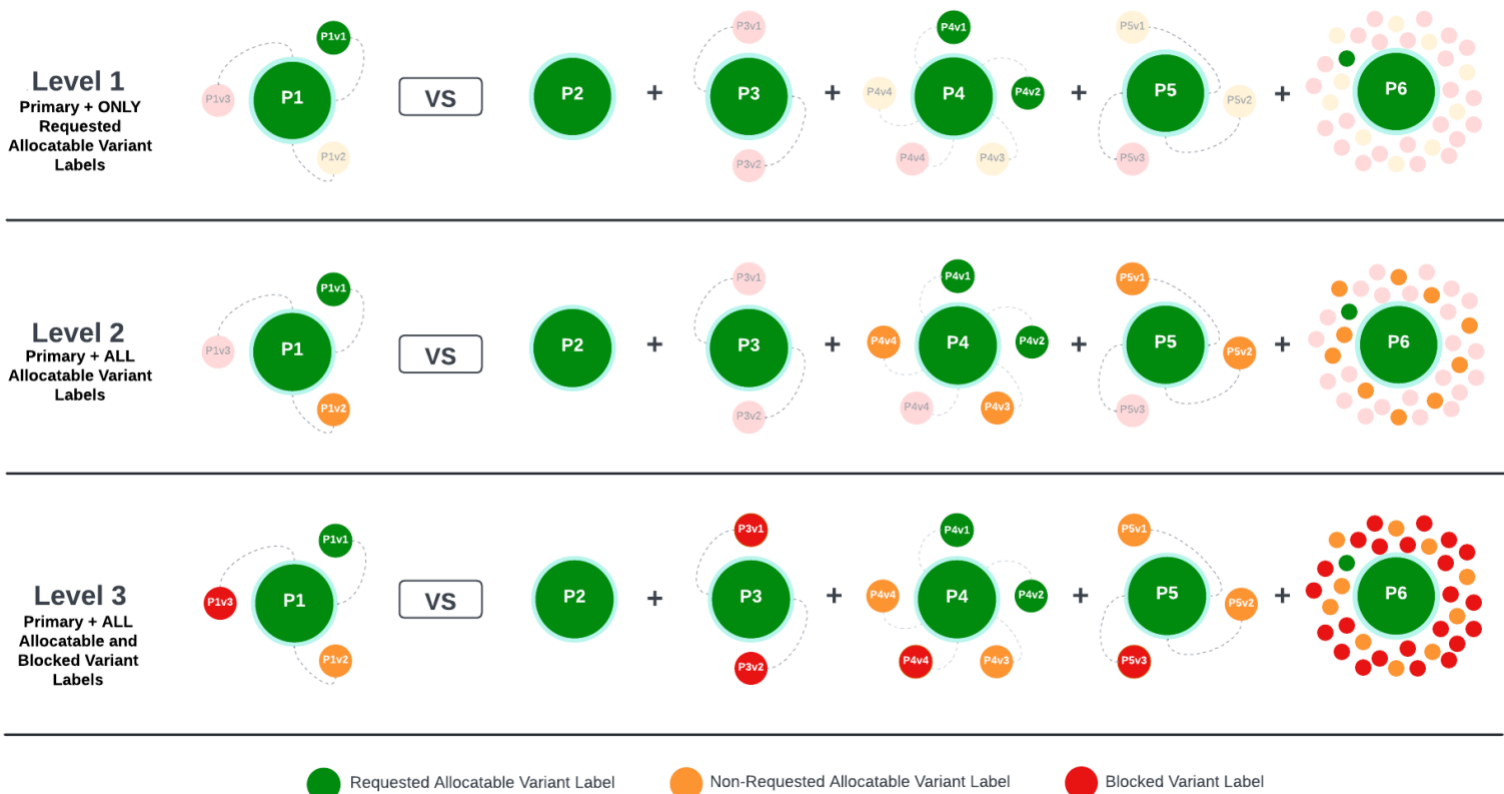

Following considerable discussion, the EPDP Team expressed support for a mixed-level approach between Level 2 and Level 3, which became known as the “Hybrid Model”. This Hybrid Model was the result of substantial work undertaken by the EPDP Team’s String Similarity Review small group, which was convened and tasked with putting forward recommendations to the EPDP Team on the level of comparison appropriate for String Similarity Review. The small group based its work on concrete examples of strings that have variant labels which may be visually confusable with other strings in the same or different scripts. A more detailed account of the small group’s work and the EPDP Team’s discussions of the Hybrid Model is included in Annex A: String Similarity Review Hybrid Model Deliberation.

In the Hybrid Model, visual checks under the String Similarity Review are performed for every applied-for primary gTLD string, whether it is an ASCII string or an IDN string, and its allocatable and blocked variant labels (collectively, the variant label set of the applied-for primary gTLD string). In addition, the Hybrid Model includes comparison with 1) New gTLD Program Reserved Names and all of their allocatable and blocked variant labels; and 2) any other two-character ASCII strings and all of their allocatable and blocked variant labels. This follows the standard used in the String Similarity Review affirmed by the SubPro PDP. Every combination of comparison is included in this model except for every blocked variant label against other blocked variant labels.

The Hybrid Model is summarized in the following **Table 2** and **Table 3**, which attempt to present how the strings are being compared in two ways.

- **Table 2: One way to present the String Similarity Review Hybrid Model**

	Compare	Against
Hybrid Model	<ul style="list-style-type: none"> ● Each applied-for gTLD string (as the primary gTLD string) ● All allocatable variant labels of the applied-for primary gTLD string 	<ul style="list-style-type: none"> ● All existing gTLDs and ccTLDs and all allocatable and blocked variant labels of those TLDs ● All other applied-for primary gTLD strings and all allocatable and blocked variant labels of those strings ● All requested primary ccTLD strings and all allocatable and blocked variant labels of those strings ● All strings on the New gTLD Program Reserved Names list and all allocatable and blocked variant labels of those strings

		<ul style="list-style-type: none"> Any other two-character ASCII strings and all of their allocatable and blocked variant labels
	<ul style="list-style-type: none"> All blocked variant labels of each applied-for primary gTLD string 	<ul style="list-style-type: none"> All existing gTLDs and ccTLDs and all allocatable variant labels of those TLDs All other applied-for gTLD strings and all allocatable variant labels of those strings All requested primary ccTLD strings and all allocatable variant labels of those strings All strings on the New gTLD Program Reserved Names list and all allocatable variant labels of those strings Any other two-character ASCII strings and all of their allocatable variant labels

• **Table 3:** An alternative way to present the String Similarity Review Hybrid Model

		An applied-for primary gTLD string		
		An applied-for primary gTLD string	All of its allocatable variant label(s)	All of its blocked variant label(s)
All Existing gTLDs	All existing gTLDs	Compare	Compare	Compare
	All of their allocatable variant labels	Compare	Compare	Compare
	All of their blocked variant labels	Compare	Compare	Do not compare
All existing ccTLDs	All existing ccTLDs	Compare	Compare	Compare
	All of their allocatable variant labels	Compare	Compare	Compare

		An applied-for primary gTLD string		
		An applied-for primary gTLD string	All of its allocatable variant label(s)	All of its blocked variant label(s)
	All of their blocked variant labels	Compare	Compare	Do not compare
All applied-for gTLD strings	All applied-for gTLD strings	Compare	Compare	Compare
	All of their allocatable variant labels	Compare	Compare	Compare
	All of their blocked variant labels	Compare	Compare	Do not compare
All requested ccTLD strings	All requested ccTLD strings	Compare	Compare	Compare
	All of their allocatable variant labels	Compare	Compare	Compare
	All of their blocked variant labels	Compare	Compare	Do not compare
All strings on the New gTLD Program Reserved Names list	All Reserved Names	Compare	Compare	Compare
	All of their allocatable variant labels	Compare	Compare	Compare
	All of their blocked variant labels	Compare	Compare	Do not compare
Any other two-character ASCII strings	Any other two-character ASCII strings	Compare	Compare	Compare
	All of their allocatable variant labels	Compare	Compare	Compare
	All of their blocked variant labels	Compare	Compare	Do not compare

To further explain the String Similarity Review Hybrid Model with concrete examples, the following illustrations show how the comparison of two primary gTLD strings in the Arabic script would be conducted.¹⁰⁹

- **Illustration 2:** Applied-for primary string A1 has two allocatable variant labels and 21 blocked variant labels according to RZ-LGR calculation; applied-for primary string B1 doesn't have allocatable variant labels but 31 blocked variant labels.

Applied-for Primary Strings:	رکی (A1)	رگے (B1)
Allocatable Variants of Primary Strings:	رکی (A2) رکی (A3)	None
Blocked Variants of Primary Strings:	رکی (A4) رکی (A15) رکی (A5) رکی (A16) رکی (A6) رکی (A17) رکی (A7) رکی (A18) رکی (A8) رکی (A19) رکی (A9) رکی (A20) رکی (A10) رکی (A21) رکی (A11) رکی (A22) رکی (A12) رکی (A23) رکی (A13) رکی (A24) رکی (A14)	رگے (B2) رگے (B13) رگے (B24) رگے (B3) رگے (B14) رگے (B25) رگے (B4) رگے (B15) رگے (B26) رگے (B5) رگے (B16) رگے (B27) رگے (B6) رگے (B17) رگے (B28) رگے (B7) رگے (B18) رگے (B29) رگے (B8) رگے (B19) رگے (B30) رگے (B9) رگے (B20) رگے (B31) رگے (B10) رگے (B21) رگے (B32) رگے (B11) رگے (B22) رگے (B12) رگے (B23)

- **Illustration 3:** This shows how the comparison is done in the Hybrid Model. A1 is compared against B1, B2, B3...B32; A2 is compared against B1, B2, B3...B32; A3 is compared against B1, B2, B3...B32; and B1 is compared against A4, A5, A6...A24. Essentially all the labels in the two sets are compared against each other, with the exception of comparing the blocked variant labels (A4-A24) of primary string A1 against the blocked variant labels (B2-B32) of primary string B1.

¹⁰⁹ The String Similarity Review small group developed these example strings and considered how they would be compared in the String Similarity Review using the Hybrid Model. To learn more about the small group's deliberations, see Annex A in this Final Report.

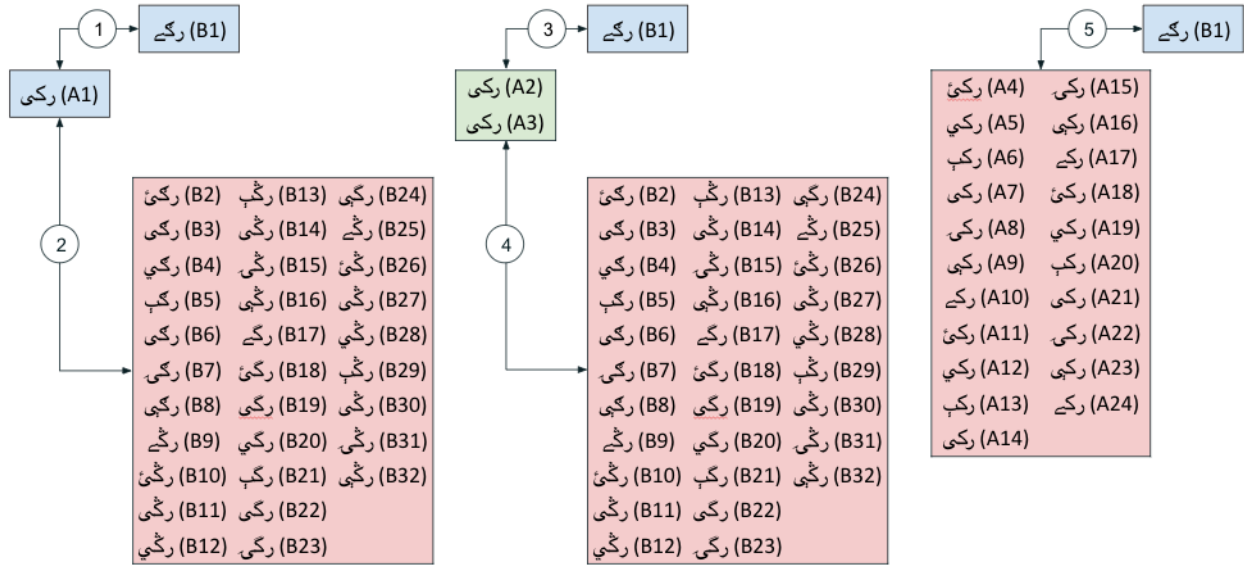

- **Illustration 4:** This shows the variant labels that may be found to be confusingly similar as a result of the Hybrid Model. Even though the applied-for primary string A1 and primary string B1 may not be confusingly similar, confusing similarity may be found when their variant labels are taken into consideration. Those visual similarities won't be detected if only Level 1 or Level 2 of comparison is used in the String Similarity Review.

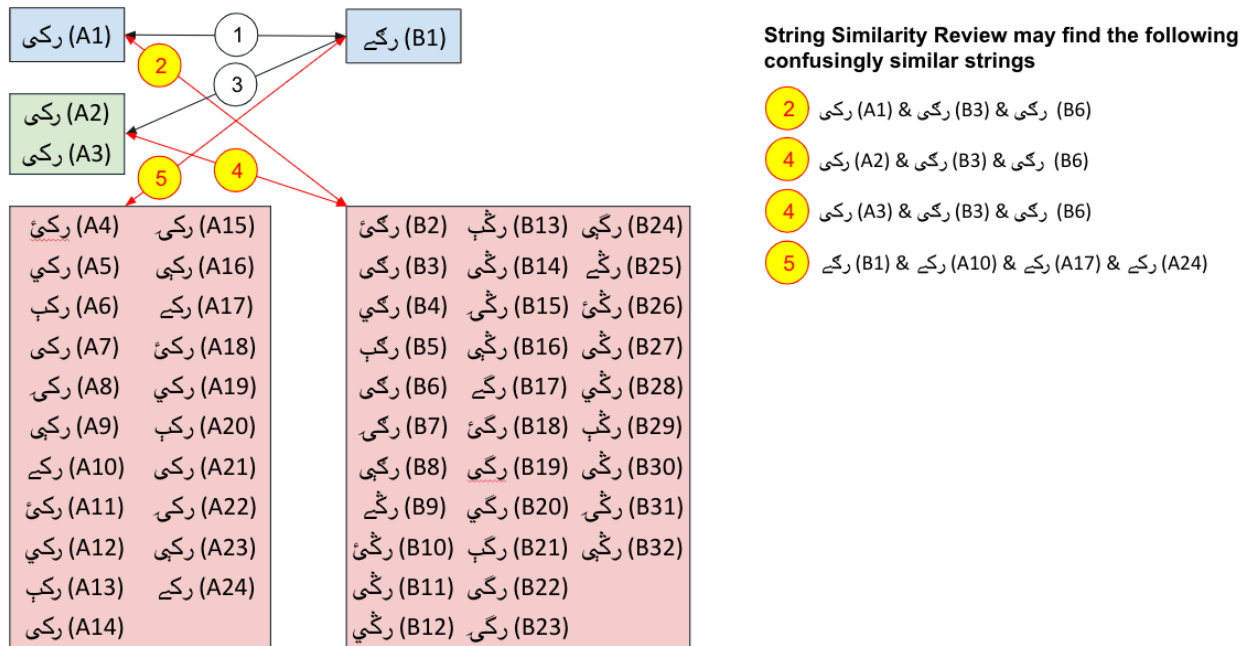

The Hybrid Model is designed to mitigate the potential risk from two types of “failure modes” defined in SAC060, which can be caused by delegating confusingly similar strings:

- **“Denial of service” or “no-connection”:** a user attempts to visit http://example.Y, reading it as being the same as the http://example.X that, for example, he or she saw in

an advertisement, but the connection does not work because `http://example.X` is not registered.¹¹⁰

- “**Misconnection**”: a user attempts to visit `http://example.Y`, reading it as being the same as the `http://example.X` that, for example, he or she saw in an advertisement, but arrives at a site controlled by a registrant different to that of `http://example.X`.¹¹¹

The EPDP Team generally agreed that while denial of service/no-connection failure mode may be a nuisance for users, the misconnection risk may be more problematic and could result in harm through exploitation of user confusion. It was acknowledged that arriving at the wrong site, even if a legitimate site, can result in credential compromise and accidental exposure of information. If the confusing similarity among domain names is maliciously leveraged, it can be a DNS abuse vector. The EPDP Team also noted that confusion at the top-level, which may be exacerbated by the introduction of gTLD variant labels, increases the possibility of DNS abuse more than that at the second-level.

The EPDP Team acknowledged the efficacy of the Hybrid Model in detecting more combinations of visually confusable strings in the String Similarity Review compared to Level 1 or Level 2 analysis, and hence helps reduce the likelihood of risks associated with the two aforementioned failure modes, which would otherwise be missed if blocked variant labels were not required to be a part of the analysis.¹¹²

By excluding the need to compare blocked variant labels of an applied-for primary gTLD string against blocked variant labels of *inter alia* other existing TLDs, other applied-for primary gTLD strings, and requested primary ccTLD strings, the Hybrid Model eliminates what the EPDP Team considered to be clearly unnecessary computational and evaluation complexity, as none of the blocked variant labels can be delegated, and therefore similarities between non-existing labels should not cause user confusion. On the other hand, an allocatable variant label that has yet to be applied for retains the potential to cause user confusion and therefore is required to be compared.

The EPDP Team recognized that the Hybrid Model would introduce some significant computational and evaluation complexity in the String Similarity Review, and any increase in the complexity would likely add to the cost of application evaluation.¹¹³ From a risk assessment angle, the EPDP Team sought to understand whether the complexity that the Hybrid Model would introduce was commensurate with the “likelihood” and the “severity” of risks from the two aforementioned failure modes.

In considering the risk assessment model developed by ICANN org support staff, the EPDP Team found it challenging to quantify the “likelihood” and the “severity” of the two risks, even with

¹¹⁰ The term “denial of service” should not be confused with Distributed Denial of Service (DDOS). The SAC060 advice coined this term to indicate the “no connection” scenario described above.

¹¹¹ See Recommendation 7 in “SAC060, SSAC Comment on Examining the User Experience Implications of Active Variant TLDs Report”, p.14: <https://www.icann.org/en/system/files/files/sac-060-en.pdf#page=14>

¹¹² To understand why blocked variant labels should also be included in String Similarity Review, the small group discussed a use case where a blocked variant label may play a role in the resulting “misconnection”. See **Illustration 1** in Annex A in this Final Report.

¹¹³ See more details about the cost/benefit analysis of the Hybrid Model in Annex A.

the understanding that the risk assessment model relied on individual professional judgment.¹¹⁴ Some EPDP Team members felt that this risk assessment would be far less beneficial, given their perspective that relevant data would be needed to formulate professional judgment, and that data does not exist.

Following further deliberations, the EPDP Team also indicated some support for an exception to the Hybrid Model. The exception is that the String Similarity Review Panel may decide whether and what blocked variant labels to omit when conducting a comparison on the basis of a manifestly low level of confusability between the scripts of the labels being compared. The omitted blocked variant labels can be the ones associated with any category of strings mentioned in the Hybrid Model, including existing TLDs, applied-for gTLD strings, requested ccTLD strings, New gTLD Program Reserved Names, and two-character ASCII strings. Any such decision by the String Similarity Review Panel must be based on guidelines and/or criteria, to be developed during implementation, that justify such an omission. It was suggested that additional research or study could potentially be done during implementation of the EPDP Team recommendations to identify such scripts and inform whether the inclusion of blocked variant label(s) in the String Similarity Review is necessary.

E3 Public Comment Review:

Final Recommendation 4.1: The EPDP Team accepted a suggestion raised in Public Comment to provide a numbered list, replacing the original bullet list, to enhance clarity when referring to the specific elements of the Hybrid Model. The EPDP Team also agreed with a comment regarding the possibility that an applied-for string, which has more than two characters, may be found confusingly similar to a two-character ASCII string or its variant label. Hence, in 4.1.6 and 4.1.12, the EPDP Team agreed to remove any limitation with regard to the length of an applied-for gTLD string. In other words, no matter how many characters an applied-for primary gTLD string has, it will be compared against two-character ASCII strings; their variant labels will also be compared against each other based on the Hybrid Model.

Final Recommendation 4.2: Based on an input received after public comment, the EPDP Team added a clarification in the rationale that the omitted blocked variant labels can be the one associated with any category of strings mentioned in the Hybrid Model, at the discretion of the String Similarity Review Panel.

Final Recommendation 4.3: Several commenters supported this recommendation as written.

E3a Charter Question:

After a requested variant string is rejected as a result of a string similarity review, should the other variant strings in the same variant set remain allocatable? Should individual labels be

¹¹⁴ To learn more about the risk assessment model, see Annex A in this Final Report. For additional details, see the presentation slides, recording, and notes for meeting #63 <https://community.icann.org/x/PYYFDQ> on 22 December 2022 and meeting #64 <https://community.icann.org/x/X5E-DQ> on 5 January 2023.

allowed to have different outcomes/actions (e.g., some labels be blocked and some be allowed to continue with an application process)?¹¹⁵

E3a Final Recommendations:

Final Recommendation 4.4: All labels from a variant label set, comprising the primary gTLD string and all of its allocatable and blocked variant labels, must share the same outcome out of the String Similarity Review. This means the String Similarity Review, in accordance with Final Recommendations 4.1-4.3, determines that:

4.4.1 If an applied-for primary gTLD string or any of its variant label(s) is confusingly similar to an existing gTLD, an existing ccTLD, a New gTLD Program Reserved Name, a two-character ASCII string, or any of the variant label(s) of the aforementioned categories of strings, the entire variant label set of the applied-for primary gTLD string will be ineligible to proceed in the application process; or

4.4.2 If an applied-for primary gTLD string or any of its variant label(s) is confusingly similar to another applied-for primary gTLD string or any of its variant label(s), the entire variant label sets of the two applied-for primary gTLD strings will be placed in a contention set. Upon the resolution of the contention set, the application that prevails can proceed to the next stage of the application process.¹¹⁶

4.4.3 If an applied-for primary gTLD string or any of its variant label(s) is confusingly similar to a requested primary IDN ccTLD string or any of its variant label(s), ICANN org is expected to take the following approach to resolve the conflict:

4.4.3.1 If one of the applied-for primary TLD strings has completed its respective process before the other is lodged, that primary TLD string (and its approved variant label(s), if applicable) will be delegated.

4.4.3.1.1 An applied-for primary gTLD string that has successfully completed all relevant evaluation stages, including dispute resolution and string contention, if applicable, and is eligible for entry into a registry agreement will be considered complete, and therefore that gTLD application (primary gTLD string and applied-for variant label(s),

¹¹⁵ The Staff Paper recommends that the following outcomes may be considered: 1) only the variant label requested for delegation is rejected. For example, the requested variant t1v2 of top-level label t1 will get rejected while t1v1 and t1v3 from the same variant set continue to remain allocatable; or 2) the entire variant set is rejected. For example, the requested variant t1v2 of top-level label t1 will get rejected including t1v1 and t1v3 from the same variant set as t1v2. This outcome appears to be difficult to justify, though an applicant could decide that, if it cannot receive t1v2 then it does not wish to proceed with the application. See Section 3.8.2 in the Staff Paper, pp.21: <https://www.icann.org/en/system/files/files/idn-variant-tld-recommendations-analysis-25jan19-en.pdf#page=21>

¹¹⁶ Note that in accordance with Final Recommendation 4.1-4.3, the String Similarity Review will exclude the comparison of a blocked variant label against other blocked variant labels. For example, if the blocked variant label of an applied-for primary gTLD string is confusingly similar to a blocked variant label of an existing gTLD, the application can proceed to the next stage of the application process. If the blocked variant label of an applied-for primary gTLD string is confusingly similar to a blocked variant label of another applied-for primary gTLD string, both applications can proceed to the next stage of the application process.

if applicable) would not be disqualified by a newly-filed IDN ccTLD request.

4.4.3.1.2 A requested primary IDN ccTLD that is validated will be considered complete and therefore that IDN ccTLD request (primary IDN ccTLD string and requested variant label(s), if applicable) would not be disqualified by a newly-filed gTLD application.¹¹⁷

4.4.3.2 In the case where neither application has completed its respective process, the gTLD application (including the applied-for variant label(s), if applicable) will be put on hold while the IDN ccTLD request (including the requested variant label(s), if applicable) is undergoing evaluation.

4.4.3.2.1 Where the gTLD application (including the applied-for variant label(s), if applicable) does not have the support or non-objection, when required, from the relevant government or public authority, the validated IDN ccTLD request (including the requested variant label(s), if applicable) will prevail and the gTLD application is not eligible to proceed in the application process.

4.4.3.2.2 Where the IDN ccTLD request (including the requested variant label(s), if applicable) is withdrawn or fails evaluation, the gTLD application (including the applied-for variant label(s), if applicable) is eligible to proceed in the application process.

4.4.3.3 In the case where the gTLD application (including the applied-for variant label(s), if applicable) has obtained the support or non-objection of the relevant government or public authority, but is ineligible to proceed due to conflict with an IDN ccTLD request, a full refund of the evaluation fee is available to the gTLD applicant if its application was submitted prior to the publication of the IDN ccTLD request.

4.4.4 If an applied-for primary gTLD string or any of its variant label(s) is confusingly similar to an applied-for primary gTLD string or any of its variant label(s) that has been held over from a previous application round and still in progress, the newly submitted application will be put on hold until the outcome of the application from the previous round has been determined.

4.4.4.1 If the application from a previous round successfully completes evaluation and is eligible for entry into a registry agreement, the entire variant label set of the newly applied-for primary gTLD string is ineligible to proceed in the application process.

4.4.4.2 If the application from a previous round is withdrawn or fails

¹¹⁷ The term “validated” essentially means successfully evaluated. This term was initially defined in the IDN ccTLD Fast Track Process Implementation and reaffirmed in the [ccPDP4 Initial Report](#). See the “Validation of IDN ccTLD Strings & Variants” section in the ccPDP4 Initial Report for more details.

evaluation, the newly submitted application is eligible to proceed to the next stage of the application process.

E3a Rationale for Final Recommendations:

Rationale for Final Recommendation 4.4: The EPDP Team agreed that a variant label set, which comprises a primary gTLD string and all of its allocatable and blocked variant labels, will be treated as one unit and be subject to the same consequences of the String Similarity Review.

As explained in the rationale for [Final Recommendations 4.1-4.3](#), the EPDP Team proposed that the String Similarity Review be modified to extend its visual similarity checks beyond just the applied-for primary gTLD string (no matter whether it is an ASCII string or an IDN string). The String Similarity Review is expected to include the entire variant label set of an applied-for primary gTLD string for the purpose of identifying risks of confusability in any of the labels from a variant label set, not just the applied-for primary gTLD string but also any of the allocatable or blocked variant label. If one label from the variant label set is found to carry a risk of confusability, the other labels from the variant label set may also carry the same risk by association, as the labels from the variant label set are regarded as the “same” by the communities who use the script to which the set is associated.

During the drafting of this Final Report, the EPDP Team recognized that the preliminary recommendation missed to address two scenarios regarding the confusing similarity found between: 1) an applied-for primary gTLD string (or its variant label) and a requested primary IDN ccTLD string (or its variant label); 2) an applied-for primary gTLD string (or its variant label) in one application round and an applied-for primary gTLD string (or its variant label) held over from a previous application round. In this final recommendation, the EPDP Team filled the gap by specifying the respective outcomes in these two scenarios. In particular, the process of resolving the conflict between an applied-for gTLD string (or its variant label) and a requested IDN ccTLD string (or its variant label) is consistent with that in the 2012 Applicant Guidebook.¹¹⁸ The EPDP Team noted that the reason “IDN ccTLD” is specified in 4.4.3 and its sub items is that 4.4.1 has already addressed the scenario where an applied-for primary gTLD string or any of its variant label(s) is found confusingly similar to an ASCII ccTLD string or any of its variant label(s). Furthermore, the underlying assumption behind 4.4.3.1 and its sub items is that as long as the applied-for primary gTLD string has successfully completed evaluation, its application (including the applied-for variant label(s), if applicable) would not be disqualified by a newly filed IDN ccTLD request. The reverse holds true as well. Furthermore, the EPDP Team noted that 4.4.3.2.1 specifically intends to address the scenario where a gTLD application, including but not limited to a Geographic Name TLD application, requires support or non-objection from the relevant government or public authority and it conflicts with an IDN ccTLD request due to visual similarity.

The EPDP Team recognized that mechanisms exist in the New gTLD Program to which relevant parties can avail themselves to dispute the outcomes of the String Similarity Review, including the objection processes. These mechanisms allow for the outcomes of the String Similarity

¹¹⁸ See Section 2.2.1.1.1.1 Reviews Performed in the 2012 Applicant Guidebook.

Review to be potentially changed, which in turn, could result in the reinstatement of applications or the removal of strings from a contention set.

E3a Public Comment Review:

Final Recommendation 4.4: Based on input received following the Public Comment proceeding, the EPDP Team noticed an oversight of missing the mention of New gTLD Program Reserved Names and two-character ASCII strings. 4.4.1 was revised to include these missing elements. The EPDP Team also added 4.4.3 and 4.4.4 and their sub items to fill the gaps identified during the Final Report drafting process. In addition, taking into account a suggestion received from Public Comment, the EPDP Team provided a numbered list, replacing the original bullet list, to enhance clarity.

4.5 Objection Processes

E2 Charter Question:

Under the rules of the most recent gTLD application round, there are four criteria for objections to a string (see gTLD Applicant Guidebook, version 2012-06-04, section 3.2.1).¹¹⁹ The SubPro PDP has also affirmed the continuation of these four criteria for objections to a string, while proposing recommendations and implementation guidance to enhance/adjust these criteria.¹²⁰

The WG and the SubPro IRT to coordinate to ensure consistency in the implementation of the objection process for the variant label applications of existing and future TLDs.

E2 Final Recommendations:

Final Recommendation 5.1: All applied-for allocatable gTLD variant labels must be subject to the objection processes.

Final Recommendation 5.2: A String Confusion Objection may be filed based on confusing similarity between combinations of applied-for primary gTLD strings and their variant labels established by [Final Recommendations 4.1-4.2](#). The possible combinations are as follows:

- 5.2.1 Applied-for primary gTLD string is confusingly similar to the primary string of an existing gTLD/ccTLD or another applied-for primary gTLD string
- 5.2.2 Applied-for primary gTLD string is confusingly similar to an allocatable variant label of an existing gTLD/ccTLD or another applied-for primary gTLD string
- 5.2.3 Applied-for primary gTLD string is confusingly similar to a blocked variant label of an existing gTLD/ccTLD or another applied-for primary gTLD string
- 5.2.4 An allocatable variant label of an applied-for primary gTLD string is confusingly similar to the primary string of an existing gTLD/ccTLD or another applied-for primary gTLD string
- 5.2.5 An allocatable variant label of an applied-for primary gTLD string is confusingly similar to an allocatable variant label of an existing gTLD/ccTLD or another applied-for primary gTLD string
- 5.2.6 An allocatable variant label of an applied-for primary gTLD string is confusingly similar to a blocked variant label of an existing gTLD/ccTLD or another applied-for primary gTLD string
- 5.2.7 A blocked variant label of an applied-for primary gTLD string is confusingly similar to the primary string of an existing gTLD/ccTLD or another applied-for primary gTLD string

¹¹⁹ The four criteria are: String Confusion Objection; Legal Rights Objection; Limited Public Interest Objection; and Community Objection.

¹²⁰ See "Topic 31: Objections" in the SubPro PDP Final Report, pp.145-154:

<https://gnso.icann.org/sites/default/files/file/field-file-attach/final-report-newgtd-subsequent-procedures-pdp-02feb21-en.pdf#page=145>

5.2.8 A blocked variant label of an applied-for primary gTLD string is confusingly similar to an allocatable variant label of an existing gTLD/ccTLD or another applied-for primary gTLD string¹²¹

The only combination of strings that cannot form the basis of a String Confusion Objection is that of a blocked variant label of an applied-for primary gTLD string being claimed as confusingly similar to the blocked variant label of an existing gTLD/ccTLD or another applied-for primary gTLD string. In its objection, the objector must specify the confusing similarity between the combination of strings within the limits of String Similarity Review in accordance with [Final Recommendations 4.1-4.2](#).

Final Recommendation 5.3: The outcomes of the String Confusion Objection are consistent with the 2012 Applicant Guidebook. Specifically:

- 5.3.1 If the objection prevails and where the objector is an existing TLD registry operator, then that entire application is ineligible to proceed to the next stage of the application process; or
- 5.3.2 If the objection prevails and where the objector is another applicant, then the entire variant label sets in both that application and the objector’s application must be placed in a contention set.
- 5.3.3 If the objection does not prevail, then that entire application may proceed to the next stage of the application process.

Final Recommendation 5.4: With respect to the Limited Public Interest Objection, Legal Rights Objection, and Community Objection, an objection may be filed against only the applied-for primary gTLD strings and/or the applied-for allocatable variant labels. For avoidance of doubt, the objection cannot be filed against non-applied-for allocatable variant labels or blocked variant labels. Specifically, the objection can be filed against one of the following options:

- 5.4.1 Only the applied-for primary gTLD string, or
- 5.4.2 One or more of the applied-for allocatable variant label(s), or
- 5.4.3 A combination of the applied-for primary gTLD string and one or more applied-for allocatable variant label(s)

Final Recommendation 5.5: With respect to the Limited Public Interest Objection, Legal Rights Objection, and Community Objection, the possible outcomes are as follows:

- 5.5.1 If an objection against an applied-for primary gTLD string prevails, then that entire application is ineligible to proceed to the next stage of the application process.
- 5.5.2 If an objection against only one or more applied-for allocatable variant label(s) prevails, then that application for the applied-for primary gTLD string and other

¹²¹ In the context of recommendations in this Phase 1 Final Report, a “blocked” label refers to either: 1) a label within the same script that is deemed valid as a top-level domain by the RZ-LGR but unavailable for allocation or delegation; or 2) a mixed-script blocked label permitted by the RZ-LGR as an exception (i.e., only Japanese has such an exception). To be clear, the “blocked” variant labels in this Phase 1 Final Report do not include the labels created by mixing different scripts. Such mixed-script labels are not eligible to be top-level domains with the exception of Japanese.

unaffected applied-for allocatable variant label(s) may proceed to the next stage of the application process without the applied-for allocatable variant label(s) which are rendered ineligible by the objection.

5.5.3 If the objection does not prevail, then that entire application may proceed to the next stage of the application process.

E2 Rationale for Final Recommendations:

Rationale for Final Recommendation 5.1: The EPDP Team agreed with the standard for the four types of objection processes, which has been affirmed by the SubPro PDP, and agreed that all allocatable gTLD variant labels sought by applicants must be subject to the objection processes.

Rationale for Final Recommendations 5.2-5.3: The EPDP Team affirmed the standard for String Confusion Objection as set out in the 2012 Applicant Guidebook, which has also been affirmed by SubPro PDP.¹²² However, the EPDP Team proposes adjustments to the String Confusion Objection by taking into account the introduction of gTLD variant labels. The EPDP Team agreed that the String Confusion Objection goes one step further than the String Similarity Review to prevent the “failure modes” by identifying confusingly similar strings not limited to visual similarity, but also aural similarity, similarity of meaning, etc.¹²³ Since the EPDP Team proposed modification to the String Similarity Review in accordance with Final Recommendations 4.1-4.3, it logically follows that a String Confusion Objection may be filed based on the confusing similarity between combinations of applied-for primary gTLD strings (no matter whether it is an ASCII string or an IDN string) and their variant labels established by Final Recommendations 4.1-4.2.

The EPDP Team agreed that the outcomes of the String Confusion Objection are consistent with what is set out in the 2012 Applicant Guidebook, which has also been affirmed by SubPro PDP.

Rationale for Final Recommendations 5.4-5.5: The EPDP Team affirmed the standard of the Limited Public Interest Objection, Legal Rights Objection, and Community Objection as set out in the 2012 Applicant Guidebook, which have also been affirmed by SubPro PDP.¹²⁴ In discussing potential adjustments to these types of objection processes by taking into account the introduction of gTLD variant labels, the EPDP Team analyzed the purposes of these types of objections, which are different from that of the String Confusion Objection for preventing the “failure modes”. Specifically, these types of objections are intended to prevent delegation of strings that contradict legal norms of morality and public order recognized under principles of international law (Limited Public Interest Objection), infringe the existing legal rights of the rightsholder (Legal Rights Objection), and have substantial opposition from a significant portion

¹²² See “Topic 31: Objections” in SubPro PDP Final Report, pp.145-150:

<https://gnso.icann.org/sites/default/files/file/field-file-attach/final-report-newgtld-subsequent-procedures-pdp-02feb21-en.pdf#page=145>

¹²³ For more details about the “failure modes”, see Recommendation 7 in “SAC060, SSAC Comment on Examining the User Experience Implications of Active Variant TLDs Report”, p.14: <https://www.icann.org/en/system/files/files/sac-060-en.pdf#page=14>

¹²⁴ See “Topic 31: Objections” in SubPro PDP Final Report, pp.145-150:

<https://gnso.icann.org/sites/default/files/file/field-file-attach/final-report-newgtld-subsequent-procedures-pdp-02feb21-en.pdf#page=145>

of the community that the applied-for gTLD targets (Community Objection). Therefore, the EPDP Team believes it is logical that those three objection types will be limited to only the applied-for primary gTLD strings and the applied-for allocatable variant labels that may actually be delegated as a result of the applications being approved.

In discussing the Legal Rights Objection and Community Objection, the EPDP Team also considered an alternative approach, in which the objection could also be filed against non-applied-for allocatable variant labels and blocked variant labels. It is intended to prevent the scenario where an existing primary gTLD may block the future chance for a rightsholder or a community to apply for a string that is the same or similar to a valid variant label of the existing primary gTLD. Based on the outcomes of the String Similarity Review as explained in [Final Recommendation 4.4](#), future applications for such strings may not be able to proceed due to visual similarity to a non-applied-for allocatable variant label or a blocked variant label of an existing primary gTLD.

In considering this alternative approach, the EPDP Team discussed possible consequences of a prevailing objection against different types of strings, including the primary gTLD string, applied-for allocatable variant label, non-applied-for allocatable variant label, and blocked variant label. The EPDP Team concluded that there is only one logical way to structure the outcomes. Regardless of the specific type of string the objection is filed against, if the objection prevails, the entire application is ineligible to proceed. As such, the very scenario the alternative approach intends to prevent can be prevented. In other words, in the event of a prevailing objection, a non-applied-for allocatable variant label or a blocked variant label could prevent the applicant from operating its actual applied-for primary gTLD string and applied-for allocatable variant label(s).

The EPDP Team determined that this alternative approach was overly conservative and inappropriate, hence recommending the limited approach, allowing these three types of objections to be filed against only the applied-for primary gTLD strings and/or the applied-for allocatable variant labels. The EPDP Team acknowledged that with the recommended approach, a delegated primary gTLD might block the chance for a rightsholder or a community to apply for another string that is the same or similar to any valid variant label of the existing primary gTLD, due to the modified String Similarity Review in accordance with [Final Recommendations 4.1-4.3](#). However, the EPDP Team recalls that the first-come-first-serve principle generally applies in the New gTLD Program and that it will similarly apply in these cases. In addition, the limited challenge mechanism recommended by SubPro PDP can be leveraged to potentially change the outcomes of the String Similarity Review, which may result in the reinstatement of applications for such strings.¹²⁵

It also logically follows that the outcome of a prevailing objection for these three types is limited. Specifically, if an objection against only one or more applied-for allocatable variant label(s) prevails, then that application for the applied-for primary gTLD string and other unaffected applied-for allocatable variant label(s) may proceed to the next stage of the

¹²⁵ See details of the limited challenge mechanism for String Similarity Review in the SubPro PDP Final Report, pp.329-330: <https://gnso.icann.org/sites/default/files/file/field-file-attach/final-report-newgtd-subsequent-procedures-pdp-02feb21-en.pdf#page=329>

application process without the applied-for allocatable variant label(s) which are rendered ineligible by the objection. However, if an objection against an applied-for primary gTLD string prevails, then that entire application is ineligible to proceed to the next stage of the application process. This is generally consistent with what is set out in the 2012 Applicant Guidebook, which has also been affirmed by SubPro PDP.

E2 Public Comment Review:

Final Recommendation 5.1: Several commenters supported this recommendation as written.

Final Recommendations 5.2-5.5: Taking into account a suggestion received from Public Comment, EPDP Team provided numbered lists, replacing the original bullet lists, to enhance clarity.

Final Recommendations 5.3 and 5.5: The EPDP Team considered a wording change suggested in Public Comment and agreed to use the phrase “that entire application”, replacing the original phrase “that application (in its entirety)”, in order to resolve any semantic inconsistencies and minimize potential for misinterpretation.

4.6 String Contention

E4 Charter Question:

Under current procedures, resolution of string contention for applied-for gTLD strings may include components such as a settlement between the parties, a community priority evaluation (if a community-based applicant in a contention set elects this option), and an auction. SubPro PDP affirmed these components while proposing recommendations and implementation guidance to enhance the mechanisms for string contention resolution.¹²⁶

The WG and the SubPro IRT to coordinate to ensure consistency in the implementation of the string contention resolution mechanism for variant label applications of existing and future new gTLDs.¹²⁷

E4 Final Recommendations:

Final Recommendation 6.1: An applied-for primary gTLD string that is also a variant label of another applied-for primary gTLD string, as calculated by the RZ-LGR, must be placed in a contention set.

Final Recommendation 6.2: If an applied-for primary gTLD string or its variant label is found to be confusingly similar to another applied-for primary gTLD string or its variant label, the entire variant label sets in the affected applications shall be placed in a contention set together.¹²⁸ This applies no matter whether the primary gTLD string is an ASCII string or an IDN string.

E4 Rationale for Final Recommendations:

Rationale for Final Recommendation 6.1: The EPDP Team noted that in the 2012 New gTLD Program, two or more applied-for gTLD strings that are variant labels of each other according to an IDN table submitted to ICANN would be considered in contention with one another. The SubPro PDP and the EPDP Team both affirmed that the RZ-LGR be the sole source to provide a consistent definition of variant labels for gTLDs. Thus, the EPDP Team agreed that it is logical to place the applied-for primary gTLD strings that are variant labels of each other, as calculated by the RZ-LGR, in a contention set. Only the application which prevails in the string contention resolution is able to proceed to the next stage. Other labels in the contention set, which

¹²⁶ See “Topic 35” in the SubPro PDP Final Report, pp. 173-182: <https://gnso.icann.org/sites/default/files/file/field-file-attach/final-report-newgtld-subsequent-procedures-pdp-02feb21-en.pdf#page=173>

¹²⁷ For contention issues that involve the same entity, the Staff Paper suggests that the following resolution options may be considered, with a preference to the second option: 1) When the requested variant labels are placed in a contention set for later evaluation, the applicant is notified of the contention set and has the opportunity to establish that both applications are from the same entity. 2) It may be more efficient to establish early on in the string similarity review that the variant labels are being requested by the same entity prior to reaching the contention phase. See Section 3.8.2 in the Staff Paper, p. 21: <https://www.icann.org/en/system/files/files/idn-variant-tld-recommendations-analysis-25jan19-en.pdf#page=21>

¹²⁸ Note that Final Recommendations 4.1-4.3 exclude the comparison of a blocked variant label against other blocked variant labels, so confusing similarity between the blocked variant labels of two or more applied-for primary gTLD strings will not place the variant label sets of those applied-for primary gTLD strings in a contention set.

according to the disposition values calculated by the RZ-LGR are variant labels of the prevailing applied-for gTLD string, will remain either withheld or blocked for the prevailing applicant. This approach abides by the “same entity” principle of having the same registry operator for all allocatable variant labels of a primary gTLD.

Rationale for Final Recommendation 6.2: Since the visual similarity check is conducted for the entire variant label set based on the Hybrid Model, it is logical to place the entire variant label set in a contention set if confusing similarity is found, as opposed to only the applied-for primary gTLD strings and applied-for allocatable variant labels.

E4 Public Comment Review:

Final Recommendation 6.1: Several commenters supported this recommendation as written.

Final Recommendation 6.2: The EPDP Team considered a comment received, and agreed to replace the original phrase “processed in the contention set” in the recommendation language with “placed in a contention set” to clarify the intent.

4.7 Contractual Requirements

D1a Charter Question:

A TLD is subject to a Registry Agreement with ICANN. In case of IDN variant TLDs, ICANN would execute the Registry Agreement with the same entity but potentially diverge in future Registry Agreement amendments, addendums, and renewals. Should each TLD label be the subject of a separate Registry Agreement with ICANN?¹²⁹ If not, should each TLD label along with its variant labels be subject to one Registry Agreement with the same entity? Rationale for such definition must be clearly stated along with the answer, including goals and motivations.

D1a Final Recommendations:

Final Recommendation 7.1: Any future gTLD along with its variant labels (if any) must be subject to one Registry Agreement with each variant label having the same service level agreements (SLAs) and other operational requirements.

Implementation Guidance 7.2: A new specification or an amendment to the Base Registry Agreement for any future gTLD along with its variant label(s) may need to be developed to incorporate variant management provisions.

Final Recommendation 7.3: Any existing registry operator that is successful in its future application for its variant label(s) must be required to adopt contractual terms to accommodate the newly approved variant label(s) by way of a new Specification to its existing Registry Agreement.

D1a Rationale for Final Recommendations:

Rationale for Final Recommendation 7.1 and Implementation Guidance 7.2: The EPDP Team developed this recommendation, in part, to maintain the “same entity” principle. gTLDs and their variant labels are expected to behave as a set throughout their lifecycle and a single Registry Agreement is one of the important vehicles to keep the variant label set together. The EPDP Team agreed that it is efficient and logical to have a future primary gTLD and its approved variant labels subject to one Registry Agreement with one registry operator. Each approved label from the variant label set, as authorized by ICANN, must be subject to the same base terms and conditions of the one Registry Agreement, with each variant label having the same service level agreements (SLAs) and other operational requirements.

The EPDP Team understood that an updated Base Registry Agreement for future rounds will be developed during implementation of the SubPro PDP Outputs. Therefore, the EPDP Team

¹²⁹ Based on the premise that a gTLD variant label is a gTLD label with its status indistinguishable from any other gTLD label in the root zone, the Staff Paper recommends that each gTLD variant label would be the subject of a separate Registry Agreement with ICANN, as each gTLD variant label is, in effect, a gTLD. See Section 3.6 in the Staff Paper, p.15: <https://www.icann.org/en/system/files/files/idn-variant-tld-recommendations-analysis-25jan19-en.pdf#page=15>

suggested that the relationship between a future gTLD and its variant label(s) can be contained in a special provision of the updated Registry Agreement. A practical solution for consideration may be developing a new specification or an amendment to the Base Registry Agreement. This new specification or amendment can specifically incorporate variant management provisions, including but not limited to the contractual requirements regarding the “same entity” principle in accordance with Final Recommendations 7.6-7.7.

Rationale for Final Recommendation 7.3: The EPDP Team learned from ICANN org that the current Base Registry Agreement from 2017 may be insufficient in form and substance to address variant management at the top-level, as gTLD variant labels have never been permitted.¹³⁰ The EPDP Team also understood that updating the Base Registry Agreement for existing registry operators from the 2012 round is subject to the global amendment process. That process is limited in frequency and must be accepted by the registry operators per the applicable thresholds. Currently, there are no existing rules, processes, or procedures for allowing individual registry operators to move between base versions of the Registry Agreement. The EPDP Team also noted that not all existing registry operators are on the same version of the Registry Agreement.

Taking into account the operational input from ICANN org, the EPDP Team agreed that it may be more expedient to require any existing gTLD registry operator that is successful in its future application for variant label(s) to adopt contractual terms to accommodate the newly approved variant labels by way of a new Specification to its existing Registry Agreement. The details of the Specification should be determined during implementation. At the time this recommendation was developed, it was envisioned that only existing IDN gTLDs delegated as a result of the 2012 round would be impacted, based on the RZ-LGR version 5 calculation.

This approach will maintain consistency with Final Recommendation 7.1 and Implementation Guidance 7.2, as well as ensure uniformity in the use of Registry Agreement by all registry operators, including both existing and future registry operators that manage gTLD variant labels. It will also adhere to SubPro PDP Affirmation 36.2 which supports the “current practice of maintaining a single base Registry Agreement with ‘Specifications’”.¹³¹

D1a Public Comment Review:

Wording Change: Final Recommendation 7.1 and Implementation Guidance 7.2 incorporated the suggested wording change raised in Public Comment, as explained in the Public Comment Review section for Final Recommendations 1.1-2.1:

- Use “existing” when referring to all of the gTLDs that have been delegated in the root zone.

¹³⁰ In November 2022, ICANN org provided input from operational perspectives for a subset of draft recommendations that were considered stable: <https://mm.icann.org/pipermail/gnso-epdp-idn-team/attachments/20221116/c1e0a14b/IDNEPDPICANNOrgInput-16Nov22-0001.pdf>. See details pertaining to ICANN org input for this topic on pp.9-10.

¹³¹ See Affirmation 36.2 in the SubPro PDP Final Report, p.183: <https://gnso.icann.org/sites/default/files/file/field-file-attach/final-report-newgtld-subsequent-procedures-pdp-02feb21-en.pdf#page=183>

- Refrain from mentioning “2012 round” in the recommendation language when referring to the existing gTLDs, as this may be perceived as limiting and can potentially cause misinterpretation.
- Remove the mention of “IDN” in order to future-proof potential updates to the RZ-LGR, in the event that allocatable variant labels are created from ASCII code points.
- Add clarification in the rationale that at the time the recommendation was developed, it was envisaged that only existing IDN gTLDs delegated as a result of the 2012 round would be impacted by [Final Recommendation 7.3](#), based on the RZ-LGR version 5 calculation.

Final Recommendation 7.1: The EPDP Team agreed to accept a suggestion raised in Public Comment to add the requirement that each variant label will have the same SLAs and other operational requirements as the primary gTLD.

Final Recommendation 7.3: The EPDP Team discussed the concerns raised by some commenters regarding the preliminary recommendation which requires existing registry operators to enter into a separate, new Registry Agreement for the newly approved variant label(s). Based on the comments, the EPDP Team reconsidered this recommendation in conjunction with [Final Recommendation 7.1](#), concluding that the different approaches would create complexity for implementation. Consequently, the EPDP Team revised this recommendation to similarly require a new Specification be added to an existing Registry Agreement in order accommodate the newly approved variant label(s) of an existing gTLD.

D1b Charter Question:

What should be the process by which an existing registry operator could apply for, or be allocated, a variant for its existing gTLD? What should be the process by which an applicant applying for a new IDN gTLD could seek and obtain any allocatable variant(s)? What should be the associated fee(s), including the application fees and annual registration fees for variant TLDs? Should any specific implementation guidance be provided?¹³²

D1b Final Recommendations:

Final Recommendation 7.4: The registry fixed fee for a gTLD registry operator that operates the delegated gTLD label(s) from a variant label set must be the same as a gTLD registry operator of a single gTLD.

¹³² SubPro PDP did not have substantive discussion about this question. Some SubPro PDP members believe that allocatable variant labels gTLDs should be made available to IDN gTLD registry operators and applicants, with only limited procedures and costs in place. As these deliberations arose late in the SubPro PDP’s life cycle, the group elected to only recommend the “same entity” principle for gTLD variant labels but refrained from providing recommendations on how gTLD variant labels can be obtained. However, SubPro includes in its recommendation that the “same entity” policy for the top-level must be captured in the relevant Registry Agreement. See Rationale for Recommendation 25.5 in the SubPro PDP Final Report, p.117: <https://gnso.icann.org/sites/default/files/file/field-file-attach/final-report-newgtld-subsequent-procedures-pdp-02feb21-en.pdf#page=117> and Recommendation 25.5 in the SubPro PDP Final Report, p.115: <https://gnso.icann.org/sites/default/files/file/field-file-attach/final-report-newgtld-subsequent-procedures-pdp-02feb21-en.pdf#page=115>

Final Recommendation 7.5: The calculation of the registry-level transaction fee must be based on the cumulative number of domain name registrations of the combined delegated gTLD label(s) from a variant label set.

D1b Rationale for Final Recommendations:

Rationale for Final Recommendation 7.4: The EPDP Team noted that Article 6, Section 6.1 of the Base Registry Agreement specifies that a registry operator shall pay ICANN the registry fixed fee of US\$6,250 per calendar quarter.¹³³ Following the “same entity” principle that has been consistently reflected in several EPDP Team recommendations, including Final Recommendation 7.1 that requires a future gTLD and its variant label(s) to be subject to one Registry Agreement, the EPDP Team agreed that the registry fixed fee must cover both the delegated primary gTLD and its variant label(s). In other words, one registry fixed fee must cover all of the delegated gTLD label(s) from a variant label set. The EPDP Team also noted that the registry fixed fee is already substantial; requiring the registry operator to pay the registry fixed fee for each one of its delegated gTLD label(s) from a variant label set could potentially be a barrier to introducing gTLD variant labels at the top-level.

Rationale for Final Recommendation 7.5: The EPDP Team noted that Article 6, Section 6.1 of the Base Registry Agreement also specifies that a registry operator shall pay ICANN the registry-level transaction fee of US\$0.25 per calendar quarter for each domain name registration.¹³⁴ The registry-level transaction fee shall not apply until and unless more than 50,000 registrations have occurred in the gTLD during any calendar quarter or any consecutive four calendar quarter periods in the aggregate.

Following the “same entity” principle and given that all delegated gTLD variant label(s) from a variant label set are managed by the same registry operator, the EPDP Team agreed that the calculation of the registry-level transaction fee must be based on the cumulative number of domain name registrations of the combined delegated gTLD label(s) from a variant label set. In other words, whether the registry-level transaction fee threshold is met is determined by the cumulative number of domain name registrations of the primary gTLD and all of its delegated variant label(s), rather than by the number of domain name registrations of each delegated gTLD from the variant label set.

By way of example, during a calendar quarter, if there are 25,000 domain name registrations of primary gTLD t1, 20,000 registrations of variant label t1v1, and 5,001 registrations of variant label t1v2, the cumulative number of domain name registrations of t1, t1v1, and t1v2 combined is 50,001, which surpasses the threshold for the registry-level transaction fee to apply.

¹³³ See Section 6.1 of the Base Registry Agreement here:

<https://newgtlds.icann.org/sites/default/files/agreements/agreement-approved-31jul17-en.pdf#page=18>

¹³⁴ Ibid.

D1b Public Comment Review:

Wording Change: Final Recommendations 7.4-7.5 incorporated the suggested wording change raised in Public Comment, as explained in the Public Comment Review section for Final Recommendation 2.1: Remove the mention of “IDN” in order to future-proof potential updates to the RZ-LGR, in the event that allocatable variant labels are created from ASCII code points.

B2 Charter Question:

Both the SubPro PDP and the Staff Paper recommend that variant TLDs be operated by the same back-end registry service provider, the organization providing one or more registry services (e.g., DNS, DNSSEC, RDDS, EPP) for a registry operator. Should this recommendation be extended to existing TLDs and their variant TLD labels?

B2 Final Recommendations:

Final Recommendation 7.6: The registry service provider for each one of the Critical Functions as defined in the Base Registry Agreement for an existing gTLD must be the same as for its delegated variant labels. The Critical Functions are: DNS Service, DNSSEC proper resolution, EPP, RDDS, and Data Escrow.¹³⁵

Final Recommendation 7.7: If the registry operator changes its gTLD’s registry service provider for any one of the Critical Functions, the variant label(s) of that gTLD must simultaneously transition to the same registry service provider for that Critical Function.

B2 Rationale for Final Recommendations:

Rationale for Final Recommendations 7.6-7.7: For feasible and consistent implementation of the “same entity” requirement at the top-level, the EPDP Team extends the SubPro PDP Recommendation 25.5 and the Staff Paper Recommendation 7 to existing gTLDs and their variant labels.¹³⁶ At the time the recommendation was developed, it was envisaged that only existing IDN gTLDs delegated as a result of the 2012 round would be impacted by Final Recommendation 7.6, based on the calculation of RZ-LGR version 5.

Registry operators may use different third-party service providers for the provision of their Critical Functions. In the event that an existing gTLD registry operator applies for variant labels of its gTLD in the future, it will be required to use the same registry service provider for the provision of its respective Critical Functions. For example, its Data Escrow provider must be the

¹³⁵ See details in Section 6 of Specification 10 in the Base Registry Agreement:

<https://newgtlds.icann.org/sites/default/files/agreements/agreement-approved-31jul17-en.html#specification10>

¹³⁶ See Recommendation 25.5 in the SubPro PDP Final Report, p.115:

<https://gns0.icann.org/sites/default/files/file/field-file-attach/final-report-newgtld-subsequent-procedures-pdp-02feb21-en.pdf#page=115>; Recommendation 7 in the Staff Paper, p.4:

<https://www.icann.org/en/system/files/files/idn-variant-tld-recommendations-analysis-25jan19-en.pdf#page=4>

same for the existing gTLD and the delegated variant labels; its DNS service provider must also be the same for its existing gTLD and the delegated variant labels.

The EPDP Team further recommends that the same registry service provider must operate all delegated gTLD label(s) from the variant label set at any given time. To that end, the transition to a new registry service provider must apply to the gTLD and all of its delegated variant label(s) at the same time.

B2 Public Comment Review:

Wording Change: Final Recommendations 7.6-7.7 incorporated the suggested wording change raised in Public Comment, as explained in the Public Comment Review section for Final Recommendations 1.1-2.1:

- Use “existing” when referring to all of the gTLDs that have been delegated in the root zone.
- Refrain from mentioning “2012 round” in the recommendation language when referring to the existing gTLDs, as this may be perceived as limiting and can potentially cause misinterpretation.
- Remove the mention of “IDN” in order to future-proof potential updates to the RZ-LGR, in the event that allocatable variant labels are created from ASCII code points.
- Add clarification in the rationale of Final Recommendation 7.6 that at the time the recommendation was developed, it was envisaged that only existing IDN gTLDs delegated as a result of the 2012 round would be impacted, based on the RZ-LGR calculation.

Final Recommendations 7.6-7.7: The EPDP Team agreed with a suggestion raised in Public Comment to also mention “Critical Functions” in the recommendation language in order to resolve any semantic inconsistencies with Final Recommendation 7.6 and minimize potential for misinterpretation.

There was a concern raised in Public Comment that several EPDP-IDNs recommendations (including these recommendations) may not be worded in accordance with internationally recognized data protection principles. The EPDP Team recognized that this comment is out of scope. The EPDP Team also acknowledges that contracted parties must comply with all applicable laws and regulations.

D2 Charter Question:

In order to ensure that the same entity principle is maintained for a gTLD and its allocated variant TLD labels, what are the operational and legal impacts to the:

- *Registry Transition Process or Change of Control in the Registry Agreement;*¹³⁷
- *Emergency Back-End Registry Operator (EBERO) provisions; and*
- *Reassignment of the TLD as a result of the Trademark Post-Delegation Dispute Resolution Procedure (TM-PDDRP);*¹³⁸

D2 Final Recommendations:

Final Recommendation 7.8: In the event a Registry Transition or Change of Control process is initiated for a gTLD, the process must encompass the gTLD and all its allocated and delegated variant label(s), if any, at the same time.

Final Recommendation 7.9: After the Registry Transition Process or Change of Control process is completed for a gTLD and its allocated and delegated variant label(s), the successor registry operator can apply for the other non-delegated, allocatable variant label(s) of that gTLD in accordance with the “same entity” principle pursuant to [Final Recommendation 2.1](#).

Final Recommendation 7.10: Emergency transition of a gTLD to an EBERO provider must include the allocated and delegated variant label(s) of that gTLD, if any. All these labels must be transitioned to the same EBERO provider at the same time.

Final Recommendation 7.11: In the event a gTLD is reassigned as a result of a TM-PDDRP determination, that reassignment must include all allocated and delegated variant label(s) of the gTLD, if any, at the same time.

¹³⁷ The Staff Paper recommends that each set of Registry Agreement(s) must contain provisions requiring all the labels in the Internationalized Domain Label (IDL) set to follow the same process in the event of any registry transition via a Registry Transition Process or Change of Control. In no event, should the composition of the allocated and delegated set of gTLD variant labels be allowed to change at the same time as the change of the Registry Operator. The SubPro PDP also agreed that to the extent that the gTLD were to change hands at any point after delegation, the gTLD variant labels must remain linked contractually, which should be considered a persistent requirement (e.g., this would impact gTLD registry transition procedures). See Section 3.6 in the Staff Paper, p.15:

<https://www.icann.org/en/system/files/files/idn-variant-tld-recommendations-analysis-25jan19-en.pdf#page=15> and Rationale for Recommendation 25.5 in the SubPro PDP Final Report, p.117: <https://gnso.icann.org/sites/default/files/file/field-file-attach/final-report-newgtld-subsequent-procedures-pdp-02feb21-en.pdf#page=117>

¹³⁸ The Staff Paper recommends that an emergency transition of a gTLD to an EBERO provider must trigger an emergency transition of all gTLD variant labels to the EBERO provider. In addition, the SubPro PDP also agreed that EBERO would be impacted due to the persistent requirement of ensuring that gTLD variant labels must remain linked contractually. See Section 3.6 in the Staff Paper, p.16: <https://www.icann.org/en/system/files/files/idn-variant-tld-recommendations-analysis-25jan19-en.pdf#page=16> and Rationale for Recommendation 25.5 in the SubPro PDP Final Report, p.117: <https://gnso.icann.org/sites/default/files/file/field-file-attach/final-report-newgtld-subsequent-procedures-pdp-02feb21-en.pdf#page=117>. In the case where a Registry Agreement is terminated as a result of a TM-PDDRP determination, this would trigger the Registry Transition Procedure and various outcomes could apply. The Staff Paper notes that in the case of a reassignment of the gTLD, the “same entity” rule should continue to apply so that the gTLD variant labels would be assigned to the same entity together. See Section 3.7 in the Staff Paper, p.18: <https://www.icann.org/en/system/files/files/idn-variant-tld-recommendations-analysis-25jan19-en.pdf#page=18>

D2 Rationale for Final Recommendations:

Rationale for Final Recommendations 7.8-7.11: The EPDP Team agreed with the rationale for SubPro PDP Recommendation 25.5 that “to the extent that the TLD were to change hands at any point after delegation, the variant TLDs must remain linked contractually, which should be considered a persistent requirement (e.g., this would impact gTLD registry transition procedures, including EBERO).”¹³⁹ To that end, the EPDP Team recommends that any future gTLD along with its variant label(s) (if any) will be subject to one Registry Agreement (see [Final Recommendation 7.1](#)). Furthermore, in the event of the registry transition – including emergency back-end registry operator temporary transition process and the reassignment of a gTLD as an outcome of a Trademark Post-Delegation Dispute Resolution Procedure (TM-PDDRP) determination – the EPDP Team recommends that a gTLD and all of its allocated and delegated variant label(s) must be included in the same process and transition to the same entity at the same time.

D2 Public Comment Review:

Wording Change: Final Recommendations 7.8-7.11 incorporated the suggested wording change raised in Public Comment, as explained in the Public Comment Review section for [Final Recommendation 2.1](#): Remove the mention of “IDN” in order to future-proof potential updates to the RZ-LGR, in the event that allocatable variant labels are created from ASCII code points.

Final Recommendations 7.8 and 7.11: There was a concern raised in Public Comment that several EPDP-IDNs recommendations (including these recommendations) may not be worded in accordance with internationally recognized data protection principles. The EPDP Team recognized that this comment is out of scope. The EPDP Team also acknowledges that contracted parties must comply with all applicable laws and regulations.

Final Recommendation 7.9: The EPDP Team agreed with a suggestion raised in Public Comment to incorporate the “same entity” principle in the recommendation language, but disagreed with the suggestion of removing the term “successor”.

D3 Charter Question:

*In order to ensure that the same entity principle is maintained, what are the operational and legal impacts to the data escrow policies, if any.*¹⁴⁰

¹³⁹ See Rationale for Recommendation 25.5 in the SubPro Final Report, p.115:

<https://gnso.icann.org/sites/default/files/file/field-file-attach/final-report-newgtld-subsequent-procedures-pdp-02feb21-en.pdf#page=115>

¹⁴⁰ Data escrow is the act of storing data with a neutral third party in case of registry or registrar failure, accreditation termination, or accreditation relapse without renewal. ICANN requires all registrars and gTLD registries to contract with a data escrow provider in order to safeguard registrants. Because each variant label of the IDL set is just another registration, data escrow policies for TLDs apply individually to each. The Staff Paper notes that the data escrow requirements are automatically satisfied for gTLD variant labels. See Section 3.9.2 in the Staff Paper, p.22:

<https://www.icann.org/en/system/files/files/idn-variant-tld-recommendations-analysis-25jan19-en.pdf#page=22>

D3 Final Recommendations:

Final Recommendation 7.12: The same data escrow provider must be contracted for the gTLD and its allocated and delegated variant label(s).

Implementation Guidance 7.13: The escrow data associated with each gTLD variant label should be stored in separate files.

D3 Rationale for Final Recommendations:

Rationale for Final Recommendation 7.12 and Implementation Guidance 7.13: The EPDP Team agreed that the current practice with regard to data escrow requirements must be maintained for gTLDs and their allocated and delegated variant labels in order to maintain the stability of the associated domain name registrations. To facilitate the implementation of data escrow requirements in a consistent manner, the same data escrow provider must be contracted for the gTLD and its allocated and delegated variant label(s), which are subject to one Registry Agreement. Nevertheless, the escrow data associated with each variant label should be stored in separate files, as each variant label from the variant label set is an individual registration from a technical perspective.

The EPDP Team noted a suggestion from Public Comment to develop an implementation guidance, explicitly stating that each delegated variant label should be treated as a distinct gTLD in the business-to-business interactions related to the Registry Agreement. The EPDP Team agreed with this notion, but did not believe a separate implementation guidance was necessary. Its [Implementation Guidance 7.13](#) is already consistent with this notion, recognizing each gTLD variant label as a distinct identifier for data escrow purposes.

D3 Public Comment Review:

Wording Change: [Final Recommendation 7.12](#) incorporated the suggested wording change raised in Public Comment, as explained in the Public Comment Review section for [Final Recommendation 2.1](#): Remove the mention of “IDN” in order to future-proof potential updates to the RZ-LGR, in the event that allocatable variant labels are created from ASCII code points.

Final Recommendation 7.12: There was a concern raised in Public Comment that several EPDP-IDNs recommendations (including this recommendation) may not be worded in accordance with internationally recognized data protection principles. The EPDP Team recognized that this comment is out of scope. The EPDP Team also acknowledges that contracted parties must comply with all applicable laws and regulations.

Implementation Guidance 7.13: The EPDP Team noted a suggestion from Public Comment to explicitly state that each delegated variant label should be treated as a distinct gTLD in the business-to-business interactions related to the Registry Agreement. The EPDP Team agreed with this notion, but did not believe it was necessary. [Implementation Guidance 7.13](#) is already consistent with this notion, recognizing each gTLD variant label as a distinct identifier for data escrow purposes.

B5 Charter Question:

Do restrictions that apply to a TLD (e.g., community TLDs, dot brand TLDs) also apply to its variants? Are these labels equally treated as different versions of the same string, or completely independent strings not bound by the same restrictions?

B5 Final Recommendations:

Final Recommendation 7.14: The applied-for primary gTLD string and any allocatable variant label sought by the applicant must be bound by the same restrictions, which will become contractual requirements upon execution of the Registry Agreement. Similarly, any allocatable variant label sought by an existing registry operator will be bound by the same restrictions as the existing gTLD upon execution of the new Specification to its existing Registry Agreement for the newly approved variant label(s). The restrictions in this recommendation refer to the differential treatment and requirements applied to non-standard types of gTLDs, which are Community-based TLDs, Brand TLDs, Geographic Name TLDs, as well as TLDs subject to Category 1 Safeguards.¹⁴¹

B5 Rationale for Final Recommendations:

Rationale for Final Recommendation 7.14: The EPDP Team discussed this charter question in the context of new gTLD applications for the non-standard types of gTLDs that have differential treatment and requirements, such as different application questions, evaluation processes, contractual requirements, and post-delegation activities. Those non-standard types of gTLDs are Community-based TLDs, Brand TLDs, Geographic Name TLDs, and TLDs subject to Category 1 Safeguards, which have been reaffirmed by the SubPro PDP. The EPDP Team agreed that restrictions applied to the primary gTLD will also apply to any applied-for allocatable variant labels upon execution of the corresponding Registry Agreement. In other words, if an applied-for primary gTLD string is a Brand TLD, any allocatable variant labels sought by the applicant will also be treated as a Brand TLD and be bound by the same restrictions, which will become contractual requirements upon execution of the corresponding Registry Agreement. The EPDP Team further agreed that the same recommendation extends to any applied-for allocatable variant label(s) sought by an existing registry operator.

B5 Public Comment Review:

Wording Change: Final Recommendation 7.14 incorporated the suggested wording change raised in Public Comment, as explained in the Public Comment Review section for [Final Recommendations 1.1-2.1](#):

¹⁴¹ SubPro PDP identified only three categories of gTLDs that have non-standard application types. In addition, SubPro PDP identified the TLDs subject to Category 1 Safeguards as a non-standard string type, as such strings must adopt relevant Category 1 Safeguards as contractually binding requirements in Specification 11 (mandatory Public Interest Commitments) of the Registry Agreement. See Recommendation 4.1 in SubPro PDP Final Report, pp.24-27: <https://gnso.icann.org/sites/default/files/file/field-file-attach/final-report-newgtld-subsequent-procedures-pdp-02feb21-en.pdf#page=24>

- Use “existing” when referring to all of the gTLDs that have been delegated in the root zone.
- Refrain from mentioning “2012 round” in the recommendation language when referring to the existing gTLDs, as this may be perceived as limiting and can potentially cause misinterpretation.
- Remove the mention of “IDN” in order to future-proof potential updates to the RZ-LGR, in the event that allocatable variant labels are created from ASCII code points.

Final Recommendation 7.14: As a result of Public Comment review, this recommendation was amended to refer to a new Specification being added to an existing Registry Agreement to accommodate the newly approved variant label(s) of an existing gTLD.

4.8 Delegation and Removal

A5 Charter Question:

SAC060 notes that variant code points in LGR may introduce a “permutation issue”, possibly creating a large number of variant domain names, which “presents challenges for the management of variant domains at the registry, the registrar and registrant levels.”¹⁴² SAC060 advises that “ICANN should ensure that the number of strings that are activated is as small as possible.” The TSG agreed with this SSAC advice.¹⁴³ Appendix C of the Staff Paper reviewed the factors causing numerous variant labels and suggested measures to address this issue.¹⁴⁴

Should there be a ceiling value or other mechanism to ensure that the number of delegated top-level variant labels remains small, understanding that variant labels in the second level may compound the situation? Should additional security and stability guidelines be developed to make variant domains manageable at the registry, registrar, and registrant levels?¹⁴⁵

A5 Final Recommendations:

Final Recommendation 8.1: No ceiling value for delegated top-level variant labels from a variant label set is necessary as existing measures in the RZ-LGR to reduce the number of allocatable top-level variant labels, as well as economic, operational, and other factors that may impact the decision to apply for variant labels, will keep the number of delegated top-level variant labels conservative.

Final Recommendation 8.2: In order to encourage a positive and predictable registrant experience, ICANN org must, during implementation, create a framework for developing non-binding guidelines for the management of gTLDs and their variant labels at the top-level by registries and registrars.

Implementation Guidance 8.3: The framework should outline the scope and the steps involved in developing future non-binding guidelines, which at a minimum should involve relevant stakeholders, such as registries, registrars, and where feasible, registrants who have experience with IDNs and variant labels.

¹⁴² See Recommendation 14, SAC060, p. 20: <https://www.icann.org/en/system/files/files/sac-060-en.pdf#page=20>

¹⁴³ See Recommendation 6 in the TSG report, p.7: <https://www.icann.org/en/system/files/files/rz-lgr-technical-utilization-recs-07oct19-en.pdf#page=7>

¹⁴⁴ See Appendix C of the IDN Variant TLD Implementation: Appendices, pp. 12-29:

<https://www.icann.org/en/system/files/files/idn-variant-tld-appendices-25jan19-en.pdf#page=12>

¹⁴⁵ One of the security and stability concerns is that some scripts can generate large numbers of variant labels based on the way the LGR works. The RZ-LGR Procedure manages such numbers by minimizing allocatable variant labels and maximizing blocked variant labels. However, though this approach is optimal in most cases, the outcome may be worse for a specific label in some cases.

A5 Rationale for Final Recommendations:

Rationale for Final Recommendation 8.1: The EPDP Team had considerable discussion on this topic. This included engagement with members of the SSAC to better understand SSAC advice (SAC060) relevant to this topic, as well as consideration of an analysis prepared by ICANN Org of the treatment of variant labels in the RZ-LGR. This recommendation was subsequently developed based on the following understanding:

- Of the 26 scripts already integrated in the RZ-LGR version 5, four scripts have no variant labels and 15 scripts have no allocatable variant labels. Only seven scripts have allocatable variant labels, namely: Arabic, Bengali, Chinese, Greek, Latin, Myanmar, and Tamil. Except for Arabic, the language communities of the other six scripts have already limited the number of allocatable variant labels (i.e., one to four variant labels of the primary label are allocatable).¹⁴⁶
- Notwithstanding the prevailing measures contained in the RZ-LGR, existing registries and future gTLD applicants should not have arbitrary limits placed on the number of gTLD variant labels for which they wish to apply. The EPDP Team considered that there will be a number of factors that the existing registries and future applicants will take into consideration that will likely result in a conservative approach to applying for variant labels, such as cost, operational competence, and potential challenges associated with managing a gTLD and its variant labels at the registry, registrar and registrant levels.
- SAC060 recommends applying a conservative approach in order to avoid the potential permutation issues of variant labels both at the top-level and with combinations of the top-level and the second-level. However, SSAC members confirmed, during an engagement session with the EPDP Team, that the sheer volume of variant labels does not necessarily create security or stability risks, as a gTLD and its variant labels appear as separate gTLDs in the root zone. The concern expressed by the SSAC members was associated with the lack of a DNS protocol solution that enforces equivalence of variant labels and the challenges of creating a consistent experience for the end user of the gTLD and its variant labels.¹⁴⁷

Rationale for Final Recommendation 8.2 and Implementation Guidance 8.3: The EPDP Team agreed that it would be valuable to develop non-binding guidelines for the management of gTLDs and their variant labels at the top-level by registries and registrars. This is to address any unintended consequences of Final Recommendation 8.1, as well as to address the concern raised by SSAC members that the lack of a common approach by registries and registrars in

¹⁴⁶ ICANN org staff checked all scripts in the RZ-LGR version 5, which was the version available when the EPDP Team deliberated on Recommendation 1.4, and those incorporated in the next version (i.e., RZ-LGR version 5) to see if there are mechanisms in place to reduce the number of allocatable variant labels. For the scripts with allocatable variant labels, ICANN org staff ran all existing gTLDs in those scripts through the RZ-LGR to see how many variant labels are created. The findings were presented during the EPDP Team meeting on 20 January 2022. See slides here: <https://community.icann.org/download/attachments/183992731/EPDP%20on%20IDNs%20-%20A5%20-%2020%20Jan%202022.pdf?version=1&modificationDate=1642693642936&api=v2>

¹⁴⁷ On 13 January 2022, the IDNs EPDP Team engaged with SSAC members to discuss their early input to the IDNs EPDP as well as specific questions related to the charter questions. See details here: <https://community.icann.org/x/iYH3Cg>. See SAC060 here: <https://www.icann.org/en/system/files/files/sac-060-en.pdf>

managing gTLDs and their variant labels may result in a less than optimal experience for registrants.

The EPDP Team agreed that ICANN org must create the framework for developing the guidelines during implementation, and the framework be subject to public comment as part of the policy implementation process. The main purpose of the framework is to clarify the scope and outline the steps involved in developing the guidelines for the operation of gTLDs and their variant labels by registries and registrars. The EPDP Team acknowledged that because gTLD variant labels are currently not allowed, it will be hard to fully understand the user experience until they are delegated. As such, actual guidelines are expected to be developed after a number of gTLD variant labels have been delegated. Consequently, the framework could also include provisions for potential research or case studies of user experiences related to gTLD variant labels. The EPDP Team also agreed that the future guidelines should be developed with the help of relevant stakeholders, such as registries, registrars, and where feasible, registrants that have experience in IDNs and variant labels. The EPDP Team agreed that ICANN org will be responsible for deciding how to disseminate the non-binding guidelines in the future.

A5 Public Comment Review:

Final Recommendation 8.1: The EPDP Team noted that this recommendation, as well as the closely related Final Recommendations 3.11-3.12 received strong support from many commenters. The EPDP Team had extensive discussion about the concerns raised by some commenters regarding this recommendation, in conjunction with Final Recommendations 3.11-3.12. They understood that those commenters were concerned about what they perceived to be a less than conservative approach of not setting a ceiling for the number of allocatable variant labels that can be delegated for any one primary gTLD string, as well as charging the base application fee for an application that includes up to four (4) allocatable variant labels plus the primary gTLD string from a variant label set. Notwithstanding, there was overwhelming support from the EPDP Team for not setting an arbitrary ceiling and not changing the threshold number. The Team believes that the more arbitrary constraints are placed on gTLD variant label applications, the more difficult it would be for encouraging the introduction of gTLD variant labels and promoting IDN registrations that help build a multilingual Internet. The EPDP Team agreed to enhance Final Recommendation 3.5 and Implementation Guidance 3.6 and 3.9 regarding the evaluation of gTLD variant label applications in order to align with the conservatism principle.

Final Recommendation 8.2 and Implementation Guidance 8.3: The EPDP Team agreed with a suggestion raised in Public Comment to add “non-binding” before guidelines to confirm its nature. In response to questions raised in Public Comment, the EPDP Team clarified that it is ICANN org’s responsibility for creating the framework for developing such guidelines, and it is at ICANN org’s discretion how to disseminate the guidelines in the future. In addition, the EPDP Team confirmed that the proposed framework is subject to public comment as part of the policy implementation process.

B4 Charter Question:

The policy recommendation advises that variant TLD labels be allocated to the same entity, however a process to apply for a variant TLD does not exist. The WG and the SubPro IRT to coordinate and consider the following questions in order to develop a consistent solution: what should an application process look like in terms of timing and sequence for an existing and future Registry Operator with respect to applying or activating their allocatable variant TLD labels?

B4 Final Recommendations:

Final Recommendation 8.4: Applicants for a primary gTLD string and its applied-for allocatable variant label(s) that pass evaluation must be subject to the terms and conditions, as recommended by the SubPro PDP, in respect of the timeframe for delegation, including the ability to apply for an extension of time for delegation.

Final Recommendation 8.5: The sequence for delegating the applied-for primary gTLD string and the applied-for allocatable variant label(s) that pass evaluation should be determined by the registry operator.

B4 Rationale for Final Recommendations:

Rationale for Final Recommendations 8.4-8.5: SubPro PDP supports maintaining the gTLD delegation timeframe set forth in the 2012 Applicant Guidebook and Base Registry Agreement; namely that registry operators must complete all testing procedures for delegating the gTLD into the root zone within twelve (12) months of the Effective Date of the Registry Agreement. In addition, SubPro PDP affirmed that registry operators may request an extension of up to twelve (12) additional months for delegation.¹⁴⁸

The EPDP Team agreed with the SubPro PDP recommendations which require each applied-for primary gTLD string and its applied-for allocatable variant label(s) that pass evaluation be delegated within the said twelve (12) month timeframe, subject to the possibility of an extension of up to twelve (12) additional months. This is on the understanding that the delegation of each applied-for primary gTLD string and its applied-for allocatable variant label(s) will be delegated at or about the same time to ensure the best user experience. Per [Final Recommendation 7.1](#), wherein a primary gTLD and its applied-for allocatable variant label(s) that pass evaluation will be subject to one Registry Agreement, the EPDP Team agreed that all these labels must abide by the same timeframe requirements for delegation. To do otherwise could deviate from the SubPro PDP recommendations and create excessive complexity.

The EPDP Team had extensive discussions about the order in which the primary gTLD string and its applied-for allocatable variant label(s) that pass evaluation should be delegated. In the absence of security or stability issues, and considering the fact that all these labels are regarded as individual gTLDs in the root zone, the EPDP Team agreed that this issue does not need to be

¹⁴⁸ See Affirmation 40.1 and Affirmation 40.2 in the SubPro PDP Final Report, p.191:

<https://gnso.icann.org/sites/default/files/file/field-file-attach/final-report-newgtld-subsequent-procedures-pdp-02feb21-en.pdf#page=191>

mandated by policy and should be at the discretion of registry operators according to their respective business interests and needs as stated in their applications. However, all labels must be delegated within the required timeframe or any extended timeframe granted by ICANN org to the registry operator.¹⁴⁹

B4 Public Comment Review:

Wording Change: Final Recommendations 8.4-8.5 incorporated the suggested wording change raised in Public Comment, as explained in the Public Comment Review section for [Final Recommendation 2.1](#): Remove the mention of “IDN” in order to future-proof potential updates to the RZ-LGR, in the event that allocatable variant labels are created from ASCII code points.

Final Recommendation 8.5: The EPDP Team considered a suggestion raised in Public Comment and agreed to use “should” in the recommendation language, to align with the terminology usage as described in RFC 2119.

A6 Charter Question:

Since RZ-LGR can be updated over time, the WG needs to consider the implications for existing TLD labels and their variant labels (if any), including any potential changing of status or disposition value.¹⁵⁰

The TSG further recommends that the Generation Panel (GP) must call out the exception where an existing TLD is not validated by their proposed solution during the public comment period and explain the analysis and reasons for not supporting the existing TLD in their script LGR proposal.¹⁵¹ This will allow the community and the GP to review such a case to confirm that an exception is indeed warranted.

Does the WG agree with TSG’s suggested approach? If so, to what extent should the TLD policies and procedures be updated to allow an existing TLD and its variants (if any), which are not validated by a script LGR, to be grandfathered? If not, what is the recommended approach to address changes to the current version of the RZ-LGR that assign different disposition values to existing TLDs? Consider this question by taking into account the data to be collected in the “Data and Metric Requirements” section of this charter.

¹⁴⁹ During the EPDP Team meeting #58 on 17 November 22, the team discussed an example where a variant label may be delegated before the primary IDN gTLD. The label “.straße” is applied for as the primary IDN gTLD and its allocatable variant label “.strasse” is also applied for; both labels pass evaluation. The EPDP Team noted that if “.strasse” is applied for as the primary gTLD string, “.straße” cannot be applied for as it will be a blocked variant label due to the RZ-LGR calculation; such asymmetric relationship between variant labels exist in several scripts, such as Arabic, Greek, Latin, and Myanmar. The registry operator decides to delegate “.strasse” first as it is an ASCII label that can readily cater to the international market, and wait to delegate “.straße” as it is an IDN string. For more details, check the notes and recordings here: <https://community.icann.org/x/NYYFDQ>

¹⁵⁰ See Recommendation 7 in the TSG report, p.8: <https://www.icann.org/en/system/files/files/rz-lgr-technical-utilization-recs-07oct19-en.pdf#page=8>

¹⁵¹ See Recommendation 12 in the TSG report, p.9: <https://www.icann.org/en/system/files/files/rz-lgr-technical-utilization-recs-07oct19-en.pdf#page=9>

A6 Final Recommendations:

Final Recommendation 8.6: Any delegated gTLDs and their delegated and allocated variant labels (if any) not validated by a proposed RZ-LGR update must be grandfathered. In other words, the proposed update will apply to future new gTLDs and their variant labels and will not be retroactive; there will be no change to the contractual and delegation state of the delegated gTLDs and their delegated and allocated variant labels (if any), which predate the proposed RZ-LGR update and are subject to the version of RZ-LGR when those gTLDs and variant labels were initially applied for upon the finalization of the application process.

Final Recommendation 8.7: For all future versions of the RZ-LGR, Generation Panels (GPs) and the Integration Panel (IP) should follow the stability principle in the LGR Procedure and make best efforts to retain full backward compatibility with delegated gTLDs and their delegated and allocated variant labels (if any).¹⁵² The LGR Procedure must be updated to specify the exceptional circumstances, to the extent known to the GPs and IP, that could result in a proposed update to the RZ-LGR not being able to retain full backward compatibility.

Final Recommendation 8.8: In the unexpected event where a proposed update to the RZ-LGR is unable to retain full backward compatibility for validating any delegated gTLDs as well as their delegated and allocated variant labels (if any), the relevant GP must call out the exception during a Public Comment period and explain the reasons for such exception. The Public Comment period should also include the elements in the following Implementation Guidance.

Implementation Guidance 8.9: The GP explanation should identify security and stability risks (if any), as well as possible actions to mitigate the risks associated with allowing a delegated gTLD and its delegated and allocated variant labels (if any) to be grandfathered. There should also be an assessment, conducted by ICANN org, of the potential impact of grandfathering on registries, registrars, registrants, and end-users, as well as proposed measures to reduce the negative impact. As part of the assessment, ICANN org should facilitate a timely dialogue between the registry operator of the grandfathered gTLD, relevant function(s) in ICANN org, the GP, other experts and affected parties.

Notwithstanding the recommendation to grandfather affected gTLDs, in the event security and stability risks are identified, ICANN org and the affected registry operator should discuss possible measures to minimize the risks that would result in minimal disruption to registries, registrars, registrants, and end-users.

¹⁵² RZ-LGR relies on the Stability principle (pg. 12) of the LGR Procedure: “Once a code point is permitted, it is almost impossible to stop permitting it: the act of permitting a code point cannot be undone. This is particularly true once a label containing this code point has been registered.” <https://www.icann.org/en/system/files/files/lgr-procedure-20mar13-en.pdf> This is repertoire stability policy concerning the RZ-LGR. This does not guarantee 100% stability, to allow fixes in case of errors for example. Any change proposed by the Generation Panel must be reviewed and approved by the Integration Panel, which holds a conservative approach and only approves changes if they pass an extremely high bar.

A6 Rationale for Final Recommendations:

Rationale for Final Recommendations 8.6-8.8: The EPDP Team developed these recommendations based on the understanding that the goal of all future updates of the RZ-LGR is to retain full backward compatibility with delegated gTLDs and their delegated and allocated variant labels (if any) to maintain the stability in the root zone. While the possibility does exist that future RZ-LGR updates may be unable to achieve full backward compatibility, the actual probability of this occurring is considered extremely low, as there are stability principles and safeguards built into the LGR Procedure.¹⁵³ Nevertheless, the EPDP Team seeks affirmation from the Generation Panels (GPs) and Integration Panel (IP) that they must make best efforts to retain full backward compatibility for all future versions of the RZ-LGR.

The EPDP Team understood that ICANN org cannot force GPs and IP to comply with PDP recommendations as they operate based on their existing process and procedures, including coordination with local communities and inclusion of additional experts to their panels, as needed. Therefore, EPDP Team requests ICANN org to share this set of recommendations, including Implementation Guidance 8.9, with GPs and IP for their consideration.

The EPDP Team recognized that there may still be unexpected circumstances that render a delegated gTLD and its delegated and allocated variant labels (if any) invalid by a proposed RZ-LGR update, making the full backward compatibility unretainable.¹⁵⁴

Given the potentially serious consequences for and negative impact on gTLD registry operators, registrars, registrants, and end-users of such an eventuality, the EPDP Team believes that there should be predictability associated with the circumstances that could eventuate in an RZ-LGR update not being able to retain full backward compatibility. For example, changes to the

¹⁵³ There are stability clauses or mechanisms in the RZ-LGR, IDNA2008, and the Unicode base layer to ensure that existing gTLDs will be allowed to remain despite future changes.

- Unicode has a comprehensive set of stability policies: <https://www.unicode.org/versions/Unicode14.0.0/ch03.pdf> and <https://www.unicode.org/policies>. The key stability policies are that characters do not get moved/removed, and the stability of the Normalization Forms.
- IDNA 2008 relies on its use of Unicode stable function like normalization to assure stability and use the General Category property (GC) to ensure its own stability. RFC 5892 contains stability considerations in its introduction: <https://datatracker.ietf.org/doc/html/rfc5892>. Because GC is not part of the immutable set in Unicode, there is a mechanism in IDNA 2008 to allow backward compatibility to maintain stability: “Changes in Unicode properties that do not affect the outcome of this process do not affect IDN. For example, a character can have its Unicode General_Category value (see Unicode52: <https://datatracker.ietf.org/doc/html/rfc5892#ref-Unicode52>) change from So to Sm or from Lo to Ll, without affecting the algorithm results. Moreover, even if such changes were the result, the BackwardCompatible list (Section 2.7: <https://datatracker.ietf.org/doc/html/rfc5892#section-2.7>) can be adjusted to ensure the stability of the results.”
- RZ-LGR relies on the Stability principle (pg. 12) of the LGR Procedure: “Once a code point is permitted, it is almost impossible to stop permitting it: the act of permitting a code point cannot be undone. This is particularly true once a label containing this code point has been registered.” <https://www.icann.org/en/system/files/files/lgr-procedure-20mar13-en.pdf> This is repertoire stability policy concerning the RZ-LGR. This does not guarantee 100% stability, to allow fixes in case of errors for example. Any change proposed by the Generation Panel must be reviewed and approved by the Integration Panel, which holds a conservative approach and only approves changes if they pass an extremely high bar.

¹⁵⁴ One possibility may be that a code point was mistakenly permitted in a prior version of the RZ-LGR and a corresponding TLD has been delegated in the root zone. The proposed RZ-LGR update is to remove that code point in order to fix the error, hence affecting the existing TLD.

IDNA2008 or Unicode, which are outside the control of the LGR process, could be legitimate reasons for an RZ-LGR update being unable to retain backward compatibility.

To that end, the EPDP Team recommends that the LGR Procedure be updated to explicitly enumerate such exceptional circumstances to the extent known to the GPs and IP, while acknowledging that it may not be possible to identify all potential circumstances that could render full backward compatibility unretainable.

In those unexpected cases, the EPDP Team agreed that the affected delegated gTLDs and their delegated and allocated variant labels (if any) will be grandfathered. This is foreseen in the LGR Procedure, which states that “While existing labels will almost certainly have to be grandfathered if they are in conflict with the label generation rules established by this procedure, that precedent and conflict is not a reason to invalidate any aspect of the new rules or this procedure.”¹⁵⁵

The EPDP Team specified that grandfathered in this instance means that the proposed RZ-LGR update will apply to future new gTLDs and their variant labels and will not be retroactive. The registry operator will be able to continue to operate the affected gTLD and its delegated and allocated variant labels (if any). However, the registry operator will not be allowed to apply for any additional variant labels unless they are deemed valid and allocatable according to the updated version of the RZ-LGR. There will be no change to the contractual and delegation state of the delegated gTLDs and their delegated and allocated variant labels (if any), which predate the proposed RZ-LGR update and are subject to the version of RZ-LGR when those gTLDs and variant labels were initially applied-for upon the finalization of the New gTLD Program application process. This definition seeks to provide safeguards for the affected Internet stakeholders, such as registries, registrars, registrants, resellers, and end users.

The EPDP Team further agreed that the GP proposing such an update must call out the exception during a Public Comment period and explain the analysis and reasons for not supporting such gTLDs and their delegated and allocated variant labels (if any) in their script proposal.

Rationale for Implementation Guidance 8.9: As grandfathering will allow the gTLD to continue operating despite its incompatibility with the RZ-LGR, the EPDP Team recommends that the GP include, in the Public Comment, an opinion on any identified security and stability risks associated with not achieving full backward compatibility, as well as possible actions to mitigate the risks to the extent feasible.

To ensure balanced representation of the issues, the EPDP Team recommends that in the relevant Public Comment, there should also be an assessment, conducted by ICANN org, of the potential impact of grandfathering on the gTLD registry operator as well as the user experience of other affected Internet stakeholders. Such assessment should also include proposed measures to reduce the negative impact of grandfathering. In the event security and stability

¹⁵⁵ See Section A.3.5 of the Root Zone IDNA Label LGR Development and Maintenance, p.10:
<https://www.icann.org/en/system/files/files/draft-lgr-procedure-20mar13-en.pdf#page=10>

risks are identified, the assessment should include possible measures to minimize the risks that would result in minimal disruption to registries, registrars, registrants, and end users.

With the understanding that the requested analysis and assessment may be beyond the scope of work done by the GP and IP and additional experts may need to be consulted, the EPDP Team believes that ICANN org is in the best position to facilitate a dialogue between the affected gTLD registry operator, relevant function(s) in ICANN org, the GP, other experts and affected parties. In particular, ICANN org appears to be appropriately positioned to facilitate such an assessment of the potential impact of grandfathering, which should be included in the Public Comment. To the extent any proposed measures would require contractual amendments, they would need to be managed under the existing provisions of the relevant Registry Agreement.

The EPDP Team affirmed that the public should have an opportunity to comment on all these elements in the Public Comment period. The Integration Panel is urged to take such comments into account when reviewing and considering the proposal for integration into the next version of the RZ-LGR.

A6 Public Comment Review:

Final Recommendations 8.6-8.8 and Implementation Guidance 8.9: Based on an input received from Public Comment, the EPDP Team agreed to append a disclaimer in the rationale, recognizing that GPs and IP are not bound by ICANN consensus policies. Nevertheless, the EPDP Team requests ICANN org to share these recommendations for their consideration when updating the RZ-LGR. In Final Recommendation 8.6, the EPDP Team also emphasized that there is an existing stability principle in the LGR Procedure that GPs and IP must follow.

D8 Charter Question:

What additional updates to the Registry Agreement are necessary to ensure the labels under variant TLDs follow the “same entity” rule? For example, the Staff Paper recommends that the following requirements must be included in the Registry Agreement; some of the charter questions are also related to those topics:¹⁵⁶

- *Subordinate names allocated by the Registry Operator in the TLD be treated as an atomic set. This is true irrespective of whether any of the names is actually activated in the DNS, and whether any of the variants is actually registered. [related to questions C1, D4, D5]*
- *All the different IDN tables being used by the IDN gTLD and its variant gTLDs be harmonized. [related to questions C4, C5]*

¹⁵⁶ Section 3.6 in the Staff Paper, p.16: <https://www.icann.org/en/system/files/files/idn-variant-tld-recommendations-analysis-25jan19-en.pdf#page=16>:

- *All the IDN variant TLDs be implemented through the same registry service provider, to promote a consistent and stable implementation across all such variant TLDs. [related to questions B2, B4]*

Are there any additional updates that need to be considered that are not included in this list?

D8 Final Recommendations:

Final Recommendation 8.10: A primary gTLD that is removed from the root zone, either voluntarily or involuntarily, must also require the removal of its delegated variant label(s) from the root zone.

Final Recommendation 8.11: A delegated variant label that is voluntarily removed from the root zone will not require the removal of the associated primary gTLD or its other delegated variant label(s).

Implementation Guidance 8.12: In the event that domain name registrations exist at the second-level under a delegated variant label, its registry operator's request for its removal from the root zone should include a transition plan, to be submitted to ICANN org for review, for the existing registrations under that variant label.

Final Recommendation 8.13: In the event that a gTLD is removed from the root zone as a consequence of its registry operator's breach of the Registry Agreement, the rest of its variant label set, if any, must also be removed from the root zone.

D8 Rationale for Final Recommendations:

Rationale for Final Recommendations 8.10-8.11, 8.13 and Implementation Guidance 8.12: The EPDP Team recognized that under various circumstances, a delegated primary gTLD or its delegated variant label may be removed from the root zone. From a purely technical perspective, each gTLD is an independent top-level label and there may not be an issue with removing one while retaining another. However, from a policy perspective, the EPDP Team believes that the principle of the "integrity of the set" must be preserved, and the primary gTLD is crucial to bring the variant label set into existence.¹⁵⁷ The primary gTLD's crucial role is consistently reflected in the EPDP Team's deliberations on [Final Recommendation 3.1](#), stating that an application for an allocatable variant label cannot precede an application for that variant label's primary gTLD string.

Therefore, the EPDP Team agreed that in the event a primary gTLD is removed from the root zone, any delegated variant label from its variant label set must be removed as well. However, any delegated variant label can be voluntarily removed from the root zone without affecting its delegated primary gTLD and any other delegated variant label(s) from that variant label set. The "integrity of the set" is not broken so long as the primary gTLD still remains delegated.

¹⁵⁷ See more detailed explanation of "Integrity of the Set" in Section 3: Glossary of this Final Report.

As such, the EPDP Team further agreed that voluntary removal of a variant label from the root zone is allowed, provided that the registry operator justifies the decision and submits a transition plan, for ICANN org’s review, for existing registrations under the variant label that it intends to remove. Considering the potential complexities introduced by removing a gTLD variant label that has third-party registrations as well as other delegated gTLDs from the same variant label set, requiring ICANN org’s review of the transition plan should help promote robust safeguards for registrants to ensure consumer trust in the Internet. In the event that the registry operator wishes to re-delegate a previously removed gTLD variant label, a new application for that variant label will be required.

In the event a label, whether a primary gTLD or a gTLD variant label, is removed from the root zone as a consequence of its registry operator’s breach of the Registry Agreement, the rest of the variant label set must also be removed from the root zone. The EPDP Team noted that the breach of the Registry Agreement does not always result in the removal of a delegated gTLD from the root zone. In the event of a breach, ICANN org would evaluate the consequences of a potential removal and take appropriate action. For example, it could also mean that the emergency transition of the gTLD to an Emergency Back-end Registry Operator (EBERO) provider is triggered. See [Final Recommendation 7.10](#) for EPDP Team’s recommendation on variant label management in the EBERO process.

D8 Public Comment Review:

Wording Change: [Final Recommendations 8.10-8.11 and 8.13](#) incorporated the suggested wording change raised in Public Comment, as explained in the Public Comment Review section for [Final Recommendation 2.1](#): Remove the mention of “IDN” in order to future-proof potential updates to the RZ-LGR, in the event that allocatable variant labels are created from ASCII code points.

Implementation Guidance 8.12: The EPDP Team considered a concern raised in Public Comment and agreed to develop this implementation guidance to clarify the expectation that a transition plan is required and should be reviewed by ICANN org, in the event that domain name registrations exist under a gTLD variant label which its registry operator intends to remove. In addressing a question raised in Public Comment regarding any opportunity for the re-delegation of a previously removed gTLD variant label, the EPDP Team agreed that a registry operator who wishes to re-delegate its previously removed gTLD variant label may submit a new application for that variant label and therefore did not believe it was necessary to propose any further guidance on the said question of re-delegation.

Final Recommendation 8.13: The EPDP Team accepted minor wording revisions proposed by a commenter to enhance clarity, as well as added more detail in the rationale to emphasize that a breach of contract does not necessarily lead to the removal of a gTLD from the root zone.

4.9 Variant Label States

A9 Charter Question:

A given label in an Internationalized Domain Label (IDL) set may be in one of the following non-exhaustive status: delegated, withheld-same-entity, blocked, allocated, rejected. The WG and the SubPro IRT to coordinate and develop a consistent definition of variant label status in the IDL set.

A9 Final Recommendations:

Final Recommendation 9.1: A given variant label must have one of the following label states at any one time: delegated, allocated, withheld-same-entity, blocked, or rejected.¹⁵⁸ If the same terminology is used for certain label states and new gTLD application states, their respective definitions must be consistent.

Implementation Guidance 9.2: The label state for each variant label of an already delegated primary gTLD should be recorded and tracked by ICANN org so long as the primary gTLD remains delegated. Such records, including historical ones, should be maintained in a practical manner and made publicly accessible.

A9 Rationale for Final Recommendations:

Rationale for Final Recommendation 9.1: The EPDP Team had considerable discussion of this charter question but agreed to accept the label states proposed in the Staff Paper as a recommendation.¹⁵⁹ The EPDP Team learned that the label states are expected to be used for tracking the states of variant labels and be applied to the different stages in the New gTLD Program, as well as other processes (e.g., IDN ccTLD processes). The EPDP Team also agreed that label states and their definition should remain TLD-neutral, so that they can be applied consistently across gTLDs and ccTLDs to the extent possible.

During its deliberation, the EPDP Team learned that the label state “Delegated” overlaps with the application state “Delegated” in the New gTLD Program; the label state “Rejected” encompasses both the application states “Not Approved” and “Will Not Proceed”.¹⁶⁰ The Staff Paper does not provide an explicit definition of the label states but references the definitions in the Integrated Issues Report of 2012.¹⁶¹ Additional explanations of the meanings of the label states are provided in “Section 3: Glossary” of this Final Report. The EPDP Team recommends

¹⁵⁸ See more detailed explanation of these label states in Section 3: Glossary of this Final Report.

¹⁵⁹ See Section 3.4 of the Staff Paper, p.12: <https://www.icann.org/en/system/files/files/idn-variant-tld-recommendations-analysis-25jan19-en.pdf#page=12>

¹⁶⁰ See more information about the New gTLD Application states here:

<https://newgtlds.icann.org/en/applicants/advisories/application-contention-set-14mar14-en>

¹⁶¹ See Appendix A of the Staff Paper, p.4: <https://www.icann.org/en/system/files/files/idn-variant-tld-appendices-25jan19-en.pdf#page=4>. Integrated Issues Report: <https://www.icann.org/en/system/files/files/idn-vip-integrated-issues-final-clean-20feb12-en.pdf>

that if the same terminology is used for certain label states and new gTLD application states, their respective definitions must remain consistent to ensure they mean exactly the same thing.

Rationale for Implementation Guidance 9.2: The EPDP Team agreed that the label state for each variant label of an already delegated primary gTLD should be recorded by ICANN org in a practical manner and made publicly accessible. This will help raise awareness about the state of the variant labels associated with such primary gTLDs. This will also help inform potential applicants so they could avoid applying for strings that are variant labels of already allocated or delegated gTLDs. On this basis, the EPDP Team agreed that as long as the primary gTLD remains delegated, ICANN org should maintain the label states of the primary gTLD and its variant labels. In the event that label state transitions occur, ICANN org should also keep a history of changes for the variant label state. See [Final Recommendation 9.3](#) for details regarding the label state transition.

A9 Public Comment Review:

Final Recommendation 9.1 and Implementation Guidance 9.2: Several commenters supported these recommendations as written.

A10 Charter Question:

Individual labels in an Internationalized Domain Label (IDL) set may go through the following possible status transformations:

- **from “withheld-same-entity” to “allocated”:** Allocation only to the same entity as another label in the IDL set. This change happens if a variant was not initially requested for allocation and later is. Allocating withheld labels would be the application process for a variant TLD.
- **from “blocked” to “withheld-same-entity”:** A later LGR may broaden the available labels in the IDL set. Such possible labels automatically become withheld-same-entity.
- **from “allocated” to “delegated”:** Happens when name servers are added. (Not new.)
- **from “delegated” to “allocated”:** If a domain is removed from the DNS, the allocation can remain in place anyway. Rare in the root zone, but not new.
- **from “rejected” to “withheld-same-entity”:** Every Rejected label is automatically Withheld-same-entity as well. If the Rejected status comes off, the label can be handled as any other Withheld-same-entity label.

Note that an allocated or withheld-same-entity label cannot become blocked unless a new version of the LGR makes this possible. The WG and the SubPro IRT to coordinate and consider the following questions in order to develop a consistent solution: what is the procedure to change the label status for individual variant labels?

A10 Final Recommendations:

Final Recommendation 9.3: A variant label may go through the following transitions:

1. from “blocked” to “withheld-same-entity”;
2. from “withheld-same-entity” to “blocked”;
3. from “rejected” to “withheld-same-entity”.
4. from “withheld-same-entity” to “allocated”;
5. from “allocated” to “withheld-same-entity”;
6. from “allocated” to “delegated”;
7. from “delegated” to “allocated”

See below a visualization of the label state transitions.

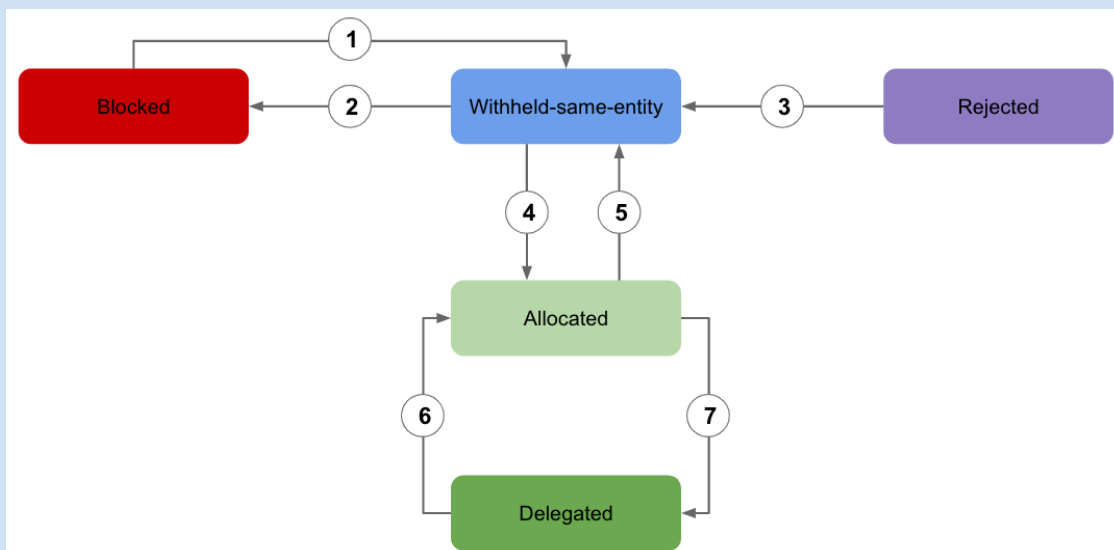

Implementation Guidance 9.4: A variant label state transition may occur in scenarios including but not limited to the following:

1. **from “blocked” to “withheld-same-entity”:** This transition happens when a later version of the RZ-LGR increases the allocatable labels from a variant label set, making a previously blocked label into an allocatable one; when it happens, such a variant label automatically becomes withheld-same-entity.
2. **from “withheld-same-entity” to “blocked”:** This transition happens when a later version of the RZ-LGR reduces the allocatable labels from a variant label set, which is an unlikely but possible scenario; such a variant label which is no longer able to be allocated or delegated to the root zone becomes blocked.
3. **from “rejected” to “withheld-same-entity”:** This transition happens when the condition which led to the rejection of a label no longer applies; such a variant label can be treated as any other withheld-same-entity label.
4. **from “withheld-same-entity” to “allocated”:** This transition happens if a variant label was not initially applied for but later is; allocating a withheld variant label would require the application process for such a label.

5. **from “allocated” to “withheld-same-entity”**: This transition happens when a gTLD variant label completes the termination process, and the allocation in the root zone no longer remains in place.
6. **from “allocated” to “delegated”**: This transition happens when the allocated label has been placed as a gTLD in the root zone of the Domain Name System (DNS), which then facilitates the registry operator’s ability to commence the process of bringing the registry service into production.
7. **from “delegated” to “allocated”**: This transition happens when a gTLD is removed from the DNS; its allocation can still remain in place.

A10 Rationale for Final Recommendations:

Rationale for Final Recommendation 9.3 and Implementation Guidance 9.4: Following considerable discussion of charter question A9, which is closely related to this charter question, the EPDP Team agreed to accept the five label state transitions proposed in the Staff Paper (the transition numbers correspond to the numbers in the graphic under [Final Recommendation 9.3](#); the respective explanations of the label state transitions, as understood by the EPDP Team, are included in [Implementation Guidance 9.4](#)):¹⁶²

1. from “blocked” to “withheld-same-entity”
3. from “rejected” to “withheld-same-entity”
4. from “withheld-same-entity” to “allocated”
6. from “allocated” to “delegated”
7. from “delegated” to “allocated”

Since the EPDP Team did not develop new label states in addition to what was already proposed in the Staff Paper (see [Final Recommendation 9.1](#)), it reached a logical conclusion to also accept the label state transitions identified in the Staff Paper.

The EPDP Team, however, disagreed with the explanatory remarks in the Staff Paper that the transition from “rejected” to “withheld-same-entity” is automatic. The EPDP Team noted that similar to other transitions which happen on the basis of a trigger and are not automatic, the transition from “rejected” to “withheld-same-entity” only happens when the ground for rejection is removed.

In addition, the EPDP Team identified two additional label state transitions not proposed in the Staff Paper (see their respective explanations in [Implementation Guidance 9.4](#)):

2. from “withheld-same-entity” to “blocked”
5. from “allocated” to “withheld-same-entity”

A10 Public Comment Review:

Final Recommendation 9.3: Several commenters supported this recommendation as written.

¹⁶² See Section 3.4 of the Staff Paper, p.12: <https://www.icann.org/en/system/files/file%20s/files/idn-variant-tld-recommendations-analysis-25jan19-en.pdf#page=13>

Implementation Guidance 9.4: The EPDP Team accepted minor wording revisions proposed by a commenter to enhance clarity with regard to the transition from “rejected” to “withheld-same-entity”.

4.10 Charter Questions with No Recommendations

A4 Charter Question:

For future gTLD applications, the SubPro PDP proposes an implementation guidance that if a script is not yet integrated into the RZ-LGR, applicants should be able to apply for a string in that script, and it should be processed up to but not including contracting.¹⁶³ Applicants under such circumstances should be warned of the possibility that the applied-for string may never be delegated and they will be responsible for any additional evaluation costs. The burden in this case is on the applicant, who may have to wait for an indeterminate amount of time but is not aware of any other serious concerns. The SubPro PDP developed this implementation guidance by taking into consideration the TSG recommendation that the application should remain on-hold (or other appropriate status) until the relevant script is integrated into the RZ-LGR.¹⁶⁴

*The WG and the SubPro IRT to coordinate and consider the following questions in order to develop a consistent solution: should the SubPro recommendation be extended to existing TLDs that apply for a variant TLD label whose script is not yet supported by the applicable version of the RZ-LGR? Consider this question in tandem with **B4** and by taking into account the data to be collected in the “Data and Metric Requirements” section of this charter. If not, what should be the process for an existing TLD registry who wishes to apply for a variant TLD label whose script is not yet supported by the applicable version of the RZ-LGR?*

A4 EPDP Team Response:

The EPDP Team agreed that this charter question is moot as all scripts of all existing delegated gTLDs from the 2012 round are already integrated into the RZ-LGR version 5, which was published on 26 May 2022.¹⁶⁵ Hence no recommendation or implementation guidance is needed.

A2 Charter Question:

Before the proposed RZ-LGR mechanism, applications for IDN gTLDs have asked the applicant to identify and list any variant labels (based on their own calculations) corresponding to the applied-for string. The self-identified “variant” labels do not have legal standing, as “[d]eclaring variant strings is informative only and will not imply any right or claim to the declared variant

¹⁶³ See Implementation Guidance 25.3 in the SubPro PDP Final Report, p.115:

<https://gnso.icann.org/sites/default/files/file/field-file-attach/final-report-newgtld-subsequent-procedures-pdp-02feb21-en.pdf#page=115>

¹⁶⁴ It is important to recognize that the RZ-LGR can be updated to include additional scripts as long as it is done in compliance with the LGR Procedure. The practical limitation, however, is that the time to create an LGR script proposal varies greatly (i.e. months or years). See Recommendation 5 in the TSG report, p.7:

<https://www.icann.org/en/system/files/files/rz-lgr-technical-utilization-recs-07oct19-en.pdf#page=7>; for additional context and rationale, see Appendix A of the Recommendations for Technical Utilization of RZ-LGR, pp.11-12: <https://www.icann.org/en/system/files/files/rz-lgr-technical-utilization-recs-07oct19-en.pdf#page=11>

¹⁶⁵ Learn more about the RZ-LGR version 5 here: <https://www.icann.org/en/announcements/details/icann-publishes-root-zone-label-generation-rules-version-5-rz-lgr-5-26-05-2022-en>

strings.”¹⁶⁶ The TSG recommends that the self-identified “variant” labels which are also variant labels calculated by RZ-LGR will need to be assigned a variant disposition based on RZ-LGR calculation, as discussed in **A1**.

If some self-identified “variant” TLD labels by the former gTLD applicants are not found consistent with the calculation of the RZ-LGR, but have been used to certain extent (e.g., used to determine string contention sets), how should such labels be addressed in order to conform to the LGR Procedure and RZ-LGR calculations? Consider this question by taking into account the data to be collected in the “Data and Metric Requirements” section of this charter.

A2 EPDP Team Response:

The EPDP Team agreed that no recommendation or implementation guidance is needed for the self-identified gTLD “variant” labels in the 2012 round, as they do not have legal standing and are for information purposes only. It does not matter whether any of the self-identified “variant” labels were used for any purpose in the 2012 round (if at all).

B3 Charter Question:

Beyond having the same Registry Operator and same back-end registry service provider, as referenced in **B1** and **B2**, is there a need for additional constraints for the same entity requirement for the top-level?¹⁶⁷ If so, the rationale must be clearly stated.

B3 EPDP Team Response:

The EPDP Team agreed that there was no need for additional constraints for the “same entity” requirement for the top-level beyond the current EPDP-IDNs Phase 1 final recommendations and implementation guidance.

E6 Charter Question:

The WG and the SubPro IRT to coordinate and consider the following questions in order to develop a consistent solution: is there any reason to permit the registration of gTLDs consisting of decorated two-character Latin labels which are not variant labels of any two-letter ASCII

¹⁶⁶ For more details see gTLD Applicant Guidebook, version 2012-06-04, section 1.3.3 IDN Variant TLDs, p.1-35: <https://newgtlds.icann.org/en/applicants/agb/guidebook-full-04jun12-en.pdf>

¹⁶⁷ The initial set of TLD variant label management recommendations proposed for Public Comment also required that the TLD variant labels be implemented using the same nameservers, unless otherwise justified. However, that recommendation is now removed based on the feedback received by the community asking for more operational flexibility in the implementation of TLD variant labels.

labels?¹⁶⁸ If so, rationale must be clearly stated.

E6 EPDP Team Response:

The EPDP Team noted that the standard used in the String Similarity Review from the 2012 round will continue in the future rounds, per SubPro Affirmation 24.2.¹⁶⁹ Specifically, an applied-for two-character gTLD string, regardless of script or language, will be reviewed for visual similarity to any two-character ASCII combination in order to protect possible future ccTLD delegations. As such, the EPDP Team noted that an applied-for gTLD string consisting of decorated two-character Latin labels will be evaluated for visual similarity to any two-character ASCII combination. A string that does not pass the evaluation will not be able to proceed in the application process.

EPDP Team agreed not to develop any additional recommendation on this topic but to rely on the existing process of using the String Similarity Review to catch any applied-for gTLD string in any script, not limited to the Latin script, that may be potentially confusable with a two-character ASCII combination. The EPDP Team noted that such confusability issues may also exist in other scripts, such as Cyrillic, Ethiopic, Gujarati, Hebrew, and Malayalam scripts.¹⁷⁰

B4a Charter Question:

For the variant labels with status “withheld for the same entity” (i.e. not requested for allocation in the application process), what role do they play?

B4a EPDP Team Response:

The EPDP Team interpreted the question as follows: “What role do the non-applied-for allocatable variant labels play in the application process?” It is only when an applied-for primary gTLD string is allocated or delegated as a result of the application being approved that its non-applied-for allocatable variant label(s) become “withheld for the same entity”.

The non-applied-for allocatable variant labels will be taken into account in at least three aspects of the evaluation process for new gTLD applications: 1) String Similarity Review, 2) String Confusion Objection, and 3) Contention Resolution. See details explained in [Final Recommendations 4.1-4.4, 5.2-5.3, 6.1-6.2.](#)

¹⁶⁸ The ccTLD labels in the root depend on an external registry (ISO 3166) that allocates alphabetic codes to countries. In order to ensure that no conflicts with future assignments by ISO can happen, ICANN has traditionally also maintained a restriction against the use of two-letter TLDs for all Latin script letters; no variant labels should be generated for ccTLDs based on the ISO3166 codes. This principle is also reaffirmed by the SubPro PDP. See Recommendation 21.6 in the SubPro Final Report, p.95: <https://gnso.icann.org/sites/default/files/file/field-file-attach/final-report-newgtld-subsequent-procedures-pdp-02feb21-en.pdf#page=95>

¹⁶⁹ See Affirmation 24.2 in the SubPro PDP Final Report, p.108: <https://gnso.icann.org/sites/default/files/file/field-file-attach/final-report-newgtld-subsequent-procedures-pdp-02feb21-en.pdf#page=108>

¹⁷⁰ The EPDP Team reviewed examples in those scripts during its meeting on 10 November 2022. See slides here: <https://community.icann.org/download/attachments/218465843/EPDP%20Team%20Meeting%20%2357%20Slides%20-%20E2%2C%20E6.pdf?version=1&modificationDate=1668108498000&api=v2>

E1 Charter Question:

*In considering the conclusion(s) with respect to question **B4a**, what role, if any, do TLD labels “withheld for possible allocation” or “withheld for the same entity” play vis-a-vis:*

- *objection process; and*
- *string similarity review process?*

E1 EPDP Team Response:

The EPDP Team interpreted the question as follows: “What role do the non-applied-for allocatable variant labels play in the application process?” It is only when an applied-for primary gTLD string is allocated or delegated as a result of the application being approved that its non-applied-for allocatable variant label(s) become “withheld for the same entity”.

The non-applied-for allocatable variant labels will be taken into account in at least three aspects of the evaluation process for new gTLD applications: 1) String Similarity Review, 2) String Confusion Objection, and 3) Contention Resolution. See details explained in [Final Recommendations 4.1-4.4, 5.2-5.3, 6.1-6.2](#).

E7 Charter Question:

Besides the objection process, string similarity review, and string contention resolution, what other ICANN policies and procedures should be updated to enforce the “same entity” rule and the use of RZ-LGR as the sole source to calculate the variant Labels and disposition values?¹⁷¹ See the list of ICANN Consensus Policies here:

<https://www.icann.org/resources/pages/registrars/consensus-policies-en>

E7 EPDP Team Response:

An EPDP Team member suggested that the group consider whether additional recommendations are needed with respect to the treatment of singular/plural versions of an applied-for primary gTLD string and its variant label(s) in the String Similarity Review. The EPDP Team reviewed SubPro PDP Outputs regarding the singular/plural issues, specifically the SubPro PDP Recommendation 24.3, Implementation Guidance 24.4, and Recommendation 24.5.¹⁷² While the EPDP Team reaffirmed the SubPro PDP Outputs, some members questioned why the Outputs are limited to singular/plural issues but not other morphological phenomena.

¹⁷¹ IDN Variant TLD Implementation Staff Paper: <https://www.icann.org/en/system/files/files/idn-variant-tld-recommendations-analysis-25jul18-en.pdf>

¹⁷² See details in the SubPro PDP Final Report, pp.108-111: <https://gnso.icann.org/sites/default/files/file/field-file-attach/final-report-newgtld-subsequent-procedures-pdp-02feb21-en.pdf#page=108>

Other members also raised questions on how the SubPro PDP Outputs would be put into practice. Nevertheless, the EPDP Team agreed that those issues are out of scope for the EPDP Team but would instead be addressed during the implementation of the SubPro PDP Outputs. The EPDP Team also agreed that no additional recommendations need to be developed to address the singular/plural issues to complement its recommendations for the String Similarity Review (see [Final Recommendations 4.1-4.3](#)).

A8 Charter Question:

What additional aspects of gTLD policies and procedures, which are not considered in the above charter questions, need to be updated to ensure that the validation of existing TLD labels and calculation of variant labels depend exclusively on the RZ-LGR in a consistent manner?

A8 EPDP Team Response:

An EPDP Team member suggested that the group consider what contextual information should be included in the registration data for variant labels of delegated primary gTLDs, both in the IANA WHOIS and Registry WHOIS. The EPDP Team plans to address this question in Phase 2 of its deliberation, specifically under charter question D8, as this issue is more related to second-level domain name registrations.

5 Differences between EPDP-IDNs and ccPDP4 Recommendations

5.1 Background

On 14 March 2019, the ICANN Board approved a set of recommendations for managing the variant TLDs that were developed by ICANN org in the “Staff Paper”. At this time the Board also requested that the:

- ccNSO and GNSO taking into consideration the variant TLD recommendations in the Staff Paper while developing their respective policies to define and manage the IDN variant TLDs for the current TLDs as well as future TLD applications; and
- ccNSO and GNSO keep each other informed of the progress in developing the relevant details of their policies and procedures to ensure a consistent solution, based on the variant TLD recommendations, is developed for variant ccTLDs and variant gTLDs.

In 2021, the GNSO and the ccNSO commenced their respective PDPs dedicated to IDNs:

- the GNSO Council approved the charter for an Expedited Policy Development Process on IDNs (“EPDP-IDNs”) in May 2021;¹⁷³ and
- the ccNSO Council approved the charter for Policy Development Process 4 on the (de)Selection of IDN ccTLD Strings (“ccPDP4”) in August 2021.¹⁷⁴

In response to the Board’s request that the two efforts keep each other informed, the EPDP-IDNs and ccPDP4 appointed liaisons to the respective efforts to identify potential issues and share information. The PDP groups also meet periodically to discuss the alignment of their recommendations. In addition, the ICANN org staff that support both efforts are also in regular contact.

In the EPDP-IDNs Phase 1 Initial Report, the EPDP Team identified preliminary recommendations under four (4) topics covered by both EPDP-IDNs and ccPDP4 where differences existed at the

¹⁷³ EPDP-IDNs charter:

<https://gnso.icann.org/sites/default/files/policy/2021/presentation/CharterGNSOIDNsEPDPWorkingGroup20May21.pdf>

¹⁷⁴ ccPDP4 charter:

<https://community.icann.org/download/attachments/138969190/Draft%20Charter%20ccPDP4%20WG.pdf?version=1&modificationDate=1592141220002&api=v2>

time.¹⁷⁵ The ccPDP4 Working Group published its Initial Report on 9 August 2023, and the EPDP Team conducted an updated analysis for inclusion in its Phase 1 Final Report.¹⁷⁶

Compared to the initial analysis, the EPDP Team noted that one area of difference no longer exists (i.e., impact on delegated TLDs due to RZ-LGR update), as ccPDP4 aligned their recommendation with that of the EPDP Team, and two additional topics have now been identified.¹⁷⁷ As such, recommendations under a total of five (5) topics covered by both EPDP-IDNs and ccPDP4 have differences. However, these differences are largely considered reflective of fundamental differences that already exist in the management and operation of ccTLDs and gTLDs, and their associated application processes, rather than an inconsistent application of the variant TLD recommendations.

The EPDP Team conducted an analysis of the differences, from the gTLD perspective and the findings are provided below. It should be noted that the preliminary recommendations from ccPDP4 may be modified in the future following the Public Comment process for its Initial Report.

5.2 Analysis of Recommendations with Differences

No.	Topic	EPDP-IDNs	ccPDP4
1	Variant label disposition	“Allocatable” and “blocked” (see Section 3: Glossary)	“Delegatable”, “allocatable”, and “blocked” (see Annex A: Glossary of Terminology Used in Policy Proposal)
<p>Summary of Differences: EPDP-IDNs agreed to use the disposition values of allocatable or blocked variant labels as specified in the RZ-LGR. ccPDP4 created an additional disposition value of “delegatable”, which means an allocatable variant label that meets the general criteria for selection of IDNccTLD strings (meaningful in an official language and expressed in the related script) and is eligible for delegation. Other non-delegatable allocatable variant labels are not allowed for application for ccTLDs.</p>			
<p>Analysis: The EPDP Team believes this difference in disposition values is acceptable and reflects one of the primary differences between a ccTLD and a gTLD in that a ccTLD ultimately represents a country or territory name. It is not necessary for the EPDP to also adopt the ‘delegatable’ disposition value as it would have no meaning in the gTLD</p>			

¹⁷⁵ See Section 5 of the EPDP-IDNs Phase 1 Initial Report here: <https://itp.cdn.icann.org/en/files/internationalized-domain-names-idn/phase-1-initial-report-internationalized-domain-names-expedited-policy-development-process-24-04-2023-en.pdf#page=95>

¹⁷⁶ See the ccPDP4 Initial Report Public Comment here: <https://www.icann.org/en/public-comment/proceeding/ccnso-pdp4-initial-report-on-the-de-selection-of-idnccTlds-16-08-2023>

¹⁷⁷ See p.28 in ccPDP4 Initial Report: 6.2.4. Impact of possible amendment of RZ-LGR. “It is expected that the RZ-LGR be revised throughout its lifecycle, because a new script LGR is being integrated or a revision of an existing script LGR is being integrated into the Root Zone LGR. There may be a case where the update in the Root Zone LGR does not support an existing IDNccTLD. In such a case, the delegated IDNccTLD(s) must be grandfathered.”

No.	Topic	EPDP-IDNs	ccPDP4
	landscape.		
2	Limiting number of delegated variant labels	<p><u>Final Recommendation 8.1</u>: No ceiling value for delegated top-level variant labels from a variant label set is necessary as existing measures in the RZ-LGR to reduce the number of allocatable top-level variant labels, as well as economic, operational, and other factors that may impact the decision to apply for variant labels, will keep the number of delegated top-level variant labels conservative.</p>	<p><u>6.2.3</u>: Limitation of delegation of variants. Only Allocatable Variants of the selected IDNccTLD string that are Meaningful Representations of the name of the Territory in the Designated Language are eligible to be delegated.</p>
<p>Summary of Differences: EPDP-IDNs agreed not to impose a ceiling for the number of allocatable variant labels that can be delegated for any one primary gTLD string whereas ccPDP4 agreed that only a subset of allocatable variant labels that are a meaningful representation of territory names can be requested as ccTLDs.</p>			
<p>Analysis: The EPDP Team does not consider these recommendations to be inconsistent. The ccPDP4 has not placed a ceiling on the number of allocatable variant labels, but the recommendation does state that only allocatable variant labels that are ‘meaningful representations of the name of the Territory in the Designated Language are eligible to be delegated.</p> <p>The EPDP Team acknowledges that this qualification may be seen by some as creating an artificial ceiling and it is noted in the deliberations on this topic the Team came to appreciate that there are also factors that serve to create an artificial ceiling for gTLD variant labels as well. For example, only seven scripts in the current RZ-LGR have allocatable variant labels and except for the Arabic script, the other six scripts have already limited the number of allocatable variant labels that can be applied for.</p>			
3	String Similarity Review	<p><u>Final Recommendation 4.1-4.3</u>: The Hybrid Model as summarized below (see details in Section 4.4):</p> <p>At a minimum, the String Similarity Review must compare an applied-for primary gTLD string (no matter whether it is an ASCII string or</p>	<p><u>7.2.3.B</u> A Selected string, and its Requested, Delegatable Variants should not be confusingly similar with:</p> <ul style="list-style-type: none"> ● Any combination of two ISO 646 Basic Version (ISO 646-BV) characters (letter [a-z] codes), nor ● Existing TLDs, which shall

No.	Topic	EPDP-IDNs	ccPDP4
		<p>an IDN string) and all of its allocatable and blocked variant labels against the following, with the exclusion of comparing a blocked variant label against other blocked variant labels:</p> <ul style="list-style-type: none"> ● all existing gTLDs and ccTLDs and all of their allocatable and blocked variant labels; and ● requested ccTLD strings and all of their allocatable and blocked variant labels; and ● other applied-for gTLD strings and all of their allocatable and blocked variant labels; and ● any other two-character ASCII strings and all of their allocatable and blocked variant labels; and ● all strings on the New gTLD Program Reserved Names list and all of their allocatable and blocked variant labels. <p>As an exception, the String Similarity Review Panel may, in line with guidelines and/or criteria to be developed during implementation, decide whether and what blocked variant labels to omit when conducting comparison on the basis of a manifestly low level of visual confusability between the scripts of labels being compared.</p>	<p>also include the already delegated variants of the selected string or primary label and of reserved names, nor</p> <ul style="list-style-type: none"> ● Proposed TLDs which are in process of string validation and their requested Delegatable or requested variants (however defined under the ccTLD and gTLD processes) <p>The Similarity Evaluation Panel should determine which additional variants of the basic set of strings should be included in the Comparison Side, factoring in:</p> <ul style="list-style-type: none"> ● The likelihood of misconnection ● Scalability, and ● Unforeseen and/or unwanted side effect. <p>If the Panel decides to include additional variant labels in the comparison, it must specify which additional variant labels are included as well as provide the rationale for such inclusion.</p>

No.	Topic	EPDP-IDNs	ccPDP4
	<p>Summary of Differences: EPDP-IDNs agreed that the String Similarity Review must extend its visual similarity checks for the entire variant label set of an applied-for primary gTLD string, with some exceptions. ccPDP4 agreed to conduct visual similarity checks for the requested, delegatable strings, but the String Evaluation Panel may expand the comparison by including allocatable (and blocked, if needed) variant labels.</p> <p>Analysis: The differences are considered acceptable because the recommendations, while not the same, are developed in the context of the respective application processes for a new gTLD and ccTLD. The main difference in the processes being that gTLD strings are applied for in dedicated rounds that could result in hundreds if not thousands of applications being evaluated simultaneously, whereas an ccTLD can be applied for at any time and evaluations are discrete. The purpose and the intent of both string similarity review processes is considered consistent – it is only the manner in which this is done that differs.</p>		
4	<p>Single Character TLD Applications</p>	<p><u>Final Recommendation 3.17:</u> The EPDP Team affirmed the Recommendation 25.4 in the SubPro PDP Final Report that single-character gTLDs may only be allowed for limited scripts and languages where a character is an ideograph. At the time of the EPDP Team’s deliberations, the only script that meets the criteria is the Han script, which is used in the Chinese, Japanese, and Korean languages.</p>	<p><u>4.1:</u> Minimal Number of non-ASCII characters: Considering the need to ensure the security and stability of the DNS, the application for Single character IDNs under this proposed policy is currently deferred.</p>
<p>Summary of Differences: EPDP-IDNs agrees that single-character gTLDs in the Han script should be allowed, whereas ccPDP4 does not allow single-character ccTLDs until the first review of policy implementation of ccPDP4 recommendations at the earliest.</p>			
<p>Analysis: The difference is considered acceptable and reflects one of the primary differences between a ccTLD and a gTLD in that a ccTLD ultimately represents a country or territory name, and gTLDs do not have such a limitation. The ccPDP4 Initial Report notes that the ccTLD community does not see immediate need for a single-character ccTLD. In addition, the SubPro PDP recommendation 25.4 on single-character gTLDs has been adopted by the ICANN Board, and the EPDP’s <u>Final Recommendation 3.17</u> expands on the SubPro PDP recommendation by specifying the script and languages in which single-character gTLDs can be applied.</p>			
5	<p>Delegation timeframe of approved variant</p>	<p><u>Final Recommendation 8.4:</u> Applicants for a primary gTLD string and its applied-for</p>	<p><u>12.2:</u> Delegation of variant(s) of the selected IDNccTLD must be in accordance with current</p>

No.	Topic	EPDP-IDNs	ccPDP4
	labels	allocatable variant label(s) that pass evaluation must be subject to the terms and conditions, as recommended by the SubPro PDP, in respect of the timeframe for delegation, including the ability to apply for an extension of time for delegation.	policies, procedures, and practices for delegation of ccTLDs.
<p>Summary of Differences: EPDP-IDNs agreed that approved primary gTLD string and its variant labels must follow the specific timeframe, as recommended by SubPro PDP, for delegation. However, there is no delegation time frame specified for ccTLDs and their approved variant labels as a matter of policy.</p>			
<p>Analysis: The difference is considered acceptable and reflective of the fundamental differences that already exist in the management and operation of ccTLDs and gTLDs. For ccTLDs, an approved string can remain in the “allocated” status for a long time until it is eventually delegated. But for gTLDs, registry operators have contractual obligations to have the approved strings delegated within the timeframes specified in the Registry Agreement.</p>			

5.3 Additional Topics with Differences

The EPDP-IDNs and ccPDP4 each have a distinct scope and remit. Therefore, some topics addressed by the EPDP Team are not addressed by ccPDP4 and vice versa. The EPDP Team also noted that the ccPDP4 has limitations with regard to developing policy recommendations pertaining to ccTLD registrations at the second-level, whereas it is within the remit of the EPDP-IDNs to develop policy recommendations for variant management mechanisms at the second-level during Phase 2 of its deliberations.

Furthermore, the EPDP Team recognized that the ccPDP4 and SubPro PDP have different recommendations regarding the treatment of an applied-for gTLD string whose script is not yet integrated into the RZ-LGR. The SubPro PDP recommends that such an application should be accepted and processed up to but not including contracting, whereas the ccPDP4 recommends that such an application cannot proceed for evaluation until the relevant script is integrated into the RZ-LGR.¹⁷⁸ The EPDP Team noted that the SubPro PDP developed such a recommendation

¹⁷⁸ See Implementation Guidance 25.3 in the SubPro Final Report, p.115:

<https://gnso.icann.org/sites/default/files/file/field-file-attach/final-report-newgtld-subsequent-procedures-pdp-02feb21-en.pdf#page=115>. The ICANN Board has adopted this Output as part of its resolution in March 2023: <https://www.icann.org/en/board-activities-and-meetings/materials/approved-resolutions-regular-meeting-of-the->

based on the belief that the applicant should be provided the opportunity to apply for such a string, but the onus is on the applicant, who may have to wait for an indeterminate amount of time until the script of the applied-for string is integrated into the RZ-LGR.

[icann-board-16-03-2023-en](#). See section 7.1.1 Conformity to RZ-LGR in the ccPDP4 Initial Report: "...If at the time the requested IDNccTLD string is submitted for validation the LGR for the writing system or script in which the Designated Language is expressed has not been generated or is not yet integrated in the RZ-LGR, or if the selected IDNccTLD string is not in compliance with the RZ-LGR, ICANN shall inform the requester and section 11 applies accordingly."

6 Next Steps

6.1 Preliminary Conclusions

The EPDP-IDNs Team developed sixty-nine (69) Phase 1 recommendations, which include eleven (11) implementation guidance on how a recommendation should be implemented. Annex C provides the consensus designations for the recommendations included in this Phase 1 Final Report. In summary, all of the sixty-nine (69) final recommendations received “full consensus” support from the EPDP Team.

6.2 Next Steps

The Phase 1 Final Report will be submitted to the GNSO Council for consideration. If the Final Report is approved by the GNSO Council, it will be forwarded to the ICANN Board of Directors for consideration and potential action in accordance with the ICANN Bylaws.

The EPDP-IDNs Team will continue its deliberations on Phase 2 charter questions in accordance with its project plan and timeline.

7 Annex A – String Similarity Review Hybrid Model Deliberation

The EPDP Team affirmed the standard used in the String Similarity Review from the 2012 round of the New gTLD Program, but had significant discussion on the role of allocatable and blocked variant labels in the review. The EPDP Team began its deliberations on the role of variant labels by discussing three possible levels of comparison for visual confusability between applied-for gTLD strings and existing TLDs. These are summarized and illustrated in the rationale for [Final Recommendations 4.1-4.3](#).

In discussing these three levels, the EPDP Team also analyzed their impact on the String Similarity Review and potential consequences. Members were asked to express their views and rationale with regard to their preferred level. Despite these efforts, there was a divergence of opinions, partly due to the largely academic discussion of abstract concepts without concrete examples.

As such, the EPDP Team established the String Similarity Review small group, which was tasked with developing concrete examples of strings that have variant labels that may be visually confusable with other strings in the same or different scripts. The small group was also tasked to put forward recommendations, for consideration by the EPDP Team, on the level of comparison appropriate for String Similarity Review, using the example strings to showcase the impact on the review.¹⁷⁹

The small group developed eight sets of example strings in Arabic, Chinese (traditional and simplified), Cyrillic, Japanese, and Latin as documented in the following **Table 1**.¹⁸⁰ They examined the allocatable and blocked variant labels for each example string, as calculated by RZ-LGR.

- **Table 1: Example Strings Developed by String Similarity Review Small Group**

Set	Label A	Label B	Label C
1	Latin biß	Cyrillic biß	
2	Traditional Chinese 滙豐	Simplified Chinese 汇丰	

¹⁷⁹ Learn more about the String Similarity small group’s tasks in its assignment form here:

<https://community.icann.org/display/epdpidn/2022-05-18+IDNs+EPDP+String+Similarity+Review?preview=/197266252/197266624/String%20Similarity%20Review%20Small%20Group%20Assignment%20Form.pdf>

¹⁸⁰ The small group reported on their work to the EPDP Team on 11 August 2022. See examples of those strings on slide 10 here:

<https://community.icann.org/pages/viewpage.action?pageId=202704426&preview=/202704426/210469035/Package%20Report%20String%20Similarity%20Small%20Group%20Outcome.pdf>

3	Arabic بنى	Arabic بنى	
4	Simplified Chinese 华岛	Traditional Chinese 華島	
5	Latin rich	Latin řich	
6	Arabic ركى	Arabic رگے	
7	Simplified Chinese 华为	Simplified Chinese 华岛	Simplified Chinese 华岛
8	Japanese Kanji 一休	Traditional Chinese 一體	

After reviewing these examples, the small group converged on a mixed-level approach, which became known as the “Hybrid Model” and was explained in the rationale for [Final Recommendations 4.1-4.3](#). The small group also developed additional examples showcasing how the Hybrid Model would work when comparing Chinese gTLD strings.¹⁸¹

The small group put forward the Hybrid Model as it follows the principle of conservatism in the management of the root zone, which has been a technical principle and upheld by numerous studies and advice throughout the years.¹⁸² The principle of conservatism is also reflected in the String Similarity Review, the objective of which is to prevent user confusion and loss of confidence in the DNS resulting from delegation of visually similar strings.

The small group designed the Hybrid Model to mitigate the potential confusion risks from 1) denial of service/no-connection and 2) misconnection, which may be intensified by the introduction of gTLD variant labels. Compared to Level 3, the Hybrid Model also has the advantage of eliminating unnecessary complexity by not comparing blocked variant labels against blocked variant labels.

When the small group presented their recommendation for the Hybrid Model at the plenary level, the EPDP Team did not query the necessity of including all primary strings and all of their allocatable variant labels in the String Similarity Review. An allocatable variant label that is not applied for at the moment can still be applied for in the future and, as such, retains the potential to cause user confusion.

¹⁸¹ See pages 16-18 in this document for details:

<https://community.icann.org/pages/viewpage.action?pageId=202704426&preview=/202704426/210469035/Package%20Report%20String%20Similarity%20Small%20Group%20Outcome.pdf>

¹⁸² For example, RFC 5891 says that any domain name registry, including that of the root zone, should develop and apply additional restrictions as needed to reduce confusion and other problems (part of IDNA2008 standard). RFC 6921 notes that zones higher in the DNS tree tend to have more restrictive rules and the context is that the root zone serves the entire Internet population. SAC089 explains that confusability cannot be considered in isolation from other issues related to security; phishing and other social engineering attacks based on domain name confusion are a security problem for end users. The Staff Paper emphasizes that the variant implementation must be done in a way that operation and maintenance of the DNS not be adversely impacted by the introduction of gTLD variant labels; it should avoid including TLD variant labels in a manner that would create user vulnerabilities or a probability of confusion.

Nevertheless, some EPDP Team members expressed reservations about including blocked variant labels in the String Similarity Review, as those blocked variant labels cannot be delegated into the root zone. Some other EPDP Team members argued that while a label may be considered “blocked” according to the RZ-LGR and cannot be delegated as a top-level domain, the character, word, or phrase it represents may still appear in everyday life and cause confusion to users.

To demonstrate why blocked variant labels should also be included in String Similarity Review, ICANN org support staff developed the following **Illustration 1** to showcase a use case discussed by the small group where a blocked variant label may play a role in the resulting “misconnection”.¹⁸³

- **Illustration 1:** A user saw `http://shop.رکے` on an advertisement on a bus, which seemed to point to an online shopping site for shoes. The user thought it was `http://shop.رکے`, as the two labels look similar. When the user typed `http://shop.رکے` in the browser, the connection did not resolve because that domain was not registered. The user thought of `رکے`'s variant `رکی`, which is regarded as the same by Arabic speakers. The user typed `http://shop.رکی` in the browser to give it a try, and arrived at an online shopping site for handbags, which was not expected by the user. According to the RZ-LGR calculation, `رکے` is a blocked variant label of `رکی`, but a user would not know that nuance. The “misconnection” still happened because the user regarded `رکی` the same as `رکے`, which looks confusingly similar to `رکے`. The site the user eventually arrived at was different from the site advertised on the bus.

¹⁸³ For more details about this use case, check the recording of the EPDP-IDNs meeting #49 on 26 August 2022 here: <https://community.icann.org/x/LgYVD>

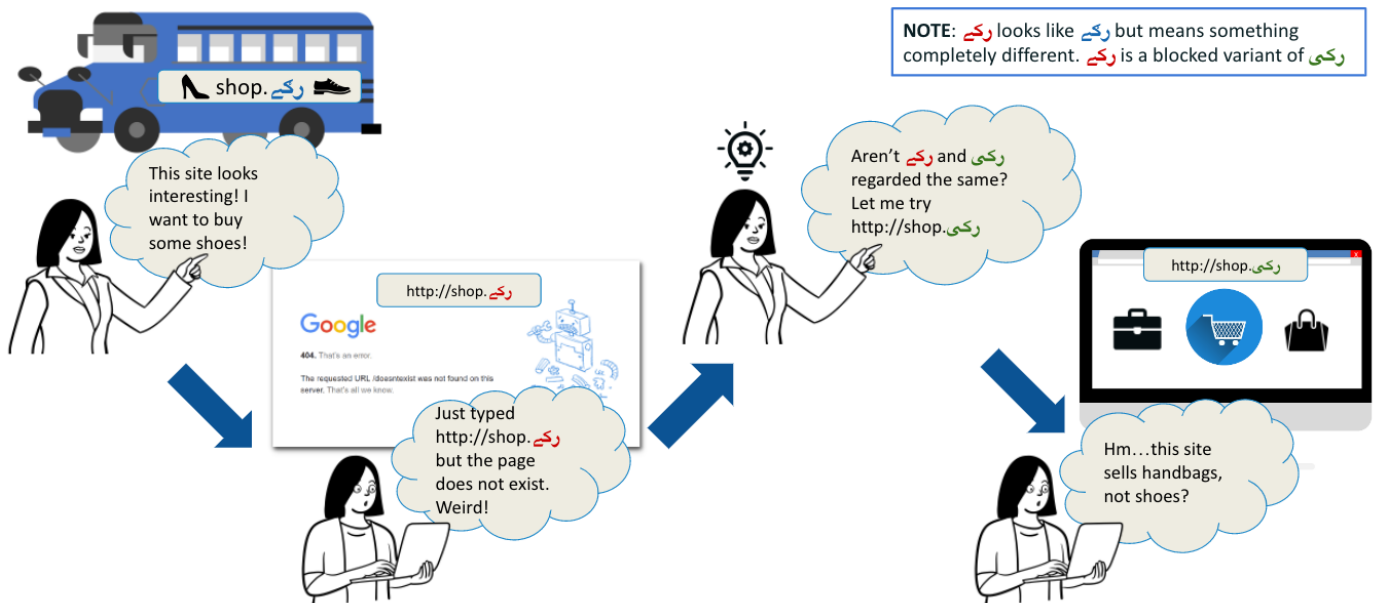

The small group recognized that the Hybrid Model will likely expand considerably the number of strings that need to be compared in the String Similarity Review, but it was not tasked to consider in detail the implementation complexity of the Hybrid Model. However, the small group developed an illustration to try to visualize the number of permutations created by the Hybrid Model, noting that the computational complexity increases as more strings are added into the comparison.

- Illustration 2:** Compare three applied-for primary Chinese gTLD strings and their variant labels using the Hybrid Model. Primary string A1 has one allocatable variant A2 and four blocked variant labels A3-A6. Primary string B1 has one allocatable variant B2 and 10 blocked variant labels B3-B12. Primary string C1 has one allocatable variant C2 and seven blocked variant labels C3-C9. The use of the Hybrid Model leads to 162 combinations for comparison among the three applied-for primary strings and their variant labels.

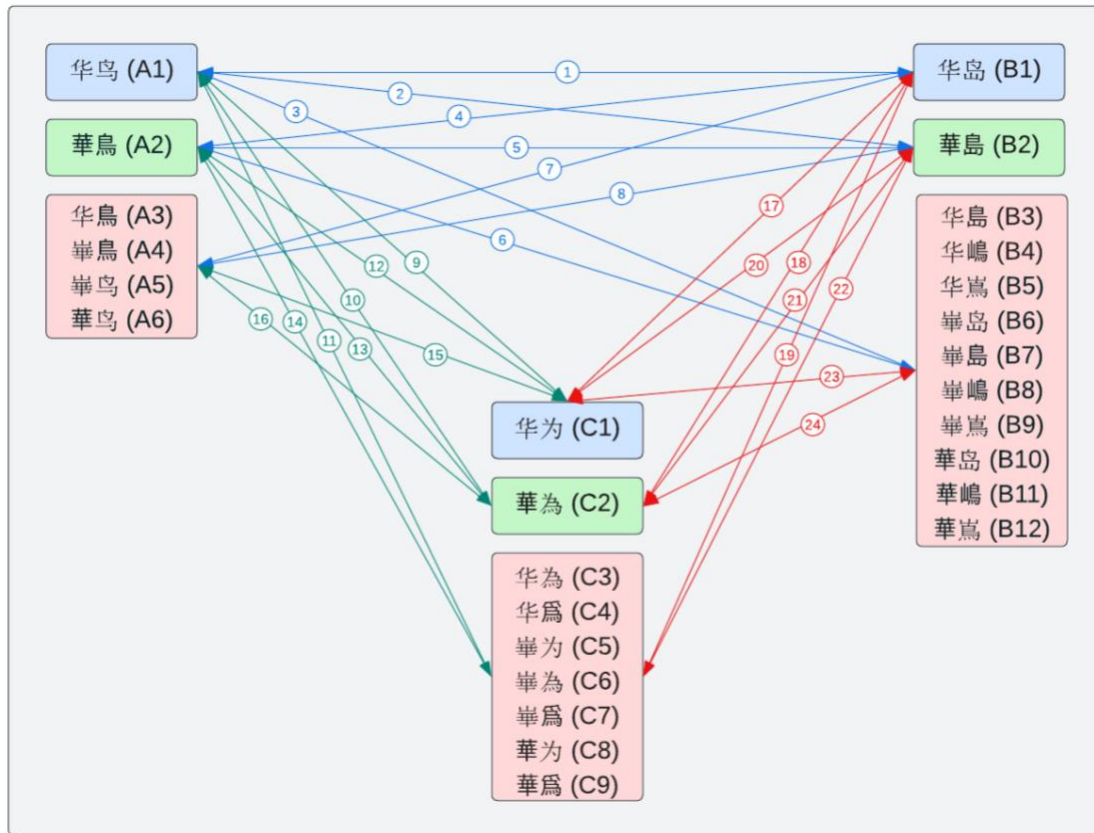

After considering these viewpoints and examples, the EPDP Team expressed general support for the Hybrid Model, as it seems sufficiently conservative to mitigate the denial of service/no-connection and misconnection risks caused by confusingly similar strings and variant labels, thereby helping to promote a good user experience.

The EPDP Team requested ICANN org to provide operational input to help the Team assess the implementation complexity and the cost/benefit of the Hybrid Model. In response, ICANN org conducted a sample analysis of existing strings to determine the theoretical number of comparisons that would need to be performed in String Similarity Review. This analysis was performed on the basis that each string was being compared with every other string, while disregarding their scripts and whether visual similarity actually existed. To curate real-life examples as the basis for comparison, ICANN org randomly selected 20 gTLDs from the 2012 round of the New gTLD Program, and used RZ-LGR version 5, which was the latest version available when ICANN org input was developed, to calculate the number of their allocatable and blocked variant labels. Subsequently, ICANN org calculated the theoretical number of comparison among these 20 primary gTLD strings and their variant labels using Level 1, Level 2, Level 3, and the Hybrid Model.

- **Illustration 3:** ICANN org developed this table to demonstrate the potential number of comparison among the 20 selected primary gTLD strings and their variant labels, using Level 1 (L1), Level 2 (L2), Level 3 (L3), and the Hybrid Model (Hybrid). "Target label"

means the label that the source label is being compared with. In Level 1, for example, one primary gTLD string no.1 will be compared against 19 target primary gTLD strings. The results show that the theoretical number of comparisons for Level 1 is 190, for Level 2 is 343, for Level 3 is 95,144, and for the Hybrid Model is 13,003.¹⁸⁴

#	Script	TLD	Source Label			Target Label			Number of Comparison			
			number of primary	number of allocatable	number of blocked	number of remaining primary	number of remaining allocatable	number of remaining blocked	L1 =DxG	L2 =(D+E)x (G+H)	Hybrid =(D+E)x (G+H+I)+Fx (G+H)	L3 =(D+E+F)x (G+H+I)
1	Chinese	网站	1	1	-	19	6	509	19	50	1,068	1,068
2	Chinese	游戏	1	1	10	18	5	499	18	46	1,274	6,264
3	Chinese	网址	1	1	2	17	4	497	17	42	1,078	2,072
4	Chinese	商店	1	-	3	16	4	494	16	20	574	2,056
5	Chinese	购物	1	1	-	15	3	494	15	36	1,024	1,024
6	Arabic	همراء	1	1	268	14	2	226	14	32	4,772	65,340
7	Arabic	ارامكو	1	2	147	13	-	79	13	39	2,187	13,800
8	Arabic	بازار	1	-	24	12	-	55	12	12	355	1,675
9	Japanese	ゲーグル	1	-	4	11	-	51	11	11	106	310
10	Japanese	家電	1	-	3	10	-	48	10	10	88	232
11	Cyrillic	mockba	1	-	-	9	-	48	9	9	57	57
12	Cyrillic	opr	1	-	2	8	-	46	8	8	70	162
13	Devanagari	नेट	1	-	1	7	-	45	7	7	59	104
14	ASCII	etisalat	1	-	23	6	-	22	6	6	166	672
15	ASCII	next	1	-	3	5	-	19	5	5	39	96
16	ASCII	stcgroup	1	-	7	4	-	12	4	4	44	128
17	ASCII	smart	1	-	1	3	-	11	3	3	17	28
18	ASCII	rexroth	1	-	1	2	-	10	2	2	14	24
19	ASCII	ladbrokes	1	-	3	1	-	7	1	1	11	32
20	ASCII	land	1	-	7	0	-	-	-	-	-	-
Total			20	7	509				190	343	13,003	95,144

ICANN org noted that while the theoretical numbers may seem high, the number of comparisons in practice may be lower. For example, an Arabic string may not need to be compared with a string in a different script. The String Similarity Review Panel will presumably include language experts that can evaluate the visual similarities among strings and their variant labels based on their expertise and professional judgment.

Nevertheless, ICANN org noted that even if these theoretical numbers are not reached in practice, the Hybrid Model may introduce a significant level of complexity for implementation. Based on the numbers in **Illustration 3** above, the number of comparisons increases almost 38 fold from Level 2 to the Hybrid Model. As such, there is a high probability that the cost for conducting the String Similarity Review will increase, as the review will likely continue to be

¹⁸⁴ Read the ICANN org input on the hybrid model on pages 12, 15, and 16 in this document: <https://mm.icann.org/pipermail/gnso-epdp-idn-team/attachments/20221116/c1e0a14b/IDNEPDPICANNOrgInput-16Nov22-0001.pdf#page=12>

performed manually in the next application round.¹⁸⁵ As a consequence, those added costs will likely be passed onto applicants, given the cost recovery nature of the New gTLD Program.

In considering the benefit of the Hybrid Model, ICANN org agreed with the EPDP Team’s assessment that the effectiveness in mitigating the risk of confusion from denial of service/no-connection and misconnection will likely increase from Level 1 to Level 2, to the Hybrid Model, and to Level 3, acknowledging the Hybrid Model as a compromise between Level 2 and Level 3 in terms of implementation complexity.

As the ICANN org’s operational input did not provide new information that the EPDP Team did not already consider, the EPDP Team contemplated conducting a risk assessment of the two confusion risks – 1) denial of service/no-connection and 2) misconnection – to better understand whether the complexity of the Hybrid Model was commensurate with the level of the risks it aims to mitigate.¹⁸⁶ ICANN org support staff developed the risk assessment model reflected in **Illustrations 4-6** below. Specifically, the goal of the risk assessment model was to understand whether the “likelihood” and the “severity” of the two risks were significant enough to justify the increased implementation complexity of the Hybrid Model for String Similarity Review, as well as the added application evaluation costs that will likely be passed onto the applicants.

- **Illustration 4:** Suggested “likelihood” parameters to assess the two risks with examples to explain the numerical values.

Likelihood Rating		Description	Frequency (examples)	Scale (examples)
1	Minimal	Almost never occurs	A user almost never gets misled by domain names	Almost no user gets misled by domains names and incidences are rarely found anywhere
2	Low	Occur occasionally and in an isolated manner	A user gets misled by domain names only a couple of times and the incidences rarely repeat	Users in certain demographics get misled by domain names and the incidences are scattered
3	Medium	Occur several times and in a considerable manner	A user gets misled by domain names more than a few times and the incidences sometimes repeat	Users across several demographics get misled by domain names and many such incidents happen
4	High	Occur often and in an extensive manner	A user gets misled by domain names many times and the incidences often repeat	Users with diverse demographics get misled by domain names and the incidences happen in large scale
5	Maximal	Occur regularly and in a widespread manner	A user gets misled by domain names constantly and the incidences repeat regularly	Users all around the world get misled by domain names and the incidences are ubiquitous

¹⁸⁵ The EPDP Team noted that in the 2012 round, the evaluation results of the String Similarity Review were published later than originally scheduled (forecasted in November 2012, but results were not published until 26 February 2013). This delay was due to the volume of unique applied-for strings (1,380 unique applied-for strings resulted in over one million combinations requiring review). The evaluation results were released only two weeks before the deadline for filing String Confusion Objection, leaving limited time to prepare an objection.

¹⁸⁶ To learn more about the risk assessment model used by the EPDP Team, see the presentation slides, recording, and notes for meeting #63 <https://community.icann.org/x/PYYFDQ> on 22 December 2022 and meeting #64 <https://community.icann.org/x/X5E-DQ> on 5 January 2023.

- **Illustration 5:** Suggested “severity” parameters to assess the two risks with examples to explain the numerical values.

Severity Rating		Description	Privacy (examples)	Financial (examples)
1	Minimal	A user may encounter negligible inconveniences	<ul style="list-style-type: none"> • Potential in revealing personal identifying information (PII) by getting clickbaited 	<ul style="list-style-type: none"> • Potential in revealing banking / financial information
2	Low	A user may encounter few inconveniences, which may be overcome without any problem	<ul style="list-style-type: none"> • Email addresses and phone number leaked • Receive spam and phishing messages via email and phones 	<ul style="list-style-type: none"> • Tricked to purchase fraudulent / unwanted goods or services
3	Medium	A user may encounter significant inconveniences, which may be overcome despite a few difficulties	<ul style="list-style-type: none"> • Online account credentials leaked (e.g., access to email, social media, etc.) • Reputational damage 	<ul style="list-style-type: none"> • Debit / credit card fraud • Online shopping fraud • Denial of access to business services
4	High	A user may encounter significant consequences, which may be overcome albeit with serious difficulties	<ul style="list-style-type: none"> • Bank account theft • Biometric ID theft • Critical personal data / files theft 	<ul style="list-style-type: none"> • Misappropriation of funds • Property damage • Loss of employment • False incrimination
5	Maximal	A user may encounter significant, or even irreversible, consequences, which may not be overcome	<ul style="list-style-type: none"> • Serious identity theft (e.g., social security number, impersonation using stolen passport / ID cards.) 	<ul style="list-style-type: none"> • Bankruptcy • Life ruining debt • Loss of property

- **Illustration 6:** The EPDP Team was asked to pinpoint the risk levels in this matrix based on the numerical values assigned to “likelihood” and “severity” ratings.

	5	Medium / High	Medium / High	High	High	High
	4	Low / Medium	Medium / High	Medium / High	High	High
	3	Low / Medium	Low / Medium	Medium / High	Medium / High	High
Severity	2	Low	Low	Low / Medium	Low / Medium	Medium / High
	1	Low	Low	Low	Low / Medium	Low / Medium
		1	2	3	4	5
		Likelihood				

In the course of this discussion, the EPDP Team found it challenging to quantify the two risks, even with the understanding that the risk assessment model relied on individual professional judgment and not hard data. Members noted that the assessment of risk levels is highly subjective, as perceived risk levels may vary from person-to-person and also may depend on

other circumstances. For example, strings in certain scripts may have a higher risk of confusability compared to those in other scripts. It was also noted that the risk levels may change over time as more gTLD variant labels are introduced into the root zone. Some EPDP Team members felt that this risk assessment would be far less beneficial, given the absence (and non-existence) of data needed to formulate a reasonable judgment.

Considering the variability of risks and the difficulty in assessing risk levels, the EPDP Team agreed to put forward the Hybrid Model, as it is a sufficiently conservative approach. The EPDP Team also agreed that there may be scope for a more nuanced implementation for the Hybrid Model. This led the EPDP Team to support an exception to the Hybrid Model, which is that the String Similarity Review Panel may decide, based on guidelines and/or criteria to be developed during implementation, whether and what blocked variant label(s) to omit when conducting a comparison, specifically, where the scripts of such blocked variant labels exhibit a manifestly low level of visual confusability to each other.

8 Annex B – EPDP Team Charter

ICANN | GNSO

Generic Names Supporting Organization

WG Name:	TBD	
Section I: Working Group Identification		
Chartering Organization(s):	Generic Names Supporting Organization (GNSO) Council	
Charter Approval Date:	<Enter Approval Date>	
Name of WG Leadership:	<Enter Elected WG Leadership>	
Name(s) of Appointed Liaison(s):	<Enter Liaison>	
WG Workspace URL:	<Enter Active Project URL from GNSO Site>	
WG Mailing List:	<Enter Mailman archive link>	
GNSO Council Resolution:	Title:	Initiation of the Expedited Policy Development Process (EPDP) on the Internationalized Domain Names (IDNs)
	Ref # & Link:	<Enter Resolution link>
Important Document Links:	<p>Procedural Documents:</p> <ul style="list-style-type: none"> • Annex A-1: GNSO Expedited Policy Development Process • Expedited GNSO Policy Development Process Manual • GNSO Working Group Guidelines <p>Non Exhaustive List of Substantive Documents:</p> <ul style="list-style-type: none"> • GNSO New gTLD Subsequent Procedures Policy Development Process Final Report • IDN Variant TLD Implementation Staff Paper • Recommendations for the Technical Utilization of the RZ-LGR • RZ-LGR Project • Final Proposed Draft v. 4.0 of IDN Implementation Guidelines • Mapping Document - Charter Questions, SubPro Recommendations, and Prior IDN Efforts • GNSO Council IDN Scoping Team Final Report 	
Section II: Mission, Purpose, and Deliverables		
Mission & Scope:		

Background

On 14 March 2019, the ICANN Board approved a [set of recommendations](#) developed by ICANN org on how to allocate IDN variant TLD labels. The ICANN Board requested that the GNSO and ccNSO take into account those IDN variant TLD recommendations while developing their respective policies to define and manage IDN variant TLDs for the current TLDs and future TLD applications. The ICANN Board further requested that the GNSO and ccNSO keep each other informed of the progress in developing the relevant details of their policies and procedures to ensure a consistent solution for IDN variant gTLDs and IDN variant ccTLDs.

On 15 August 2019, the GNSO Council IDN Variants [Scoping Team](#) started to develop recommendations for the GNSO Council's consideration on how to address the IDN variant TLD recommendations. In addition, the Scoping Team also considered issues in the [Final Proposed Draft version 4.0 of Internationalized Domain Name \("IDN"\) Implementation Guidelines](#) ("IDN Guidelines v. 4.0"), for which the ICANN Board had [agreed](#) to the GNSO Council [request](#) to defer its adoption. Those issues pertain to the process/mechanism of updating the IDN Implementation Guidelines in general, as well as specific requirements within the IDN Guidelines v. 4.0. On 26 January 2020, the ICANN Board approved the [Recommendations for the Technical Utilization of the RZ-LGR](#) on how to employ the [RZ-LGR](#) to determine valid IDN TLDs and their variant labels. The ICANN Board requested that the GNSO and ccNSO take into account those RZ-LGR Technical Utilization recommendations while developing their respective policies to define and manage IDN variant TLDs for the current TLDs and future TLD applications.

At its meeting on 23 January 2020, the GNSO Council discussed the [Final Report](#) from the Scoping Team, which suggested tackling IDN related issues in two tracks: Operational Track and Policy Track. The Policy Track has two main objectives: i) to deliberate on the [definition](#) and [management](#) of IDN variant TLDs, and ii) to deliberate on the change process of the IDN Guidelines and any policy issues related to the IDN Guidelines v. 4.0 identified by the Operational Track Team (consisted of members in the GNSO Contracted Parties House) and agreed upon by the IDN Guidelines Working Group.

In considering the mechanism in carrying out the Policy Track work on IDNs, the GNSO Council agreed with the Scoping Team's suggestion that an Issue Report is likely not needed in order to initiate the work, and an EPDP is the desired approach. Hence, during its meeting on 21 October 2020, the GNSO Council agreed to establish a [Drafting Team](#) to develop both a draft charter and an Initiation Request for an EPDP on IDNs. The Drafting Team kicked off its meetings on 8 December 2020 and submitted the draft EPDP charter and the Initiation Request for the GNSO Council's consideration on 10 May 2021.

At its meeting on 20 May 2021, the GNSO Council resolved to initiate an Expedited Policy Development Process ("EPDP") on IDNs and adopted this charter for the EPDP Team to deliberate the Policy Track issues outlined below.

Scope & Charter Questions

This EPDP is expected to provide the GNSO Council with policy recommendations on:

- i) the definition of all TLDs and the management of variant labels to facilitate the delegation of variant gTLDs in the root zone while achieving the security and usability goal of variant labels in a stable manner; and
- ii) how the IDN Implementation Guidelines, which Contracted Parties are required to comply with, should be updated in the future.

Notwithstanding the former and subject to GNSO Council approval, the mission and scope of this EPDP may be expanded specifically as a result of the Operational Track. This EPDP is expected to provide the GNSO Council with recommendations to resolve issues for policy considerations in the IDN Implementation Guideline 4.0, IF and WHEN such issues are identified by the Operational Track Team and agreed to by the IDN Guidelines Working Group.

The WG is expected to develop its recommendations by building on the existing body of policy work, research, and analysis on the IDN subject, with a focus on the [GNSO New gTLD Subsequent Procedures \(SubPro\) PDP recommendations](#) under Topic 25 on IDNs and other relevant topics, which have been adopted by the GNSO Council in February 2021 and forwarded to the ICANN Board for adoption.

The SubPro PDP recommendations were developed by taking into account other previous policy work on IDNs, including the [IDN Variant TLD Implementation staff paper](#) (“Staff Paper”) and [Recommendations for the Technical Utilization of the Root Zone Label Generation Rules \(RZ-LGR\)](#) (“TSG recommendations”). See more information about the previous work on IDNs in [Appendix B](#) of the IDN Variants Scoping Team Final Report.

As a result, the charter questions were developed based on the following principles and framework:

- This WG should not revisit SubPro recommendations in the context of future new gTLDs, but will consider questions asking whether such recommendations should be extended to existing gTLDs;
- Where SubPro does not have a recommendation that corresponds to the Staff Paper/TSG recommendation, the charter will include questions about the impact of such recommendations on both future and existing gTLDs;
- The SubPro Implementation Review Team (IRT) and this WG (including its future IRT) should coordinate on addressing implementation issues to achieve, to the extent possible, consistent solutions for new and existing gTLDs. To be clear, coordination does not mean that this WG cannot independently consider certain question that impact both future and existing TLDs or arrive at its own conclusion, but means that whichever group is first to develop a solution or recommendation for such question, such group should inform the other group to ensure a consistent implementation can be developed to the extent possible.

To see whether/how the SubPro PDP recommendations map to the recommendations developed in previous policy work on IDNs, reference the [mapping document](#), which also provides context to the corresponding charter questions.

This charter recognizes that the existing policy efforts seek to address the challenge of achieving security and usability goals for IDN variants in a stable manner. As such, the SubPro PDP, Staff Paper, and TSG designed their recommendations to be conservative and to find a balance to permit delegation of TLD variant labels that meet end user needs but block TLD variant labels that pose a security risk to end users.

This charter also recognizes the processes established by the SubPro PDP and the inclusion of questions related to the SubPro PDP’s recommendations is not intended to amend the structure or framework of those processes but rather, to ensure that they are able to properly accommodate variant domain names and incorporate the same entity principle for existing and future gTLDs.

As part of this determination, the WG is, at a minimum, expected to consider the following elements and answer the following charter questions.

TLD Label Validation and Variant Label(s) Calculation

A. Consistent definition and technical utilization of RZ-LGR:

The Charter recognizes that RZ-LGR related recommendations that the following questions seek to address were

developed with the aim to achieve the security and usability goals for variant labels in a stable manner and were designed to be conservative, with the view that the IDN variant TLDs are being implemented for the first time.

a1) Evaluating all TLDs using RZ-LGR as the one and only authoritative source allows for a consistent approach for reviewing current and future TLDs. The SubPro PDP, the Staff Paper, and the Study Group on Technical Use of RZ-LGR (“TSG”) recommend that compliance with RZ-LGR (RZ-LGR-4, and any future RZ-LGR versions) must be required for the validation of all future gTLDs (including IDN and ASCII labels) and the calculation of their variant labels as a matter of policy, including the determination of whether the disposition of the label should be blocked or allocatable.¹⁸⁷

For existing delegated gTLD labels, does the WG recommend using the RZ-LGR as the sole source to calculate the variant labels and disposition values?

a2) Before the proposed RZ-LGR mechanism, applications for IDN gTLDs have asked the applicant to identify and list any variant labels (based on their own calculations) corresponding to the applied-for string. The self-identified “variant” labels do not have legal standing, as “[d]eclaring variant strings is informative only and will not imply any right or claim to the declared variant strings.”¹⁸⁸ The TSG recommends that the self-identified “variant” labels which are also variant labels calculated by RZ-LGR will need to be assigned a variant disposition based on RZ-LGR calculation, as discussed in **a1)**.

If some self-identified “variant” TLD labels by the former gTLD applicants are not found consistent with the calculation of the RZ-LGR, but have been used to certain extent (e.g., used to determine string contention sets), how should such labels be addressed in order to conform to the LGR Procedure and RZ-LGR calculations? Consider this question by taking into account the data to be collected in the “Data and Metric Requirements” section of this charter.

a3) SubPro PDP recommends that ICANN establish a mechanism that allows specific parties to challenge or appeal certain types of actions or inactions that appear to be inconsistent with the Applicant Guidebook.¹⁸⁹ SubPro PDP recommends that such a limited challenge/appeal mechanism applies to several types of evaluations and formal objections decisions, including the DNS Stability aspect of evaluation/challenge procedures. Previously, both the SSAC and TSG also recommended a challenge process for resolving disagreement with the RZ-LGR calculation on certain strings.¹⁹⁰

If an applied-for TLD label, whose script is supported by the RZ-LGR, is determined to be “invalid”, is there a reason NOT to use the evaluation challenge processes recommended by SubPro? If so, rationale must be clearly stated. If SubPro’s recommendation on the evaluation challenge process should be used, what are the criteria for filing such a challenge? Should any additional specific implementation guidance be provided, especially pertaining to the challenge to the LGR calculation as it can have a profound, decimating impact on the use of RZ-LGR?¹⁹¹

a4) For future gTLD applications, the SubPro PDP proposes an implementation guidance that if a script is not yet integrated into the RZ-LGR, applicants should be able to apply for a string in that script, and it should be processed up to but not including contracting.¹⁹² Applicants under such circumstances should be warned of the possibility that the applied-for string may never be delegated and they will be responsible for any additional evaluation costs. The burden in this case is on the applicant, who may have to wait for an indeterminate amount of time but is not aware of any other serious concerns. The SubPro PDP developed this implementation guidance by taking into consideration the TSG recommendation that the application should remain on-hold (or other appropriate status) until the relevant script is integrated into the RZ-LGR.¹⁹³

The WG and the SubPro IRT to coordinate and consider the following questions in order to develop a consistent solution: should the SubPro recommendation be extended to existing TLDs that apply for a variant TLD label whose script is not yet supported by the applicable version of the RZ-LGR? Consider this question in tandem with **b4)** and by taking into account the data to be collected in the “Data and Metric Requirements” section of this charter. If not, what should be the process for an existing TLD registry who wishes to apply for a variant TLD label whose script is not yet supported by the applicable version of the RZ-LGR?

a5) SAC060 notes that variant code points in LGR may introduce a “permutation issue”, possibly creating a large number of variant domain names, which “presents challenges for the management of variant domains at the registry, the registrar and registrant levels.”¹⁹⁴ SAC060 advises that “ICANN should ensure that the number of strings that are activated is as small as possible.” The TSG agreed with this SSAC advice.¹⁹⁵ Appendix C of the Staff Paper reviewed the factors causing numerous variant labels and suggested measures to address this issue.¹⁹⁶

Should there be a ceiling value or other mechanism to ensure that the number of delegated top-level variant labels remains small, understanding that variant labels in the second level may compound the

¹⁸⁷ See Recommendation 25.2 and Implementation Guidance 26.10 in the SubPro Final Report, pp.115, 119:

<https://gnso.icann.org/sites/default/files/file/field-file-attach/final-report-newgtld-subsequent-procedures-pdp-02feb21-en.pdf#page=115>; Recommendation 1 in the Staff Paper, p.3:

<https://www.icann.org/en/system/files/files/idn-variant-tld-recommendations-analysis-25jan19-en.pdf#page=3>;

Recommendation 1 in the TSG report, p.5: <https://www.icann.org/en/system/files/files/rz-lgr-technical-utilization-recs-07oct19-en.pdf#page=5>

¹⁸⁸ For more details see *gTLD Applicant Guidebook*, version 2012-06-04, section 1.3.3 IDN Variant TLDs, p.1-35:

<https://newgtlds.icann.org/en/applicants/agb/guidebook-full-04jun12-en.pdf>

¹⁸⁹ See Recommendation 32.1 in the SubPro Final Report, pp.154-155:

<https://gnso.icann.org/sites/default/files/file/field-file-attach/final-report-newgtld-subsequent-procedures-pdp-02feb21-en.pdf#page=154>

¹⁹⁰ Disagreement with the LGR calculator may arise due to circumstances including but not limited to: an invalid label due to choice of "letter" not included in the repertoire, albeit being IDNA2008 protocol-valid; an invalid label due to a contextual or whole label evaluation rule imposed by either integration or generation panels' variant; labels differ because of different assumptions. SAC060 proposed a straw man process to resolve disputes to the RZ-LGR results. The TSG recommended several technical inputs be considered when developing the resolution mechanism. See Recommendation 2, SAC060, p.9:

<https://www.icann.org/en/system/files/files/sac-060-en.pdf#page=9>; see

Recommendation 4 in the TSG Report, pp.6-7: <https://www.icann.org/en/system/files/files/rz-lgr-technical-utilization-recs-07oct19-en.pdf#page=6>

¹⁹¹ Any changes in RZ-LGR brought about by a process outside the LGR Procedure would invalidate the RZ-LGR and thus the definition of the variant TLD, as stated in the LGR Procedure. TSG suggests how to address such a challenge by remaining within the LGR Procedure.

¹⁹² See Implementation Guidance 25.3 in the SubPro Final Report, p.115:

<https://gnso.icann.org/sites/default/files/file/field-file-attach/final-report-newgtld-subsequent-procedures-pdp-02feb21-en.pdf#page=115>

¹⁹³ It is important to recognize that the RZ-LGR can be updated to include additional scripts as long as it is done in compliance with the LGR Procedure. The practical limitation, however, is that the time to create an LGR script proposal varies greatly (i.e. months or years). See Recommendation 5 in the TSG report, p.7:

<https://www.icann.org/en/system/files/files/rz-lgr-technical-utilization-recs-07oct19-en.pdf#page=7>; for additional

context and rationale, see Appendix A of the Recommendations for Technical Utilization of RZ-LGR, pp.11-12:

<https://www.icann.org/en/system/files/files/rz-lgr-technical-utilization-recs-07oct19-en.pdf#page=11>

¹⁹⁴ See Recommendation 14, SAC060, p. 20: <https://www.icann.org/en/system/files/files/sac-060-en.pdf#page=20>

¹⁹⁵ See Recommendation 6 in the TSG report, p.7: <https://www.icann.org/en/system/files/files/rz-lgr-technical-utilization-recs-07oct19-en.pdf#page=7>

¹⁹⁶ See Appendix C of the IDN Variant TLD Implementation: Appendices, pp. 12-29:

<https://www.icann.org/en/system/files/files/idn-variant-tld-appendices-25jan19-en.pdf#page=12>

situation? Should additional security and stability guidelines be developed to make variant domains manageable at the registry, registrar, and registrant levels?¹⁹⁷

a6) Since RZ-LGR can be updated over time, the WG needs to consider the implications for existing TLD labels and their variant labels (if any), including any potential changing of status or disposition value.¹⁹⁸ The TSG further recommends that the Generation Panel (GP) must call out the exception where an existing TLD is not validated by their proposed solution during the public comment period and explain the analysis and reasons for not supporting the existing TLD in their script LGR proposal.¹⁹⁹ This will allow the community and the GP to review such a case to confirm that an exception is indeed warranted.

Does the WG agree with TSG's suggested approach? If so, to what extent should the TLD policies and procedures be updated to allow an existing TLD and its variants (if any), which are not validated by a script LGR, to be grandfathered? If not, what is the recommended approach to address changes to the current version of the RZ-LGR that assign different disposition values to existing TLDs? Consider this question by taking into account the data to be collected in the "Data and Metric Requirements" section of this charter.

a7) The SubPro PDP recommends that single character gTLDs may be allowed for limited script/language combinations where a character is an ideograph (or ideogram) and do not introduce confusion risks that rise above commonplace similarities, consistent with SAC052 and Joint ccNSO-GNSO IDN Workgroup (JIG) report.²⁰⁰

What mechanism or criteria should be used to identify the scripts/languages appropriate for single-character TLDs? Once those scripts/languages are identified, what mechanism or criteria should be used to identify a specific list of allowable characters which can be used as a single-character TLD within such scripts/languages? Should any specific implementation guidance be provided?

Furthermore, should the relevant GP tag these code points in the RZ-LGR for a consistent analysis and to ease their identification and algorithmic calculation?²⁰¹

a8) What additional aspects of gTLD policies and procedures, which are not considered in the above charter questions, need to be updated to ensure that the validation of existing TLD labels and

¹⁹⁷ One of the security and stability concerns is that some scripts can generate large numbers of variants based on the way the LGR works. The RZ-LGR Procedure manages such numbers by minimizing allocatable variant labels and maximizing blocked variant labels. However, though this approach is optimal in most cases, the outcome may be worse for a specific label in some cases.

¹⁹⁸ See Recommendation 7 in the TSG report, p.8: <https://www.icann.org/en/system/files/files/rz-lgr-technical-utilization-recs-07oct19-en.pdf#page=8>

¹⁹⁹ See Recommendation 12 in the TSG report, p.9: <https://www.icann.org/en/system/files/files/rz-lgr-technical-utilization-recs-07oct19-en.pdf#page=9>

²⁰⁰ See Recommendation 25.4 in the SubPro PDP Final Report, p.115: <https://gnso.icann.org/sites/default/files/file/field-file-attach/final-report-newgtld-subsequent-procedures-pdp-02feb21-en.pdf#page=115>; Recommendation 1 in SAC052, p.8: <https://www.icann.org/en/system/files/files/sac-052-en.pdf#page=8>; the SubPro PDP does not believe it has the relevant expertise to make this determination and would welcome the identification of the limited set of scripts and languages and potentially a specific list of allowable single-characters (e.g., during implementation), which will substantially increase the predictability of what will likely still remain a case-by-case, manual process. See Rationale for Recommendation 25.4 in the SubPro PDP Final Report, pp.116-117: <https://gnso.icann.org/sites/default/files/file/field-file-attach/final-report-newgtld-subsequent-procedures-pdp-02feb21-en.pdf#page=116>

²⁰¹ See Annex B of the Recommendations for the Technical Utilization of the RZ-LGR, p.13: <https://www.icann.org/en/system/files/files/rz-lgr-technical-utilization-recs-07oct19-en.pdf#page=13>

calculation of variant labels depend exclusively on the RZ-LGR in a consistent manner?

a9) A given label in an Internationalized Domain Label (IDL) set may be in one of the following non-exhaustive status: delegated, withheld-same-entity, blocked, allocated, rejected. The WG and the SubPro IRT to coordinate and develop a consistent definition of variant label status in the IDL set.

a10) Individual labels in an IDL set may go through the following possible status transformations:

- **from “withheld-same-entity” to “allocated”**: Allocation only to the same entity as another label in the IDL set. This change happens if a variant was not initially requested for allocation and later is. Allocating withheld labels would be the application process for a variant TLD.
- **from “blocked” to “withheld-same-entity”**: A later LGR may broaden the available labels in the IDL set. Such possible labels automatically become withheld-same-entity.
- **from “allocated” to “delegated”**: Happens when name servers are added. (Not new.)
- **from “delegated” to “allocated”**: If a domain is removed from the DNS, the allocation can remain in place anyway. Rare in the root zone, but not new.
- **from “rejected” to “withheld-same-entity”**: Every Rejected label is automatically Withheld-same-entity as well. If the Rejected status comes off, the label can be handled as any other Withheld-same-entity label.

Note that an allocated or withheld-same-entity label cannot become blocked unless a new version of the LGR makes this possible.

The WG and the SubPro IRT to coordinate and consider the following questions in order to develop a consistent solution: what is the procedure to change the label status for individual variant labels?

IDN Variant TLD Management

B. “Same entity” at the top-level

b1) Both the SubPro PDP and the Staff Paper recommend that variant TLDs that ICANN delegates must have the “same entity” as the sponsoring organization and the “Registry Operator” be used as the definition of the “same entity” at the top-level.²⁰²

Should this recommendation be extended to existing TLDs?

b2) Both the SubPro PDP and the Staff Paper recommend that variant TLDs be operated by the same back-end registry service provider, the organization providing one or more registry services (e.g., DNS, DNSSEC, RDDS, EPP) for a registry operator.²⁰³

Should this recommendation be extended to existing TLDs and their variant TLD labels?

b3) Beyond having the same Registry Operator and same back-end registry service provider, as referenced in b1) and b2), is there a need for additional constraints for the same entity requirement for the top-level?²⁰⁴ If so, the rationale must be clearly stated.

b4) The policy recommendation advises that variant TLD labels be allocated to the same entity, however a process to apply for a variant TLD does not exist. The WG and the SubPro IRT to coordinate and consider the following questions in order to develop a consistent solution: what should an application process look like in terms of timing and sequence for an existing and future Registry Operator with respect to applying or activating their allocatable variant TLD labels?

b4a) For the variant labels with status “withheld for the same entity” (i.e. not requested for allocation in the application process), what role do they play?

b5) Do restrictions that apply to a TLD (e.g., community TLDs, dot brand TLDs) also apply to its variants? Are these labels equally treated as different versions of the same string, or completely independent strings not bound by the same restrictions?

C. “Same entity” at the second-level:

c1) Both the SubPro PDP and the Staff Paper recommend that: 1) a given second-level label beneath each allocated variant TLD must have the “same entity”; and 2) all allocatable second-level IDN variant labels that arise from a registration based on a second-level IDN table must have the “same entity”.²⁰⁵ Should this recommendation be extended to existing second-level labels?

c2) Currently Registry Operators may activate the IDN variant labels at the second-level when requested by the sponsoring Registrar of the canonical name as described in the IDN Tables and IDN Registration Rules.²⁰⁶ Both the SubPro PDP and the Staff Paper recommend that at the second-level, the same entity definition can be achieved by ensuring that the registrant is the same.²⁰⁷ Should this recommendation be extended to the already activated IDN variant labels at the second-level? How does the “same entity” requirement impact the current rules for Registry Operators for activating IDN variant labels?

²⁰² See Recommendation 25.5 in the SubPro PDP Final Report, p.115:

<https://gnso.icann.org/sites/default/files/file/field-file-attach/final-report-newgtld-subsequent-procedures-pdp-02feb21-en.pdf#page=115>; Recommendation 2 in the Staff Paper, p.3:
<https://www.icann.org/en/system/files/files/idn-variant-tld-recommendations-analysis-25jan19-en.pdf#page=3>;

rationale for Recommendation 25.5 in the SubPro PDP Final Report, p.117:

<https://gnso.icann.org/sites/default/files/file/field-file-attach/final-report-newgtld-subsequent-procedures-pdp-02feb21-en.pdf#page=117>; Section 3.2 in the Staff Paper, pp.6-7: <https://www.icann.org/en/system/files/files/idn-variant-tld-recommendations-analysis-25jan19-en.pdf#page=6>

²⁰³ See Recommendation 25.5 in the SubPro PDP Final Report, p.115:

<https://gnso.icann.org/sites/default/files/file/field-file-attach/final-report-newgtld-subsequent-procedures-pdp-02feb21-en.pdf#page=115>; Recommendation 7 in the Staff Paper, p.4:
<https://www.icann.org/en/system/files/files/idn-variant-tld-recommendations-analysis-25jan19-en.pdf#page=4>

²⁰⁴ The initial set of IDN variant TLD management recommendations proposed for public comment also required that the IDN variant TLDs be implemented using the same nameservers, unless otherwise justified. However, that recommendation is now removed based on the feedback received by the community asking for more operational flexibility in the implementation of IDN variant TLDs.

²⁰⁵ See Recommendation 25.6 in the SubPro PDP Final Report, p.116:

<https://gnso.icann.org/sites/default/files/file/field-file-attach/final-report-newgtld-subsequent-procedures-pdp-02feb21-en.pdf#page=116>; Recommendation 3 in the Staff Paper, p.3:
<https://www.icann.org/en/system/files/files/idn-variant-tld-recommendations-analysis-25jan19-en.pdf#page=3>;
Recommendation 25.7 in the SubPro PDP Final Report, p.116: <https://gnso.icann.org/sites/default/files/file/field-file-attach/final-report-newgtld-subsequent-procedures-pdp-02feb21-en.pdf#page=116>; Recommendation 4 in the Staff Paper, p.4: <https://www.icann.org/en/system/files/files/idn-variant-tld-recommendations-analysis-25jan19-en.pdf#page=4>

²⁰⁶ See Section 2.2 in the “Standard Amendment Language, Add Internationalized Domain Names (IDNs) - May Activate Variants” here: <https://www.icann.org/en/system/files/files/standard-amendment-language-add-idns-may-activate-variants-14jun19-en.pdf>

²⁰⁷ See Rationale for Recommendation 25.6-25.8 in the SubPro PDP Final Report, pp.117-118:

<https://gnso.icann.org/sites/default/files/file/field-file-attach/final-report-newgtld-subsequent-procedures-pdp-02feb21-en.pdf#page=117>; Section 3.2.1 in the Staff Paper, p.7: <https://www.icann.org/en/system/files/files/idn-variant-tld-recommendations-analysis-25jan19-en.pdf#page=7>

c3) The WG and the SubPro IRT to coordinate and consider the following question in order to develop a consistent solution: what is the appropriate mechanism to identify the registrant as the “same entity” at the second-level for future and existing labels?

The Staff Paper recommends using ROID to ensure that the same label beneath all variant labels is allocated to the same entity.²⁰⁸ However, some registrars in practice may not reuse contact objects for different registrations by the same registrant, and there is no existing data on the number/percentage of ICANN accredited registrars that reuse contact ROID.²⁰⁹

Is ROID a reasonable mechanism to determine the same registrant at the second-level for both future and existing labels? If not, what mechanism/functional definition can be used to ensure the second-level variant labels are allocated to the same entity for both current and future TLDs? Consider this question by taking into account the data to be collected in the “Data and Metric Requirements” section of this charter.

c3a) If the Working Group determines to use ROID as the mechanism to identify the registrant as the “same entity” at the second-level, are there additional requirements to ensure the “same entity” principle is followed?²¹⁰

c4) A registry TLD may offer registrations using different IDN tables to support different languages or scripts.²¹¹ In case multiple IDN tables are offered, IDN tables should produce a consistent set of second-level variant labels to help achieve the security and usability goals for managing variant labels in a stable manner, promoting a good user experience.²¹²

As such, the Staff Paper recommends that IDN tables of variant TLDs be mutually coherent, i.e. any two code points (or sequences) that are variants in TLD ‘t1’ cannot be non-variants in variant TLD ‘t1v1’.²¹³ This recommendation also implies that any two code points (or sequences) that are variants in IDN

²⁰⁸ Besides ROID, the Staff Paper also includes additional options to achieve the “same entity” requirement: having all the registrant fields be the same (without considering the ROID) for both names; having a core subset of the registrant fields be the same (without considering the ROID) for both names; or requiring a cryptographic probe that both registrants are indeed the same. See Section 3.2.1 in the Staff Paper, p.7:

<https://www.icann.org/en/system/files/files/idn-variant-tld-recommendations-analysis-25jan19-en.pdf#page=7>

²⁰⁹ If a large portion of registrars do not reuse contact objects (ROID) for registrant, then changing the status quo would be a major development undertaking for a potentially small market for variants. Note that for interoperability virtually all registrars would need to support the same “glue” method to support inter-registrar transfers.

²¹⁰ If the same contact ROID or functional equivalent is used to identify registrants, no registrant metadata syncing is needed, as the registrant metadata is automatically the same for all registrants of every allocated variant based on ROID. This also means that issues around privacy and proxy services are addressed, because the privacy or proxy service must still generate a contact ROID (or its functional equivalent) for the registrant. However, the Staff Paper notes that if a registration system does not use contact objects, a requirement about registrant metadata syncing will be needed to ensure the “same entity” rule. See Section 3.9.1 in the Staff Paper, p.22:

<https://www.icann.org/en/system/files/files/idn-variant-tld-recommendations-analysis-25jan19-en.pdf#page=22>

²¹¹ Registry TLD refers to a single TLD in a RA, not the Registry Operator which may operate one or more TLDs.

²¹² See “Motivation, Premises, and Framework” section of the Staff Paper:

<https://www.icann.org/en/system/files/files/idn-variant-tld-motivation-premises-framework-25jan19-en.pdf>

²¹³ The intent of the recommendation is that a given TLD’s IDN tables be harmonized, not all of the Registry Operator’s IDN tables for all the TLDs it operates, but with exception of variant TLDs that the Registry Operator also operates. See Recommendation 5 in the Staff Paper, p.4: <https://www.icann.org/en/system/files/files/idn-variant-tld-recommendations-analysis-25jan19-en.pdf#page=4>

Table A for TLD t2, which does not have any variant TLD, cannot be non-variants in another IDN Table B for the same TLD t2.²¹⁴

Should the second-level IDN tables offered under a TLD, including IDN variant TLDs, be required to be mutually coherent? If yes, how should existing registrations which may not meet the “mutually coherent” requirement of second-level IDN tables be addressed? Rationale must be clearly stated.

c4a) Notwithstanding that IDN tables need to be mutually coherent, the SubPro PDP and the Staff Paper recommend that the set of allocatable or activated second-level variant labels may not be identical across the activated IDN variant TLDs. Meaning, their behavior/disposition can be different.²¹⁵

Under the conditions above, may the set of allocatable or activated second-level variant labels not behave identically under an individual TLD, which does not have any variant TLD label?

c5) There is existing practice by registries to harmonize IDN tables, but there is no data on the various methods they may have used. The Staff Paper suggests maintaining a common set of harmonized second-level IDN tables for all IDN variant TLDs and then (a) choosing all these IDN tables to offer for all IDN variant TLDs, or (b) choosing a relevant different subset of IDN tables to offer for each different IDN variant TLD.²¹⁶

The WG and the SubPro IRT to coordinate and consider the following question in order to develop a consistent solution: are the above suggested methods in the Staff Paper sufficient for IDN table harmonization purposes? Should any additional implementation guidance be provided for a registry?

c6) To facilitate the harmonization of IDN tables, the Staff Paper recommends that IDN tables for the second-level be formatted in the machine readable LGR format specified in RFC 7940, Representing Label Generation Rulesets Using XML.²¹⁷ However, each Registry Operator can harmonize the IDN tables today via software development solutions or are already in process of doing so.

The WG and the SubPro IRT to coordinate and consider the following question in order to develop a consistent solution: should Registry Operators be required to use the machine readable LGR format as specified in RFC 7940 for their second-level IDN tables? Or should Registry Operators have the flexibility to resolve the harmonization issue so long as it can predictably and consistently produce the same variant labels, albeit with different disposition values, across the same-script IDN tables?

Consider this question by taking into account the data to be collected in the “Data and Metric Requirements” section of this charter.

²¹⁴ The Staff Paper does not explicitly make such recommendation with respect to a given TLD that does not have variants, but the proposed IDN Implementation Guidelines 4.0 recommends such.

²¹⁵ See Recommendation 25.8 in the SubPro PDP Final Report, p.116: <https://gnso.icann.org/sites/default/files/file/field-file-attach/final-report-newgtld-subsequent-procedures-pdp-02feb21-en.pdf#page=116>; Recommendation 6 in the Staff Paper, p.4: <https://www.icann.org/en/system/files/files/idn-variant-tld-recommendations-analysis-25jan19-en.pdf#page=4>

²¹⁶ See Section 3.5.1 in the Staff Paper, p.14: <https://www.icann.org/en/system/files/files/idn-variant-tld-recommendations-analysis-25jan19-en.pdf#page=14>

²¹⁷ See RFC 7940 here: <https://www.rfc-editor.org/info/rfc7940>; Section 3.3.1 in the Staff Paper, pp.9-10: <https://www.icann.org/en/system/files/files/idn-variant-tld-recommendations-analysis-25jan19-en.pdf#page=9>

D. Adjustments in registry agreement, registry service, registry transition process, and other processes/procedures related to the domain name lifecycle:

d1) The same entity principle for variant TLDs -- having the same registry operator and the same back-end registry service provider for gTLD and its variant labels at the top-level -- needs to be effectuated legally and operationally.

From a legal standpoint there will be a binding document(s) between ICANN and the registry operator (e.g., Registry Agreement), which should memorialize the relationship between each allocated TLD and its variant labels, as well as the obligations to maintain such condition during the life of the contract(s). From an operational standpoint, an application process, testing of registry services, fee structure, and other aspects need to be defined and developed.

The EPDP should discuss and develop the proper legal and operational framework in order to strike a balance between conservatism, innovation, adoption and other aspects of the IDN implementation. The WG and the SubPro IRT to coordinate and consider the following questions in order to develop a consistent solution:

d1a) A TLD is subject to a Registry Agreement with ICANN. In case of IDN variant TLDs, ICANN would execute the Registry Agreement with the same entity but potentially diverge in future Registry Agreement amendments, addendums, and renewals. Should each TLD label be the subject of a separate Registry Agreement with ICANN?²¹⁸ If not, should each TLD label along with its variant labels be subject to one Registry Agreement with the same entity? Rationale for such definition must be clearly stated along with the answer, including goals and motivations.

d1b) What should be the process by which an existing registry operator could apply for, or be allocated, a variant for its existing gTLD? What should be the process by which an applicant applying for a new IDN gTLD could seek and obtain any allocatable variant(s)? What should be the associated fee(s), including the application fees and annual registration fees for variant TLDs? Should any specific implementation guidance be provided?²¹⁹

d2) In order to ensure that the same entity principle is maintained for a gTLD and its allocated variant TLD labels, what are the operational and legal impacts to the:

²¹⁸ Based on the premise that an IDN variant TLD label is a TLD label with its status indistinguishable from any other TLD label in the root zone, the Staff Paper recommends that each variant TLD would be the subject of a separate Registry Agreement with ICANN, as each variant TLD is, in effect, one a TLD. See Section 3.6 in the Staff Paper, p.15: <https://www.icann.org/en/system/files/files/idn-variant-tld-recommendations-analysis-25jan19-en.pdf#page=15>

²¹⁹ SubPro PDP did not have substantive discussion about this question. Some SubPro PDP members believe that allocatable variant TLDs should be made available to IDN gTLD registry operators and applicants, with only limited procedures and costs in place. As these deliberations arose late in the SubPro PDP's life cycle, the group elected to only recommend the "same entity" principle for variant TLDs but refrained from providing recommendations on how variant TLDs can be obtained. However, SubPro includes in its recommendation that the "same entity" policy for the top-level must be captured in the relevant Registry Agreement. See Rationale for Recommendation 25.5 in the SubPro PDP Final Report, p.117: <https://gns0.icann.org/sites/default/files/file/field-file-attach/final-report-newgtld-subsequent-procedures-pdp-02feb21-en.pdf#page=117> and Recommendation 25.5 in the SubPro PDP Final Report, p.115: <https://gns0.icann.org/sites/default/files/file/field-file-attach/final-report-newgtld-subsequent-procedures-pdp-02feb21-en.pdf#page=115>

- Registry Transition Process or Change of Control in the Registry Agreement;²²⁰
- Emergency Back-End Registry Operator (EBERO) provisions; and
- Reassignment of the TLD as a result of the Trademark Post-Delegation Dispute Resolution Procedure (TM-PDDRP)?²²¹

d3) In order to ensure that the same entity principle is maintained, what are the operational and legal impacts to the data escrow policies, if any.²²²

d4) Regarding second-level domain names, should a variant set behave as one unit, i.e. the behavior of one domain name is replicated across the other variant domain names? Or should each variant domain name have its own independent domain name life cycle?²²³ Consider the operational and legal impact of the “same entity” principle, if any, to all aspects of a domain name lifecycle, including but not limited to:

- Registration, including registration during the Sunrise Period, any Limited Registration Period,

²²⁰ The Staff Paper recommends that each set of registry agreement(s) must contain provisions requiring all the labels in the Internationalized Domain Label (IDL) set to follow the same process in the event of any registry transition via a Registry Transition Process or Change of Control. In no event, should the composition of the allocated and delegated set of variant TLDs be allowed to change at the same time as the change of the Registry Operator. The SubPro PDP also agrees that to the extent that the TLD were to change hands at any point after delegation, the variant TLDs must remain linked contractually, which should be considered a persistent requirement (e.g., this would impact gTLD registry transition procedures). See Section 3.6 in the Staff Paper, p.15:

<https://www.icann.org/en/system/files/files/idn-variant-tld-recommendations-analysis-25jan19-en.pdf#page=15> and Rationale for Recommendation 25.5 in the SubPro PDP Final Report, p.117:

<https://gnso.icann.org/sites/default/files/file/field-file-attach/final-report-newgtld-subsequent-procedures-pdp-02feb21-en.pdf#page=117>

²²¹ The Staff Paper recommends that an emergency transition of a TLD to an EBERO must trigger an emergency transition of all variant TLDs to the EBERO. In addition, the SubPro PDP also agrees that EBERO would be impacted due to the persistent requirement of ensuring that variant TLDs must remain linked contractually. See Section 3.6 in the Staff Paper, p.16: <https://www.icann.org/en/system/files/files/idn-variant-tld-recommendations-analysis-25jan19-en.pdf#page=16> and Rationale for Recommendation 25.5 in the SubPro PDP Final Report, p.117:

<https://gnso.icann.org/sites/default/files/file/field-file-attach/final-report-newgtld-subsequent-procedures-pdp-02feb21-en.pdf#page=117>. In the case where a Registry Agreement is terminated as a result of a TM-PDDRP

determination, this would trigger the Registry Transition Procedure and various outcomes could apply. The Staff Paper notes that in the case of a reassignment of the TLD, the “same entity” rule should continue to apply so that the variant TLDs would be assigned to the same entity together. See Section 3.7 in the Staff Paper, p.18:

<https://www.icann.org/en/system/files/files/idn-variant-tld-recommendations-analysis-25jan19-en.pdf#page=18>

²²² Data escrow is the act of storing data with a neutral third party in case of registry or registrar failure, accreditation termination, or accreditation relapse without renewal. ICANN requires all registrars and gTLD registries to contract with a data escrow provider in order to safeguard registrants. Because each variant of the IDL set is just another registration, data escrow policies for TLDs apply individually to each. The Staff Paper notes that the data escrow requirements are automatically satisfied for variant TLDs. See Section 3.9.2 in the Staff Paper, p.22:

<https://www.icann.org/en/system/files/files/idn-variant-tld-recommendations-analysis-25jan19-en.pdf#page=22>

²²³ One view is that if each variant allocation is simply a different registration, it follows that names can be created and can expire at different times, despite the “same-entity” rule. See Section 3.9.4 in the Staff Paper, p.22:

<https://www.icann.org/en/system/files/files/idn-variant-tld-recommendations-analysis-25jan19-en.pdf#page=22>.

Another view is that if each variant allocation is supposed to be the same registration, it follows that names should expire at the same time, however some registry operators may implement it differently and consider them billable transactions instead.

any Launch Program and during General Registration

- Update
- Renewal
- Transfer
- Lock
- Suspension
- Expiration
- Redemption
- Deletion

d5) For reporting and fee accrual purposes, should each variant domain name be considered an independent registration? Or should such variant labels be considered as an atomic set (irrespective of whether any of the names is actually activated in the DNS, and whether any of the variants is actually registered)? Rationale for such definition must be clearly stated. Should any specific implementation guidance be provided? For example, what would be the impact to the registration payment at the Registry Operator level and at ICANN org?

d6) To ensure that the “same entity” principle is followed, the transfer of a domain name registration to a new entity -- voluntary or involuntary, and inter-registrants or inter-registrars -- should result in transfer of all variant domain names (i.e., if s1.t1 is to be transferred, s1.t1, s1.t1v1, s1v1.t1 and s1v1.t1v should all be transferred).

The WG, the Transfer Policy PDP, and the RPM PDP Phase 2 to coordinate and consider the following questions in order to develop a consistent solution: to what extent should the Transfer Policy be updated to reflect domain name relationships due to variants and the “same entity” requirement?

d6a) Should transfers ordered by the Uniform Domain-Name Dispute-Resolution Policy (UDRP) or any other dispute resolution mechanisms be treated the same way to follow the “same entity” requirement?²²⁴

d7) Should the policies and procedures related to domain name suspension be updated to ensure that the “same entity” principle is followed for all variant domain names (i.e., if s1.t1 is to be suspended, s1.t1v1, s1v1.t1 and s1v1.t1v1 should all be suspended)? In other words, if one domain label is suspended, either voluntarily or involuntarily, should all the variant labels related to that domain be suspended?

d7a) Should the suspensions ordered by the Uniform Rapid Suspension System (URS) or any other dispute resolution mechanisms be treated the same way to follow the “same entity” requirement?²²⁵

d8) What additional updates to the Registry Agreement are necessary to ensure the labels under variant TLDs follow the “same entity” rule? For example, the Staff Paper recommends that the following requirements must be included in the Registry Agreement; some of the charter questions are also related to those topics:²²⁶

- Subordinate names allocated by the Registry Operator in the TLD be treated as an atomic set. This is true irrespective of whether any of the names is actually activated in the DNS, and whether any of the variants is actually registered. **[related to questions c1, d4, d5]**

- All the different IDN tables being used by the IDN gTLD and its variant gTLDs be harmonized. **[related to questions c4, c5]**
- All the IDN variant TLDs be implemented through the same registry service provider, to promote a consistent and stable implementation across all such variant TLDs. **[related to questions b2, b4]**

Are there any additional updates that need to be considered that are not included in this list?

E. Adjustments to objection process, string similarity review, string contention resolution, reserved strings, and other policies and procedures:

This Charter recognizes the processes established by the SubPro PDP and the inclusion of questions here is not to amend the structure or framework of those processes but rather, to ensure that they are able to properly accommodate variants and follow the same entity principle for existing and future gTLDs.

e1) In considering the conclusion(s) with respect to question **b4a)**, what role, if any, do TLD labels “withheld for possible allocation” or “withheld for the same entity” play vis-a-vis:

- objection process; and
- string similarity review process?

e2) Under the rules of the most recent gTLD application round, there are four criteria for objections to a string (see *gTLD Applicant Guidebook*, version 2012-06-04, section 3.2.1).²²⁷ The SubPro PDP has also affirmed the continuation of these four criteria for objections to a string, while proposing recommendations and implementation guidance to enhance/adjust these criteria.²²⁸

The WG and the SubPro IRT to coordinate to ensure consistency in the implementation of the **objection** process for the variant label applications of existing and future TLDs.

e3) In the Initial Evaluation for new gTLD applications, a proposed applied-for TLD is checked against several criteria as part of the string similarity review process (see *gTLD Applicant Guidebook*, version 2012-06-04, section 2.2.1.1.1).²²⁹ The SubPro PDP affirmed these standards, while proposing recommendations and implementation guidance to enhance the process.²³⁰

²²⁴ See more details about the UDRP related discussions in Section 3.7 in the Staff Paper, pp.17-18:

<https://www.icann.org/en/system/files/files/idn-variant-tld-recommendations-analysis-25jan19-en.pdf#page=17>

²²⁵ See more details about the URS related discussions in Section 3.7 in the Staff Paper, p.18:

<https://www.icann.org/en/system/files/files/idn-variant-tld-recommendations-analysis-25jan19-en.pdf#page=18>

²²⁶ Section 3.6 in the Staff Paper, p.16: <https://www.icann.org/en/system/files/files/idn-variant-tld-recommendations-analysis-25jan19-en.pdf#page=16>:

²²⁷ The four criteria are: String Confusion Objection; Legal Rights Objection; Limited Public Interest Objection; and Community Objection.

²²⁸ See “Topic 31: Objections” in the SubPro PDP Final Report, pp.145-154:

<https://gnso.icann.org/sites/default/files/file/field-file-attach/final-report-newgtld-subsequent-procedures-pdp-02feb21-en.pdf#page=145>

²²⁹ These criteria are: existing TLDs and reserved names; other applied-for strings; strings requested as IDN ccTLDs; and applied-for 2-character IDN gTLD strings against every other single character and any other 2-character ASCII string.

²³⁰ See “Topic 24: String Similarity Evaluations” in the SubPro PDP Final Report, pp.108-114:

<https://gnso.icann.org/sites/default/files/file/field-file-attach/final-report-newgtld-subsequent-procedures-pdp-02feb21-en.pdf#page=108>

The WG and the SubPro IRT to coordinate to ensure consistency in the implementation of the **string similarity review** procedure for variant label applications of existing and future gTLDs.²³¹

e3a) After a requested variant string is rejected as a result of a string similarity review, should the other variant strings in the same variant set remain allocatable? Should individual labels be allowed to have different outcomes/actions (e.g., some labels be blocked and some be allowed to continue with an application process)?²³²

e4) Under current procedures, resolution of string contention for applied for gTLD strings may include components such as a settlement between the parties, a community priority evaluation (if a community-based applicant in a contention set elects this option), and an auction. SubPro PDP affirmed these components while proposing recommendations and implementation guidance to enhance the mechanisms for string contention resolution.²³³

The WG and the SubPro IRT to coordinate to ensure consistency in the implementation of the **string contention resolution** mechanism for variant label applications of existing and future new gTLDs.²³⁴

²³¹ The Staff Paper recommends that the string similarity process to compare strings under consideration not just against all allocated or applied-for strings, but also all variants of those strings (including allocatable, withheld-same-entity, and blocked). For example, if a string is merely withheld-same-entity and a second string is visually similar, then allocating the second string undermines the predictability of the outcome of variant processing from the RZ-LGR. Similarly, if a string is blocked under the RZ-LGR, but a visually similar string is allocatable, then the second (visually similar) string might become a “work around” for the blocked string. This approach is maximally conservative. It is nevertheless worth noting that this expands considerably the number of strings that might need to be considered; the entire similarity review process will consequently probably become more expensive to operate. See Section 3.8 Adjustments in String Similarity Process in the Staff Paper, pp.18-19: <https://www.icann.org/en/system/files/files/idn-variant-tld-recommendations-analysis-25jan19-en.pdf#page=18>

Staff Paper further recommends that in the event that two or more applied-for variant strings are visually similar, they may only be allocated if they are associated with the same variant set and are being requested by the same entity. In case of such conflicts across variants, the entire IDL set gets processed as one contention set; if one of the labels is already allocated, the contention is resolved in favor of the current operator. The Staff Paper recommends that it is necessary to perform the visual similarity checks for every requested-to-be-allocated variant in any given set against all the possible variants in every other set. This is because such an available variant could be requested at any time in the future. See Section 3.8.1 in the Staff Paper, pp.20-21: <https://www.icann.org/en/system/files/files/idn-variant-tld-recommendations-analysis-25jan19-en.pdf#page=20>

²³² The Staff Paper recommends that the following outcomes may be considered: 1) only the variant string requested for delegation is rejected. For example, the requested variant t1v2 of top-level label t1 will get rejected while t1v1 and t1v3 from the same variant set continue to remain allocatable; or 2) the entire variant set is rejected. For example, the requested variant t1v2 of top-level label t1 will get rejected including t1v1 and t1v3 from the same variant set as t1v2. This outcome appears to be difficult to justify, though an applicant could decide that, if it cannot receive t1v2 then it does not wish to proceed with the application. See Section 3.8.2 in the Staff Paper, pp.21:

<https://www.icann.org/en/system/files/files/idn-variant-tld-recommendations-analysis-25jan19-en.pdf#page=21>
²³³ See “Topic 35” in the SubPro PDP Final Report, pp. 173-182: <https://gns0.icann.org/sites/default/files/file/field-file-attach/final-report-newgtd-subsequent-procedures-pdp-02feb21-en.pdf#page=173>

²³⁴ For contention issues that involve the same entity, the Staff Paper suggests that the following resolution options may be considered, with a preference to the second option: 1) When the requested variant strings are placed in a contention set for later evaluation, the applicant is notified of the contention set and has the opportunity to establish that both applications are from the same entity. 2) It may be more efficient to establish early on in the string similarity review that the variant strings are being requested by the same entity prior to reaching the contention phase. See Section 3.8.2 in the Staff Paper, p. 21: <https://www.icann.org/en/system/files/files/idn-variant-tld-recommendations-analysis-25jan19-en.pdf#page=21>

e5) The WG and the SubPro IRT to coordinate and consider the following questions in order to develop a consistent solution: should the **reserved strings** ineligible for delegation for existing and future gTLDs be updated to include any possible variant labels? Consider this question by taking into account the data to be collected in the “Data and Metric Requirements” section of this charter.

e6) The WG and the SubPro IRT to coordinate and consider the following questions in order to develop a consistent solution: is there any reason to permit the registration of gTLDs consisting of decorated two-character Latin labels which are not variant labels of any two-letter ASCII labels?²³⁵ If so, rationale must be clearly stated.

e7) Besides the objection process, string similarity review, and string contention resolution, what other ICANN policies and procedures should be updated to enforce the “same entity” rule and the use of RZ-LGR as the sole source to calculate the variant Labels and disposition values?²³⁶ See the list of ICANN Consensus Policies here: <https://www.icann.org/resources/pages/registrars/consensus-policies-en>

F. Adjustments in registration dispute resolution procedures and trademark protection mechanisms:

f1) Trademark Clearinghouse (TMCH) mechanism functions include authenticating information from rights holders and providing this information to registries and registrars. Recording a trademark with the TMCH provides a rights holder with access to Sunrise registration periods in new gTLD registries and the Trademark Claims services. If Registry Operator has implemented IDN variant registration policies for the TLD, Registry Operator MAY allocate or register IDN variant labels generated from a label included in a valid SMD file during the Sunrise Period, provided that (i) such IDN variant registration policies are based on the Registry Operator’s published IDN tables for the TLD and (ii) such policies are imposed consistently in the Sunrise Period, any Limited Registration Period, any Launch Program and during General Registration.²³⁷

The Review of All Rights Protection Mechanisms (RPMs) in All gTLDs PDP Phase 1 recommends maintaining the TMCH’s current “exact match” rules, the current availability of Sunrise registrations only for identical matches, and the current exact matching criteria for the Claims Notice.²³⁸

²³⁵ The ccTLD labels in the root depend on an external registry (ISO 3166) that allocates alphabetic codes to countries. In order to ensure that no conflicts with future assignments by ISO can happen, ICANN has traditionally also maintained a restriction against the use of two-letter TLDs for all Latin script letters; no variants should be generated for ccTLDs based on the ISO3166 codes. This principle is also reaffirmed by the SubPro PDP. See Recommendation 21.6 in the SubPro Final Report, p.95: <https://gnso.icann.org/sites/default/files/file/field-file-attach/final-report-newgtld-subsequent-procedures-pdp-02feb21-en.pdf#page=95>

²³⁶ IDN Variant TLD Implementation Staff Paper: <https://www.icann.org/en/system/files/files/idn-variant-tld-recommendations-analysis-25jul18-en.pdf>

²³⁷ See section 2.4.2 of the Trademark Clearinghouse Rights Protection Mechanism Requirements: <http://newgtlds.icann.org/en/about/trademark-clearinghouse/rpm-requirements-30sep13-en.pdf>

²³⁸ See RPM Phase 1 Final Report, TMCH Final Recommendation #2, Sunrise Final Recommendation #4, and Trademark Claims Final Recommendation #4 on pp.35-36, 44, and 52-53 here: <https://gnso.icann.org/sites/default/files/file/field-file-attach/rpm-phase-1-proposed-24nov20-en.pdf>

In considering the information above, are there any adjustments to the TMCH and its Sunrise and Trademark Claims services needed?²³⁹ Consider this question by taking into account the data to be collected in the “Data and Metric Requirements” section of this charter.

f2) In order to ensure that the “same entity” principle is maintained, what are the additional operational and legal impacts to the following RPMs that are not considered in the above charter questions, which mostly concern the outcomes or remedies of dispute resolution procedures or trademark protection mechanisms?

- TMCH and its Sunrise and Trademark Claims services
- URS
- TM-PDDRP
- UDRP

IDN Implementation Guideline

G. Process to update the IDN Implementation Guidelines

g1) What should be the proper vehicle to update the IDN Implementation Guidelines?²⁴⁰

g1a) Given that the contracted parties are contractually bound to adhere to the IDN Implementation Guidelines, is there a need for a separate legal mechanism specifically for the implementation of IDNs among gTLDs, as well as a general guideline for any registry (including ccTLD registries) that wishes to implement IDNs?

Deliverables:

The WG shall respect the timelines and deliverables as outlined in [Annex A](#) and Annex A-1 of the ICANN Bylaws, the [EPDP Manual](#), and the [PDP Manual](#).

For the avoidance of doubt, the following sections of the PDP Manual shall not apply to an EPDP:

- Section 2 (Requesting an Issue Report);
- Section 4 (Recommended Format of Issue Report Requests);
- Section 5 (Creation of the Preliminary Issue Report);

²³⁹ SAC060 points out that in the current design of RPMs related to the TMCH process, there is a risk of homographic attacks. From a security and operations perspective, domain names that contain variants of a mark must be protected during the Sunrise and Claims Period. SSAC advises two ways to handle variants and TMCH to achieve such protections; each has benefits and downsides: 1) variant calculation at the registry level, and checking TMCH for the existence of marks for variants in the calculated variant set; 2) variant calculation and checking inside the TMCH in addition to the already defined matching algorithm TMCH uses. See more information in SAC060, recommendation 10 on pp.16-18: <https://www.icann.org/en/system/files/files/sac-060-en.pdf#page=16> SAC060 further argues that the “exact match” as defined by TMCH is not really an identical match as in “bit-by-bit” or “character-by-character comparison” as a transformation stage is included before the actual matching. From a technical standpoint, the transformation stage currently as specified from is unclear and does not take non-ASCII based scripts into account. See SAC060, Recommendation 12, pp.19-20: <https://www.icann.org/en/system/files/files/sac-060-en.pdf#page=19>. The SSAC also advises that during the Trademark Claims service, a name registered under a TLD that has variant TLDs should trigger trademark holder notifications for the registration of the name in the TLD and all its allocated variant TLDs. See SAC060, Recommendation 13, p.20: <https://www.icann.org/en/system/files/files/sac-060-en.pdf#page=20>

²⁴⁰ ccPDP4 refers to the Country Code Names Supporting Organization’s Policy Development Process on the Selection and Deselection of IDN ccTLD Strings. The process to update the RDAP Profiles is being developed by the Contracted Parties and ICANN org as part of their ongoing contractual negotiations. A DT member suggested that once that is finalized, the EPDP Working Group may want to consider that as a model for updating the IDN Guidelines.

- Section 6 (Public Comment on the Preliminary Issue Report); and
- Section 7 (Initiation of the PDP)

Except as otherwise expressly modified or excluded herein, all other provisions of the PDP Manual shall apply in full to an EPDP, including without limitation the publication of an Initial Report for public comments. In the event of a conflict in relation to an EPDP between the provisions of the PDP Manual and the specific provisions in the EPDP Manual, the provisions herein shall prevail.

As its first deliverable, the WG is expected to deliver to the GNSO Council a **work plan**, in addition to other project management products that help plan, guide, track, and report the progress of the WG from start to finish, and include the necessary data and information to help the GNSO Council assess the progress of the WG. See more details in Section III. of this charter.

At the minimum, the WG shall complete the following deliverables:

- An **Initial Report** which includes preliminary recommendations that stem from the charter questions as noted in the “Mission and Scope” section of this Charter, as well as other items that were considered and deliberated upon by the WG.
- A **Final Report** following review of public comment for the Initial Report.

The WG has the discretion to produce additional outputs or deliverables for public comment opportunities as it deems appropriate.

Furthermore, the WG should identify a **set of metrics** to measure the effectiveness of the policy recommendations. The identification, attainment, and analysis of metrics/data should be based on how they address the challenge of achieving security and usability goals for IDN variants in a stable manner. Current state baselines of the policy and initial benchmarks shall also be identified. Metrics may include but not limited to:

- ICANN Compliance data;
- Industry metric sources;
- Community input via public comment;
- Surveys or studies.

If the WG concludes with **any recommendations**, the WG should also provide a high-level framework or **implementation guidance** to the subsequent policy Implementation Review Team for their consideration when implementing the recommendations after the ICANN Board adoption.

Data and Metric Requirements:

The WG may consider collecting the following suggested data and metrics as a starting point to assist its deliberations. However, the WG has the discretion to determine what specific data and metrics it wishes to collect to meet the purposes below.

1. Determine a set of questions which, when answered, provide the insight necessary to achieve the policy goals.

See all the questions under “scope & charter questions” of Section II: Mission, Purpose, and Deliverables

2. Determine whether certain data is required to help understand a specific issue or answer a charter question (charter question numbers are indicated next to the data points).

- Using the latest version of the RZ-LGR determine the variant labels of the 2012 New gTLD Round and determine whether the list of calculated variants match those that were identified by the applicant (a2)
- Time needed to create an LGR script proposal and frequency a RZ-LGR is updated (a4, a6)
- Methods used to establish the same entity at the second-level by the same Registrar and across different Registrars (c3, c3a)²⁴¹
- Number of registries that use the machine readable LGR format specified in RFC 7940 for second-level IDN tables (c6)
- Using the latest version of the RZ-LGR determine the variant labels, if any, of i) all delegated gTLDs, and ii) all ICANN reserved TLD labels. Determine whether the calculation is consistent with reality or whether any exceptions need to be considered (e5)
- Breakdown of the scripts/languages represented in a validated and active trademark in the TMCH (f1)

3. Determine a set of data and metrics which can be collected and analyzed to help answer the specific question.

See data points under item 2 above.

4. Submit a Working Group Metrics Request Form (see GNSO Working Group Guidelines Section 4.5), if data gathering at the charter drafting phase or during the working phase is deemed necessary.

At the charter drafting phase, no metrics request is deemed necessary. WG leaders shall review the [Checklist: Criteria to Evaluate Request for Data Gathering](#) to understand the need for performing due diligence before submitting a data gathering request to the GNSO Council.

Section III: Project Management

Work Product Requirement:

The WG leadership, in collaboration with the WG support staff and GNSO Council liaison, shall use a standard set of project management work products that help plan, guide, track, and report the progress of the WG from start to finish, and include the necessary data and information to assess the progress of the WG. These work products include but not limited to:

- Work Plan
- Summary Timeline
- Project Situation Report
- Project Plan
- Action Items

See the full suite of work products in the [GNSO Project Work Product Catalog](#).

²⁴¹ At the charter drafting phase, no extensive survey requiring budget allocation or potential third party involvement was envisioned to collect the suggested data point. The GNSO Council Charter Drafting Team envisioned that a questionnaire may be developed by the WG and distributed to the contracted parties via ICANN org. Nevertheless, the WG has the discretion to determine what specific data and metrics it wishes to collect and what methods to collect them.

Specifically, the WG is expected to deliver its work plan to the GNSO Council as its first deliverable. The work plan is expected to include a proposed sequence to address the topics covered in this charter, as well as a map of dependencies among these topics.

The WG may choose to conduct its work in one, two, or multiple phase(s) based on the sequence of topics that it identifies. Consequently, the WG has the discretion to produce additional outputs or deliverables for public comment opportunities as it deems appropriate.

The WG's last Final Report is expected to be delivered to the GNSO Council for its consideration no later than 12 months after the WG convenes for its first meeting.

Project Status & Condition Assessment:

The WG leadership, in collaboration with the WG support staff and the GNSO Council liaison, shall assess the Status and Condition of the project at least once a month. Such frequency is required in preparation for the GNSO Council monthly meeting, where At-Risk or In-Trouble projects are subject to review by GNSO Council leadership, and in some instances may be deliberated by the full GNSO Council.

The WG leadership, in collaboration with the WG support staff and the GNSO Council Liaison, shall use an [escalation procedure](#), which defines specific conditions that trigger the execution of a repeatable mitigation plan. The objective of this exercise is to return the project to an acceptable state ultimately achieving its planned outcomes.

Project Change Request:

The WG shall submit a [Project Change Request \(PCR\) Form](#) to the GNSO Council when its deliverable and baseline delivery date are revised. The PCR shall include a rationale for why these changes were made, their impacts on the overall timeframe of the PDP or any other interdependencies, and a proposed remediation plan.

The use of the PCR mostly occurs when primary deliverable dates are changed due to unforeseen or extreme circumstances. However, it can also be used to document changes in the deliverable requirements that may not have been identified in the chartering process.

When the PCR is required, it should be completed by the WG Chair and it will likely be presented to the GNSO Council for approval.

Resources Tracking:

The purpose for resource tracking is to deliver its work according to the work plan and be responsible for managing these resources.

For projects where dedicated funds are provided outside of budgeted policy activities, the WG shall provide regular budget versus actual expense reporting updates using a GNSO approved tool to allow for a better tracking of the use of resources and budget.

Section IV: Formation, Staffing, and Organization

Working Group Model:

Working Group Model: Representative + Open Model (Members + Participants + Observers)

Rationale: The “Representative + Open Model” is chosen to enable the WG to conduct and conclude its work in an efficient/effective manner while satisfying the outreach purpose to have an inclusive community participation.

A limited number of ICANN community members have prerequisite knowledge, background, or expertise in the subject matter. As a result, a limited number of Members appointed by specified community groups, who must possess a level of expertise as detailed in the “Membership Criteria” section in this charter, should drive the deliberations of the WG and participate in the consensus designation process for final recommendations.

Nevertheless, as the IDN topic is of interest to the broader ICANN community and impacts various stakeholders, the WG welcomes anyone to join as a Participant, who can attend and actively participate in all WG meetings, with the exception of the consensus designation process. Participants are encouraged to possess similar levels of expertise as Members and continuously engage in the WG deliberation throughout its lifecycle in order to effectively participate and contribute input.

Membership Structure:

Role Descriptions: All persons actively participating in the Working Group (i.e., Members and Participants) are expected to abide by the Statement of Participation, which is enforceable by the WG Chair and GNSO Council Leadership Team. See Section V. for details.

- **Members:** Members are expected to participate during the course of deliberations and in any WG consensus calls. Members are expected to represent the view of their appointing organization, and may be called on to provide the official position of their appointing organization. Members are required to have a level of expertise in IDN issues, ICANN policies and procedures as they relate to IDNs, and registry/registrar services and domain name life cycle. See “Membership Criteria” section of this charter for more details.

In the event a GNSO SG/C or SO/AC is unable to nominate a member, at least one Participant should be responsible for keeping their respective group informed of milestones and potential recommendations that may affect the group

- **Participants:** Participants may be from a GNSO SG/C or SO/AC, or may be self-appointed and derive from within the ICANN or broader community. Participants will be able to actively participate in and attend all WG meetings. Participants are encouraged to participate in the WG deliberation throughout its lifecycle and are expected to keep up with all relevant WG deliberations to ensure they remain informed and can contribute when needed. However, Participants do not participate in the consensus designation process.

Participants are encouraged to possess similar levels of expertise as Members with respect to IDN issues, ICANN policies and procedures, and registry/registrar services in order to contribute to the deliberations effectively.

No upper limit of participants are expected to be set at the chartering phase. However, the WG leadership may decide, in consultation with the WG, whether new Participants can be accepted after the start of the WG effort. See details in the “B. Joining of New Members After Project Launch” in this charter.

- **Observers:** Anyone interested in this EPDP may join as an observer. Observers are provided with read-only access to the mailing list and are not invited to attend meetings.
- **GNSO Council Liaison:** The GNSO Council shall appoint one (1) Liaison who is accountable to the GNSO. The GNSO Council Liaison must be a member of the Council, and the Council recommends that the Liaison should be a Council member and be able to serve during the life of this WG. See detailed description in the “GNSO Council Liaison” section below.
- **ccNSO Liaison:** The Country Code Names Supporting Organization (ccNSO) shall appoint one (1) Liaison to monitor the deliberation of this WG. This is to fulfill ICANN Board’s request that the GNSO coordinates with the ccNSO to ensure a consistent solution is developed for IDN variant TLDs and IDN variant ccTLDs. ccNSO has the option to appoint its Liaison also as its Member who represents the ccNSO in this EPDP WG. Any person from the ccNSO may participate as a Participant in the WG.
- **ICANN Org Liaison(s):** The ICANN Org Global Domains & Strategy (GDS) department shall appoint at least one (1) Liaison, who is expected to provide timely input on issues that may require ICANN Org input such as implementation-related queries and issues requiring subject matter expertise in IDNs. The ICANN Staff Liaison(s) is not expected to advocate for any position and/or participate in any EPDP Team consensus calls.

Membership Structure:

Some groups may choose not to appoint any Members to the WG. The table below indicates the maximum number of Members that groups may appoint.

Group	Member (up to)	Liaison
RySG	3	
RrSG	3	
IPC	3	
BC	3	
ISPCP	3	
NCSG	3	

ccNSO	3	1*
ALAC	3	
GAC	3	
SSAC	3	
RSSAC	3	
GNSO Council		1
ICANN Org GDS		At least 1

**ccNSO has the option to appoint its liaison also as one of its Member(s) who represent the ccNSO in this EPDP WG.*

The GNSO Secretariat is expected to circulate a “Call For Volunteers” in accordance with the group structure determined by the GNSO Council:

- Publication of announcement on relevant ICANN web sites including but not limited to the GNSO and other Supporting Organizations and Advisory Committee web pages; and
- Distribution of the announcement to GNSO Stakeholder Groups, Constituencies and other ICANN Supporting Organizations and Advisory Committees

Membership Criteria:

A. Expected Skills for Working Group Members

WG members shall review the full text of the [Working Group Member Skills Guide](#) to understand the responsibilities and skills that they are expected to have in order to fully participate in the WG activities.

Collectively as a group, the WG Members MUST possess:

- Technical knowledge of IDNs, including but not limited to: IDN related SubPro PDP recommendations, RZ-LGR, IDN variant definition and management, IDN tables, IDN implementation guidelines, SSAC advices as they relate to IDNs, and other policy efforts listed in the [Annex B](#) of the GNSO Council IDN Scoping Team Final Report; direct experiences in ICANN’s IDN policy efforts is strongly preferred;
- Technical, legal, and/or operational knowledge of ICANN policies and procedures as they relate to IDNs, including but not limited to: processes and procedures created for the 2012 New gTLD program, registration dispute resolution procedures and trademark protection mechanisms;
- Technical knowledge of registry/registrar services and domain name life cycle as they relate to IDNs;
- Familiarity with GNSO policy development processes; direct experience is strongly preferred;
- Commitment to participating in Working Group meetings on a regular and ongoing basis;
- Highly effective oral, written, and interpersonal communication skills (in simple, comprehensible English);
- Ability to create factual, relevant and easily understandable messages, and able to succinctly deliver them to the Working Group;
- Research skills with the ability to discern factual, factually relevant, and persuasive details and sources;

- Commitment to manage a diverse workload, while collaborating with a Working Group of individuals with different backgrounds and interests in driving objectives;
- Knowledge of Working Group discussions, actions taken at meetings, and deliverables;
- Understanding of the perspectives and interests of the members' own stakeholder group or constituency;
- Understanding of what consensus means and how consensus-building process works;
- Commitment to facilitate consensus by listening, explaining, mediating, proposing clear actions, and helping other members;
- Commitment to avoid blocking consensus by looking beyond the stakeholder group or constituency affiliation of other Working Group members and judging proposals/positions on their merits;
- Commitment to avoid re-litigating closed issues or deliberate obfuscation;
- Commitment to review the [Consensus Playbook](#) and attend potential training related to the Playbook, facilitate consensus building by employing the tools and techniques as detailed in the playbook;
- Maintain high personal levels of ethical conduct and integrity, including transparency of affiliation in the SOI, in treatment of others and respecting the professional reputation of all in the ICANN community.

Participants are encouraged to possess the aforementioned qualifications.

B. Joining of New Members After Project Launch

New Members will only join after the launch of the PDP if a current Member is no longer able to continue in its membership. New WG Members should be mindful that, once input/comment periods have been closed, discussions or decisions should not be resurrected unless there is group consensus that the issue should be revisited in light of new information that has been introduced. If the reopening is perceived as abusive or dilatory, a WG member may appeal to the WG leadership.

Anyone can join a WG as a Participant at any point as long as they get up to speed and do not reopen previously closed topics, unless they provide new information. Nonetheless, the WG leadership may decide, in consultation with the WG and in reference of [Criteria for Joining of New Members](#) guidance, whether new Participants can be accepted after the start of the WG effort.

The WG could decide to suspend new Participants for several reasons, including but not limited to:

- The Working Group has produced its Initial Report, analyzed public comments, and is in the midst of a consensus process for its Final Report;
- The Working Group is nearing the end of a complex and lengthy policy development process and although it has not produced a Final Report, the status of the work is that the Working Group is too close to finalize its work such that new members would not be able to meaningfully contribute;
- Someone wishes to join as a participant in a sub-team of the Working Group, but that sub-team has completed its work and passed its recommendations to the full Working Group.

C. Expert Contributors

The WG has flexibility/discretion to invite participation of the expert contributors in specific fields (e.g., rights protection mechanism related topics) as it deems necessary.

Expert contributors are not expected to participate in any consensus designation process, but provide perspective/expertise/knowledge to the PDP WG.

Based on the WG's determination, the Council may be able to use an independent evaluation process (e.g., GNSO Council Standing Selection Committee) to confirm whether those individuals have demonstrated the expertise/knowledge/perspective.

Leadership Structure:

One (1) Chair + One (1) Vice Chair

The GNSO Council will appoint one (1) qualified, independent Chair (neutral, not counted as from the WG membership/participants) for the WG.

The WG, once formed, may select one (1) Vice Chair to assist the Chair. The Vice Chair can be selected among the WG's Members and Participants. However, if a Member is selected as the Vice Chair, this person shall change his/her Member status to Participant, and his/her appointing organization may appoint a new Member as a replacement.

Should at any point a Vice Chair need to step into the role of Chair, the same expectations with regards to fulfilling the role of Chair as outlined in this charter will apply.

Leadership Criteria:

Expectations for the WG Leadership (Chair + Vice Chair):

The WG leadership is expected to carry out the role and responsibilities and meet the qualification as detailed in the [Expectations for Working Group Leaders & Skills Checklist](#).

In short, the WG leadership is expected to:

- Lead with neutrality and impartiality;
- Encourage representational balance;
- Ensure WG documents represent the diversity of views;
- Balance working group openness with effectiveness;
- Make time commitment;
- Contribute ideas and knowledge to working group discussions;
- Oversee project management of the WG deliberations;
- Build consensus;
- Make consensus designation on working group recommendations;
- Enforce compliance with Statement of Participation;
- Enforce compliance with ICANN's Expected Standards of Behavior;
- Ensure compliance with Community Anti-Harassment Policy;
- Be versed in GNSO Operating Procedures; and
- Handle working group complaint process.

Expectation for the WG Chair:

As outlined in the GNSO Working Group Guidelines, the purpose of a Chair is to call meetings, preside over working group deliberations, manage the process so that all participants have the opportunity to contribute, and report the results of the Working Group to the Chartering Organization. These tasks require a dedicated time commitment as each week calls have to be prepared, the agenda concretized, and relevant material reviewed. The Chair shall be neutral. While the Chair may be a member of any group which also has

representation on the Working Group, the Chair shall not act in a manner which favors such group. The Chair shall not be a member of the Working Group for purposes of consensus calls.

In addition, it is expected – that interested candidates shall have considerable experience in chairing working groups, and direct experience with at least one GNSO Policy Development Process throughout its lifecycle. Familiarity with the functioning of a Working Group is important to understand the various leadership skills that are necessary to employ during a WG’s lifecycle. For example, a Chair has to ensure that debates are conducted in an open and transparent manner and that all interests are equally and adequately represented within the Group’s discussions. During the later stages of a WG when recommendations are drafted, a Chair will benefit from understanding the viewpoints of various participants to ensure that an acceptable and effective outcome – ideally in the form of consensus – can be achieved.

The WG Chair is specifically expected to carry out the following responsibilities, including but not limited to:

- Attend all EPDP Working Group meetings to assure continuity and familiarity with the subject matter and the ongoing discussions;
- Prepare meetings by reading all circulated materials;
- Be familiar with the subject matter and actively encourage participation during the calls;
- Be active on the EPDP mailing list and invite EPDP WG members and liaisons to share their viewpoints;
- Drive the progress forward and assure that discussions remain on point;
- Work actively towards achieving policy recommendations that ideally receive full consensus;
- Ensure that particular outreach efforts are made when community reviews are done of the group's output;
- Underscore the importance of achieving overall representational balance on any sub-teams that are formed;
- Enforce Statement of Participation, ICANN’s Standards of Behavior, and Community Anti-Harassment Policy;
- Coordinate with staff and ensure that the WG is supported as effectively as possible; and
- Conduct consistent, adequate, and timely reporting to the GNSO Council on the progress of the PDP.

The WG Chair is expected to meet most of the following qualifications:

- Direct experience in consensus building processes and preferably direct experience in GNSO PDPs;
- Knowledge of and preferably direct experience in IDN related work at ICANN;
- Knowledge of ICANN policies and procedures as they relate to IDNs;
- Understanding of registry/registrar services and domain name life cycle as they relate to IDNs;
- Project management skills: including facilitating goal-oriented Working Group meetings, agenda setting and adherence, time management, encouraging collaboration, driving the completion of action items and achieving milestones in accordance with the WG timeline and work plan, keeping the Working Group’s actions, discussions and meetings focused on serving its ultimate goals and deliverables;
- Ability to enforce compliance with the Statement of Participation, ICANN’s Expected Standards of Behavior, and Community Anti-harassment Policy;
- Ability to determine when outreach is necessary and to undertake it;
- Ability to identify the diversity of views within the Working Group, if applicable;
- Knowledge of and ability to designate consensus on Working Group recommendations based on the level of agreement;
- Ability to help Working Group members understand that a consensus is a decision that is collaboratively reached and that the Working Group members can “live with”; accordingly, it may not be a perfect or unanimous decision;

- Commitment to review the [Consensus Playbook](#) and attend potential training related to the Playbook, facilitate consensus building by employing the tools and techniques as detailed in the playbook;
- Ability to refrain from promoting a specific agenda and ensuring fair, objective treatment of all opinions within the Working Group;
- Ability to distinguish between Working Group participants offering genuine dissent and those raising irrelevant or already closed issues merely to block the Working Group's progress toward its goal;
- Ability to halt disruption and, in extreme cases, exclude a Working Group member from a discussion per Section 3.5 of the GNSO Working Group Guidelines on Rules of Engagement;
- Ability to ensure that closed Working Group decisions are not revisited, unless there is a consensus to do so (usually in light of new information brought to the Working Group's attention);
- Ability to commit the time required to perform the WG Chair's responsibilities;
- Knowledge of topics in other policy efforts that have relations to or dependencies with the EPDP working group topics;
- Ability to create factual, relevant and easily understandable messages, and able to clearly deliver them to the Working Group
- Ability to deliver a point clearly, concisely, and in a friendly way
- Exhibit agility and confidence in evolving situations and is able to swiftly transition from topic to topic
- Highly effective oral, written, and interpersonal communication skills (in simple, comprehensible English);
- Excellent research skills with the ability to discern factual, factually relevant, and persuasive details and sources;
- Commitment to manage a diverse workload, while collaborating with a Working Group of individuals with different background and interests in driving objectives; and
- Able to effectively build a course of action, analyze trade-offs, and make recommendations even in ambiguous situations; and
- Knowledge of and ability to participate in the Working Group complaint process, commitment to review the [Clarification to Complaint Process in GNSO Working Group](#) Guidelines Section 3.7.

Expressions of Interest for the WG Chair:

Staff is expected to publish a request for Expressions of Interest for the role of Chair. The GNSO Council leadership and Standing Selection Committee leadership will jointly review the responses and will propose a Chair to the GNSO Council which will then either affirm the selection or reject the selection and send the process back to the GNSO Council leadership and Standing Selection Committee leadership.

The Expression of Interest should address the following issues, including but not limited to:

- What is the applicant's interest in this position?
- What particular skills and attributes does the applicant have that will assist him/her in chairing the WG and facilitating consensus building?
- What is the applicant's knowledge of and/or experience in IDN related work at ICANN?
- What is the applicant's knowledge of ICANN policies and procedures?
- What is the applicant's understanding of registry/registrar services and domain name life cycle as they relate to IDNs?
- What is the applicant's experience with the GNSO Policy Development Process?
- What is the applicant's experience with consensus building involving various stakeholders, as well as familiarity with the [Consensus Playbook](#)?
- Is the applicant able to commit the time required and necessary work needed to chair the EPDP?
- Does the applicant have any affiliation with or involvement in any organization or entity with any financial or non-financial interest in the subject matter of this EPDP?

- Also expected to be included:
 - A link to an up-to-date Statement of Interest (SOI) - <https://community.icann.org/x/c4Lg>
 - A statement confirming commitment and ability to act neutrally.

Expectations for the Vice Chair:

Finally, as also pointed out in the GNSO Working Group Guidelines, the Vice Chair may facilitate the work of the Chair by ensuring continuity in case of absence, sharing of workload, and allowing the Chair to become engaged in a particular debate. As a result, similar responsibilities and qualifications are expected from the Vice Chair, although the overall workload may be reduced as a result of being able to share this with the Chair.

Leadership Review:

The review of WG leadership provides a regular opportunity for the GNSO Council to check in with WG leadership and Council Liaison to identify resources or input that Council may need to provide, as well as opportunities for the leadership team to improve. The review also enables the GNSO Council to work with the WG leadership and Council Liaison to develop and execute a plan to address possible issues/opportunities identified.

The GNSO Council leadership and/or the Council Liaison may initiate the WG leadership review in response to circumstances indicating that a review is necessary.

The WG leadership shall review the full text of [Regular Review of Working Group Leadership](#) document to understand the regular review of WG leadership performance by the GNSO Council, as well as the [member survey](#) that feeds into the review. This leadership review may be conducted alongside the [WG self-assessment](#), or be integrated as part of the WG self-assessment based on the GNSO Council's further improvement of the review mechanism.

GNSO Council Liaison

The GNSO Council shall appoint one (1) Liaison who is accountable to the GNSO. The Liaison must be a member of the Council, and the Council recommends that the Liaison should be a Council member and be able to serve during the life of this WG.

The complete description of role & responsibilities for GNSO Council Liaison is described in the [GNSO Council Liaison Supplemental Guidance](#). In short, the GNSO Council Liaison is expected to:

- Fulfill liaison role in a neutral manner
 - Importantly, the liaison is expected to fulfil his/her role in a neutral manner. This means that everything the liaison does during his/her tenure, including but not limited to participating in WG calls, reporting status, conveying information, and escalating issues, should be done in that neutral manner.
- Serve as an interim WG Chair until a Chair is named
- Be a regular participant of WG meetings
- Participate in regular meetings with WG Chair
- Report to Council on the WG progress
- Convey to Council on WG communications, questions, concerns
- Inform WG Chair about Council activities impacting the WG
- Refer to Council questions related to WG Charter

- Assist or engage when WG faces challenges
- Assist in case of abuse of ICANN’s Expected Standards of Behavior and Community Anti-Harassment Policy
- Assist with knowledge of WG processes and practices
- Facilitate when there is disagreement regarding consensus designation
- Facilitate when a Section 3.7 Complaint Process is invoked
- Initiate the WG leadership review in response to circumstances indicating that a review is necessary

The liaison shall complete the following actions for onboarding purposes:

- Review the [GNSO Council liaison to the WGs - Role Description](#);
- Review the [New Liaison Briefing and Liaison Handover](#) document to understand the actions the liaison needs to take for onboarding purposes.
- Consult the [supplemental guidance](#) developed to provide more precision in their responsibilities and the frequency in which they must be carried out;
- Familiarize with the provisions of the GNSO Operating Procedures relevant to liaisons;
- Subscribe to the EPDP mailing lists and relevant sub teams;
- Subscribe to the EPDP Leadership mailing list(s), if applicable. In addition, add o the PDP Leadership Skype chat (or other communication channel) if applicable;
- Consider requesting a catch up call with the relevant GNSO policy support staff. This call should clarify the role of the liaison in terms of PDP conference call attendance, expected responsibilities and an update as to the current status of the PDP if already in operation (milestones and anticipated hurdles);
- Review links to the wiki workspaces and mailing list archives via email;
- (If the EPDP is already in operation) Consider requesting that EPDP Leadership and the outgoing liaison(s) share relevant briefing documents specific to the EPDP, to highlight the scope of the PDP charter, current status, timeline, milestones, problem areas/challenges, anticipated hurdles, etc;
- (If the EPDP is already operational) Participate in an onboarding conference call with the incoming and outgoing liaisons as well as EPDP Leadership; GNSO policy support staff will also be present on the call.

Support Staff:

The ICANN Staff assigned to the WG will fully support the work of the Working Group as requested by the Chair including meeting support, document drafting, editing and distribution and other substantive contributions when deemed appropriate.

Staff assignments to the Working Group:

- ICANN policy staff members
- GNSO Secretariat

In addition, regular participation of and consultation with other ICANN Org departments such as the GDS is anticipated to ensure timely input on issues that may require ICANN org input such as implementation-related queries and issues requiring subject matter expertise in IDNs. As such, the ICANN Org GDS is expected to appoint at least one (1) Liaison to the WG, as specified in the “Membership Structure” section above.

Furthermore, additional policy staff resources are available to assist the WG leadership for consensus building purposes.

Section V: Rules of Engagement

Statements of Interest (SOI) Guidelines:

Each member of the WG is required to submit an SOI in accordance with Section 5 of the GNSO Operating Procedures.

Statement of Participation:

Each Member and Participant of the WG must acknowledge and accept the Statement of Participation (as provided below), including ICANN's Expected Standards of Behavior, before he/she can participate in the WG.

Statement of Participation

As a Member or Participant of the Internationalized Domain Names Expedited Policy Development Process Working Group:

- I agree to genuinely cooperate with fellow Members and Participants of the Working Group to deliberate the issues outlined in the Charter. Where there are areas of disagreement, I will commit to work with others to reach a compromise position to the extent that I am able to do so;
- I acknowledge the remit of the GNSO to develop consensus policies for generic top level domains. As such, I will abide by the recommended working methods and rules of engagement as outlined in the Charter, particularly as it relates to rules in [GNSO Working Group Guidelines](#);
- I will treat all Members/Participants of the Working Group with civility both face-to-face and online, and I will be respectful of their time and commitment to this effort. I will act in a reasonable, objective, and informed manner during my participation in this Working Group and will not disrupt the work of the Working Group in bad faith;
- I will make best efforts to regularly attend all scheduled meetings and send apologies in advance when I am unable to attend. I will take assignments allocated to me during the course of the Working Group seriously and complete these within the requested timeframe.
- I agree to act in accordance with [ICANN Expected Standards of Behavior](#), particularly as they relate to:
 - Acting in accordance with, and in the spirit of, ICANN's mission and core values as provided in [ICANN's Bylaws](#);
 - Listening to the views of all stakeholders and working to build consensus; and
 - Promoting ethical and responsible behavior;
- I agree to adhere to any applicable conflict of interest policies and the Statement of Interest (SOI) Policy within the [GNSO Operating Procedures](#), especially as it relates to the completeness, accuracy, and timeliness of the initial completion and maintenance of my SOI; and
- I agree to adhere to the [ICANN Community Anti-Harassment Policy and Terms of Participation and Complaint Procedures](#).

As a Member of the IDN EPDP Working Group:

- I understand reaching consensus does not mean that I am unable to fully represent the views of myself or the organization I represent. I will abide by the recommended working methods and rules of engagement as outlined in the Charter, particularly as it relates to designating consensus in [GNSO Working Group Guidelines](#).

I acknowledge and accept that this Statement of Participation, including ICANN’s Expected Standards of Behavior, is enforceable and any individual serving in a Chair role (such as Chair, Co-Chair, or Acting Chair or Acting Co-Chair) of the Working Group and GNSO Council Leadership Team have the authority to restrict my participation in the Working Group in the event of non-compliance with any of the above.

Problem/Issue Escalation & Resolution Process:

The problem/issue escalation & resolution process within the WG is provided in Sections 3.4 and 3.5 of the Working Group Guidelines. WG members should also reference the [Guidelines Concerning ICANN Org Resources for Conflict Resolution and Mediation](#).

Formal Complaint Process:

The formal complaint process within the WG is provided in Section 3.7 of the Working Group Guidelines. Further details regarding the formal complaint process are included in the [Clarification to Complaint Process in GNSO Working Group Guidelines](#) document.

The formal complaint process may be modified by the GNSO Council at its discretion.

Section VI: Decision Making Methodologies**Consensus Designation Process:**

Section 3.6 of the GNSO Working Group Guidelines, as included below, provides the standard consensus-based methodology for decision making in GNSO WGs.

For consensus building purposes, the WG Leadership, WG Members, and GNSO Council Liaison are expected to review the [Consensus Playbook](#) which provides practical tools and best practices to bridge differences, break deadlocks, and find common ground within ICANN processes; potential training related to the Consensus Playbook may be provided for WG Leadership, Members, and GNSO Council Liaison.

3.6 Standard Methodology for Making Decisions

The Chair will be responsible for designating each position as having one of the following designations:

- **Full consensus** - when no one in the group speaks against the recommendation in its last readings. This is also sometimes referred to as **Unanimous Consensus**.
- **Consensus** - a position where only a small minority disagrees, but most agree. *[Note: For those that are unfamiliar with ICANN usage, you may associate the definition of 'Consensus' with other definitions and terms of art such as rough consensus or near consensus. It should be noted, however, that in the case of a GNSO PDP originated Working Group, all reports, especially Final Reports, must restrict themselves to the term 'Consensus' as this may have legal implications.]*
- **Strong support but significant opposition** - a position where, while most of the group supports a recommendation, there are a significant number of those who do not support it.
- **Divergence** (also referred to as **No Consensus**) - a position where there isn't strong support for any particular position, but many different points of view. Sometimes this is due to irreconcilable differences of opinion and sometimes it is due to the fact that no one has a particularly strong or convincing viewpoint, but the members of the group agree that it is worth listing the issue in the report nonetheless.
- **Minority View** - refers to a proposal where a small number of people support the recommendation. This can happen in response to a **Consensus**, **Strong support but significant opposition**, and **No Consensus**; or, it can happen in cases where there is neither support nor opposition to a suggestion made by a small number of individuals.

In cases of **Consensus**, **Strong support but significant opposition**, and **No Consensus**, an effort should be made to document that variance in viewpoint and to present any **Minority View** recommendations that may have been made. Documentation of **Minority View** recommendations normally depends on text offered by the proponent(s). In all cases of **Divergence**, the WG Chair should encourage the submission of minority viewpoint(s).

The recommended method for discovering the consensus level designation on recommendations should work as follows:

- i. After the group has discussed an issue long enough for all issues to have been raised, understood and discussed, the Chair, or Co-Chairs, make an evaluation of the designation and publish it for the group to review.
- ii. After the group has discussed the Chair's estimation of designation, the Chair, or Co-Chairs, should reevaluate and publish an updated evaluation.
- iii. Steps (i) and (ii) should continue until the Chair/Co-Chairs make an evaluation that is accepted by the group.

- iv. In rare case, a Chair may decide that the use of polls is reasonable. Some of the reasons for this might be:
- A decision needs to be made within a time frame that does not allow for the natural process of iteration and settling on a designation to occur.
 - It becomes obvious after several iterations that it is impossible to arrive at a designation. This will happen most often when trying to discriminate between **Consensus** and **Strong support but Significant Opposition** or between **Strong support but Significant Opposition** and **Divergence**.

Care should be taken in using polls that they do not become votes. A liability with the use of polls is that, in situations where there is **Divergence** or **Strong Opposition**, there are often disagreements about the meanings of the poll questions or of the poll results.

Based upon the WG's needs, the Chair may direct that WG participants do not have to have their name explicitly associated with any Full Consensus or Consensus view/position. However, in all other cases and in those cases where a group member represents the minority viewpoint, their name must be explicitly linked, especially in those cases where polls were taken.

Consensus calls should always involve the entire Working Group and, for this reason, should take place on the designated mailing list to ensure that all Working Group members have the opportunity to fully participate in the consensus process. It is the role of the Chair to designate which level of consensus is reached and announce this designation to the Working Group. Member(s) of the Working Group should be able to challenge the designation of the Chair as part of the Working Group discussion. However, if disagreement persists, members of the WG may use the process set forth below to challenge the designation.

If several participants²⁴² in a WG disagree with the designation given to a position by the Chair or any other consensus call, they may follow these steps sequentially:

1. Send email to the Chair, copying the WG explaining why the decision is believed to be in error.
2. If the Chair still disagrees with the complainants, the Chair will forward the appeal to the CO liaison(s). The Chair must explain his or her reasoning in the response to the complainants and in the submission to the liaison. If the liaison(s) supports the Chair's position, the liaison(s) will provide their response to the complainants. The liaison(s) must explain their reasoning in the response. If the CO liaison disagrees with the Chair, the liaison will forward the appeal to the CO. Should the complainants disagree with the liaison support of the Chair's determination, the complainants may appeal to the Chair of the CO or their designated representative. If the CO agrees with the complainants' position, the CO should recommend remedial action to the Chair.
3. In the event of any appeal, the CO will attach a statement of the appeal to the WG and/or Board report. This statement should include all of the documentation from all steps in the appeals process and should include a statement from the CO²⁴³.

²⁴² Any Working Group member may raise an issue for reconsideration; however, a formal appeal will require that a single member demonstrates a sufficient amount of support before a formal appeal process can be invoked. In those cases where a single Working Group member is seeking reconsideration, the member will advise the Chair and/or liaison of their issue and the Chair and/or liaison will work with the dissenting member to investigate the issue and to determine if there is sufficient support for the reconsideration to initial a formal appeal process.

²⁴³ It should be noted that ICANN also has other conflict resolution mechanisms available that could be considered in case any of the parties are dissatisfied with the outcome of this process.

Who Can Participate in Consensus Designation:

Consensus calls or decisions are limited to Members who may consult as appropriate with their respective appointing organizations. However, for the purpose of assessing consensus, groups that do not fulfil their maximum membership allowance should not be disadvantaged.

The WG Chair shall ensure that all perspectives are appropriately taken into account in assessing Consensus designations on the final recommendations.

Unless otherwise specified in this Charter, the GNSO Working Group Guidelines apply in full and Consensus designations are therefore the responsibility of the Work Group Chair and are to be made in accordance with the consensus levels described in Section 3.6 of the Working Group Guidelines.

Termination or Closure of Working Group:

Typically, the WG will close upon the delivery of its last Final Report, unless assigned additional tasks or follow-up by the GNSO Council.

The GNSO Council may terminate or suspend the WG prior to the publication of its last Final Report for significant cause such as changing or lack of community volunteers, the planned outcome for the project can no longer be realized, or when it is clear that no consensus can be achieved.

The WG Chair, in collaboration with the WG support staff and the GNSO Council Liaison, shall use an [escalation procedure](#), which helps define the health of the WG and informs the GNSO Council’s decision on whether the WG should be terminated or suspended.

Section VII: Change History

Section VIII: Charter Document History

Version	Date	Description
1.0	10 May 2021	

Staff Contact:	Ariel Liang	Email:	Policy-Staff@icann.org
-----------------------	-------------	---------------	--

Translations: If translations will be provided please indicate the languages below:

--	--	--	--	--	--	--	--	--	--	--	--	--

9 Annex C – Consensus Designations

Below is the EPDP-IDNs Leadership Team’s designation as to the level of consensus on each recommendation in this Phase 1 Final Report. These designations were made following the process as outlined in the message to the EPDP Team mailing list on 12 October 2023 and in accordance with Section 3.6 - Standard Methodology for Making Decisions of the GNSO Working Group Guidelines.²⁴⁴ By the deadline of 21 October 2023, no objection was received from EPDP members to the Leadership Team’s proposed Consensus Designations.²⁴⁵

Recommendation #	Leadership Team’s Proposed Designation
Section 4.1 RZ-LGR as the Sole Source	
Final Recommendation 1.1	Full Consensus
Section 4.2 Same Entity Principle	
Final Recommendation 2.1	Full Consensus
Section 4.3 Application Submission, Administrative Check, Initial Evaluation	
Final Recommendation 3.1	Full Consensus
Final Recommendation 3.2	Full Consensus
Final Recommendation 3.3	Full Consensus
Final Recommendation 3.4	Full Consensus
Final Recommendation 3.25	Full Consensus
Final Recommendation 3.5	Full Consensus
Implementation Guidance 3.6	Full Consensus
Final Recommendation 3.7	Full Consensus
Implementation Guidance 3.8	Full Consensus
Implementation Guidance 3.9	Full Consensus
Final Recommendation 3.10	Full Consensus

²⁴⁴ See the message sent by Support Staff on behalf of the EPDP leadership team here: <https://mm.icann.org/pipermail/gnso-epdp-idn-team/2023-October/001151.html>; see the GNSO Working Group Guidelines here: <https://gnso.icann.org/sites/default/files/file/field-file-attach/annex-1-gnso-wg-guidelines-24oct19-en.pdf>

²⁴⁵ <https://mm.icann.org/pipermail/gnso-epdp-idn-team/2023-October/001160.html>

Final Recommendation 3.11	Full Consensus
Final Recommendation 3.12	Full Consensus
Final Recommendation 3.13	Full Consensus
Final Recommendation 3.14	Full Consensus
Final Recommendation 3.15	Full Consensus
Final Recommendation 3.16	Full Consensus
Final Recommendation 3.17	Full Consensus
Final Recommendation 3.18	Full Consensus
Final Recommendation 3.19	Full Consensus
Final Recommendation 3.20	Full Consensus
Final Recommendation 3.21	Full Consensus
Final Recommendation 3.22	Full Consensus
Implementation Guidance 3.23	Full Consensus
Final Recommendation 3.24	Full Consensus
Section 4.4 String Similarity Review	
Final Recommendation 4.1	Full Consensus
Final Recommendation 4.2	Full Consensus
Final Recommendation 4.3	Full Consensus
Final Recommendation 4.4	Full Consensus
Section 4.5 Objection Processes	
Final Recommendation 5.1	Full Consensus
Final Recommendation 5.2	Full Consensus
Final Recommendation 5.3	Full Consensus
Final Recommendation 5.4	Full Consensus
Final Recommendation 5.5	Full Consensus
Section 4.6 String Contention	

Final Recommendation 6.1	Full Consensus
Final Recommendation 6.2	Full Consensus
Section 4.7 Contractual Requirements	
Final Recommendation 7.1	Full Consensus
Implementation Guidance 7.2	Full Consensus
Final Recommendation 7.3	Full Consensus
Final Recommendation 7.4	Full Consensus
Final Recommendation 7.5	Full Consensus
Final Recommendation 7.6	Full Consensus
Final Recommendation 7.7	Full Consensus
Final Recommendation 7.8	Full Consensus
Final Recommendation 7.9	Full Consensus
Final Recommendation 7.10	Full Consensus
Final Recommendation 7.11	Full Consensus
Final Recommendation 7.12	Full Consensus
Implementation Guidance 7.13	Full Consensus
Final Recommendation 7.14	Full Consensus
Section 4.8 Delegation and Removal	
Final Recommendation 8.1	Full Consensus
Final Recommendation 8.2	Full Consensus
Implementation Guidance 8.3	Full Consensus
Final Recommendation 8.4	Full Consensus
Final Recommendation 8.5	Full Consensus
Final Recommendation 8.6	Full Consensus
Final Recommendation 8.7	Full Consensus
Final Recommendation 8.8	Full Consensus

Implementation Guidance 8.9	Full Consensus
Final Recommendation 8.10	Full Consensus
Final Recommendation 8.11	Full Consensus
Implementation Guidance 8.12	Full Consensus
Final Recommendation 8.13	Full Consensus
Section 4.9 Variant Label States	
Final Recommendation 9.1	Full Consensus
Implementation Guidance 9.2	Full Consensus
Final Recommendation 9.3	Full Consensus
Implementation Guidance 9.4	Full Consensus

10 Annex D – Responses to Phase 1 Charter Questions

This annex documents the brief responses agreed by the EPDP Team to all of the Phase 1 charter questions. The Phase 1 recommendations were derived from these responses. After the publication of its Phase 1 Initial Report for Public Comment, the EPDP Team did not revisit these responses but focused on finalizing its recommendations by considering the input received. Therefore, the text below is the same as that included in Annex C of the Phase 1 Initial Report.²⁴⁶

#	Charter Question	EPDP Team Agreed to the Following:
A1	Evaluating all TLDs using RZ-LGR as the one and only authoritative source allows for a consistent approach for reviewing current and future TLDs. The SubPro PDP, the Staff Paper, and the Study Group on Technical Use of RZ-LGR (“TSG”) recommend that compliance with RZ-LGR (RZ-LGR-4, and any future RZ-LGR versions) must be required for the validation of all future gTLDs (including IDN and ASCII labels) and the calculation of their variant labels as a matter of policy, including the determination of whether the disposition of the label should be blocked or allocatable. ²⁴⁷ For existing delegated gTLD labels, does the WG recommend using the RZ-LGR as the sole source to calculate the variant labels and disposition values?	The RZ-LGR must be the sole source to calculate the variant labels and disposition values for existing delegated gTLDs from the 2012 round.
A2	Before the proposed RZ-LGR mechanism, applications for IDN gTLDs have asked the applicant to identify and list any variant labels (based on their own calculations) corresponding to the applied-for string.	No recommendation or implementation guidance is needed for the self-identified gTLD “variant” labels in the 2012 round, as they do not have legal standing and are for information purposes only. It does not

²⁴⁶ See Annex C of the Phase 1 Initial Report here: <https://itp.cdn.icann.org/en/files/internationalized-domain-names-idn/phase-1-initial-report-internationalized-domain-names-expedited-policy-development-process-24-04-2023-en.pdf#page=144>

²⁴⁷ See Recommendation 25.2 and Implementation Guidance 26.10 in the SubPro Final Report, pp.115, 119: <https://gnso.icann.org/sites/default/files/file/field-file-attach/final-report-newgtld-subsequent-procedures-pdp-02feb21-en.pdf#page=115>; Recommendation 1 in the Staff Paper, p.3: <https://www.icann.org/en/system/files/files/idn-variant-tld-recommendations-analysis-25jan19-en.pdf#page=3>; Recommendation 1 in the TSG report, p.5: <https://www.icann.org/en/system/files/files/rz-lgr-technical-utilization-recs-07oct19-en.pdf#page=5>

#	Charter Question	EPDP Team Agreed to the Following:
	<p>The self-identified “variant” labels do not have legal standing, as “[d]eclaring variant strings is informative only and will not imply any right or claim to the declared variant strings.”²⁴⁸ The TSG recommends that the self-identified “variant” labels which are also variant labels calculated by RZ-LGR will need to be assigned a variant disposition based on RZ-LGR calculation, as discussed in A1. If some self-identified “variant” TLD labels by the former gTLD applicants are not found consistent with the calculation of the RZ-LGR, but have been used to certain extent (e.g., used to determine string contention sets), how should such labels be addressed in order to conform to the LGR Procedure and RZ-LGR calculations? Consider this question by taking into account the data to be collected in the “Data and Metric Requirements” section of this charter.</p>	<p>matter whether any of the self-identified “variant” labels were used for any purpose in the 2012 round (if at all).</p>
A3	<p>SubPro PDP recommends that ICANN establish a mechanism that allows specific parties to challenge or appeal certain types of actions or inactions that appear to be inconsistent with the Applicant Guidebook.²⁴⁹ SubPro PDP recommends that such a limited challenge/appeal mechanism applies to several types of evaluations and formal objections decisions, including the DNS Stability aspect of evaluation/challenge procedures. Previously, both the SSAC and TSG also recommended a challenge process for resolving disagreement with the RZ-LGR calculation on certain</p>	<ul style="list-style-type: none"> • An application for a gTLD string in a script supported by the RZ-LGR that is deemed by the RZ-LGR (as implemented in the algorithmic check component of the new gTLD application submission system) as "invalid" or "blocked" (i.e. as the calculated disposition value where the applied-for string is a variant label) may be submitted but will be marked ‘subject to disqualification’ pending a DNS Stability Review. When the "invalid" or "blocked" result is confirmed by the DNS Stability Review, the application will be disqualified and cannot proceed further in the application process.

²⁴⁸ For more details see *gTLD Applicant Guidebook*, version 2012-06-04, section 1.3.3 IDN Variant TLDs, p.1-35:

<https://newgtlds.icann.org/en/applicants/agb/guidebook-full-04jun12-en.pdf>

²⁴⁹ See Recommendation 32.1 in the SubPro Final Report, pp.154-155:

<https://gnso.icann.org/sites/default/files/file/field-file-attach/final-report-newgtld-subsequent-procedures-pdp-02feb21-en.pdf#page=154>

#	Charter Question	EPDP Team Agreed to the Following:
	<p>strings.²⁵⁰ If an applied-for TLD label, whose script is supported by the RZ-LGR, is determined to be “invalid”, is there a reason NOT to use the evaluation challenge processes recommended by SubPro? If so, rationale must be clearly stated. If SubPro’s recommendation on the evaluation challenge process should be used, what are the criteria for filing such a challenge? Should any additional specific implementation guidance be provided, especially pertaining to the challenge to the LGR calculation as it can have a profound, decimating impact on the use of RZ-LGR?²⁵¹</p>	<ul style="list-style-type: none"> ● However, if the applicant believes that its applied-for string has been deemed "invalid" or "blocked" due to an incorrect technical implementation of the RZ-LGR, that application may proceed subject to the outcomes of the limited challenge mechanism recommended by SubPro, wherein: <ul style="list-style-type: none"> ○ An applicant can challenge a DNS Stability Review evaluation determination by the DNS Stability Panel (DSP) that the applied-for gTLD string is “invalid” or “blocked”. ○ Eligibility for filing such a challenge is limited to the applicant’s belief that the DSP has incorrectly assessed the label as “invalid” or “blocked”. ○ The evaluation challenge processes and criteria applicable to the DNS Stability Review recommended in the SubPro PDP Final Report must be used for such a challenge.
A4	<p>For future gTLD applications, the SubPro PDP proposes an implementation guidance that if a script is not yet integrated into the RZ-LGR, applicants should be able to apply for a string in that script, and it should be</p>	<p>This charter question is moot as all scripts of all existing delegated gTLDs from the 2012 round are already integrated into the RZ-LGR version 5, which was published on</p>

²⁵⁰ Disagreement with the LGR calculator may arise due to circumstances including but not limited to: an invalid label due to choice of "letter" not included in the repertoire, albeit being IDNA2008 protocol-valid; an invalid label due to a contextual or whole label evaluation rule imposed by either integration or generation panels’ variant; labels differ because of different assumptions. SAC060 proposed a straw man process to resolve disputes to the RZ-LGR results. The TSG recommended several technical inputs be considered when developing the resolution mechanism. See Recommendation 2, SAC060, p.9: <https://www.icann.org/en/system/files/files/sac-060-en.pdf#page=9>; see Recommendation 4 in the TSG Report, pp.6-7: <https://www.icann.org/en/system/files/files/rz-lgr-technical-utilization-recs-07oct19-en.pdf#page=6>

²⁵¹ Any changes in RZ-LGR brought about by a process outside the LGR Procedure would invalidate the RZ-LGR and thus the definition of the TLD variant TLD labels, as stated in the LGR Procedure. TSG suggests how to address such a challenge by remaining within the LGR Procedure.

#	Charter Question	EPDP Team Agreed to the Following:
	<p>processed up to but not including contracting.²⁵² Applicants under such circumstances should be warned of the possibility that the applied-for string may never be delegated and they will be responsible for any additional evaluation costs. The burden in this case is on the applicant, who may have to wait for an indeterminate amount of time but is not aware of any other serious concerns. The SubPro PDP developed this implementation guidance by taking into consideration the TSG recommendation that the application should remain on-hold (or other appropriate status) until the relevant script is integrated into the RZ-LGR.²⁵³ The WG and the SubPro IRT to coordinate and consider the following questions in order to develop a consistent solution: should the SubPro recommendation be extended to existing TLDs that apply for a variant TLD label whose script is not yet supported by the applicable version of the RZ-LGR? Consider this question in tandem with B4 and by taking into account the data to be collected in the “Data and Metric Requirements” section of this charter. If not, what should be the process for an existing TLD registry who wishes to apply for a variant TLD label whose script is not yet supported by the applicable version of the RZ-LGR?</p>	<p>26 May 2022.²⁵⁴ Hence no recommendation or implementation guidance is needed.</p>

²⁵² See Implementation Guidance 25.3 in the SubPro Final Report, p.115:

<https://gnso.icann.org/sites/default/files/file/field-file-attach/final-report-newgtld-subsequent-procedures-pdp-02feb21-en.pdf#page=115>

²⁵³ It is important to recognize that the RZ-LGR can be updated to include additional scripts as long as it is done in compliance with the LGR Procedure. The practical limitation, however, is that the time to create an LGR script proposal varies greatly (i.e. months or years). See Recommendation 5 in the TSG report, p.7:

<https://www.icann.org/en/system/files/files/rz-lgr-technical-utilization-recs-07oct19-en.pdf#page=7>; for additional context and rationale, see Appendix A of the Recommendations for Technical Utilization of RZ-LGR, pp.11-12:

<https://www.icann.org/en/system/files/files/rz-lgr-technical-utilization-recs-07oct19-en.pdf#page=11>

²⁵⁴ Learn more about the RZ-LGR version 5 here: <https://www.icann.org/en/announcements/details/icann-publishes-root-zone-label-generation-rules-version-5-rz-lgr-5-26-05-2022-en>

#	Charter Question	EPDP Team Agreed to the Following:
A5	<p>SAC060 notes that variant code points in LGR may introduce a “permutation issue”, possibly creating a large number of variant domain names, which “presents challenges for the management of variant domains at the registry, the registrar and registrant levels.”²⁵⁵ SAC060 advises that “ICANN should ensure that the number of strings that are activated is as small as possible.” The TSG agreed with this SSAC advice.²⁵⁶ Appendix C of the Staff Paper reviewed the factors causing numerous variant labels and suggested measures to address this issue.²⁵⁷</p> <p>Should there be a ceiling value or other mechanism to ensure that the number of delegated top-level variant labels remains small, understanding that variant labels in the second level may compound the situation? Should additional security and stability guidelines be developed to make variant domains manageable at the registry, registrar, and registrant levels?²⁵⁸</p>	<ul style="list-style-type: none"> ● Only a limited number of scripts are impacted by the potential overproduction of allocatable variant labels. ● There will not be ceiling values beyond the existing measures imposed by the RZ-LGR to reduce the number of allocatable top-level variant labels. ● However, guidelines on managing IDN gTLDs and their variant labels should be developed for registries and registrars as a way to provide a positive and predictable registrant experience. A framework for developing guidelines for the management of IDN gTLDs and their variant labels at the top-level must be created during implementation.
A6	<p>Since RZ-LGR can be updated over time, the WG needs to consider the implications for existing TLD labels and their variant labels (if any), including any potential changing of status or disposition value.²⁵⁹ The TSG further recommends that the Generation Panel (GP) must call out the</p>	<ul style="list-style-type: none"> ● Based on data presented by staff, all existing delegated gTLDs from the 2012 round are valid according to the current version of RZ-LGR.²⁶¹ ● It is extremely unlikely that a proposed RZ-LGR update would invalidate a

²⁵⁵ See Recommendation 14, SAC060, p. 20: <https://www.icann.org/en/system/files/files/sac-060-en.pdf#page=20>

²⁵⁶ See Recommendation 6 in the TSG report, p.7: <https://www.icann.org/en/system/files/files/rz-lgr-technical-utilization-recs-07oct19-en.pdf#page=7>

²⁵⁷ See Appendix C of the IDN Variant TLD Implementation: Appendices, pp. 12-29: <https://www.icann.org/en/system/files/files/idn-variant-tld-appendices-25jan19-en.pdf#page=12>

²⁵⁸ One of the security and stability concerns is that some scripts can generate large numbers of variant labels based on the way the LGR works. The RZ-LGR Procedure manages such numbers by minimizing allocatable variant labels and maximizing blocked variant labels. However, though this approach is optimal in most cases, the outcome may be worse for a specific label in some cases.

²⁵⁹ See Recommendation 7 in the TSG report, p.8: <https://www.icann.org/en/system/files/files/rz-lgr-technical-utilization-recs-07oct19-en.pdf#page=8>

²⁶¹ This data was collected by GDS Staff to determine the complete set of variant labels of all existing gTLDs from the 2012 New gTLD Program. The data was presented by staff during the EPDP Team meeting on 18 November 2021: <https://community.icann.org/x/hwO7Cg>

#	Charter Question	EPDP Team Agreed to the Following:
	<p>exception where an existing TLD is not validated by their proposed solution during the public comment period and explain the analysis and reasons for not supporting the existing TLD in their script LGR proposal.²⁶⁰ This will allow the community and the GP to review such a case to confirm that an exception is indeed warranted. Does the WG agree with TSG’s suggested approach? If so, to what extent should the TLD policies and procedures be updated to allow an existing TLD and its variants (if any), which are not validated by a script LGR, to be grandfathered? If not, what is the recommended approach to address changes to the current version of the RZ-LGR that assign different disposition values to existing TLDs? Consider this question by taking into account the data to be collected in the “Data and Metric Requirements” section of this charter.</p>	<p>delegated gTLD and its delegated and allocated variant labels (if any), as all updates of the RZ-LGR are expected to retain full backward compatibility.²⁶²</p> <ul style="list-style-type: none"> ● In the unexpected event where a proposed RZ-LGR update is unable to retain full backward compatibility, the TSG recommendation proposed in the Charter question must be applied. ● All delegated gTLDs and their delegated and allocated variant labels (if any) not validated by a proposed RZ-LGR update must be grandfathered.

²⁶⁰ See Recommendation 12 in the TSG report, p.9: <https://www.icann.org/en/system/files/files/rz-lgr-technical-utilization-recs-07oct19-en.pdf#page=9>

²⁶² There are stability clauses or mechanisms in the RZ-LGR, IDNA2008, and the Unicode base layer to ensure that existing gTLDs will be allowed to remain despite future changes.

- Unicode has a comprehensive set of stability policies: <https://www.unicode.org/versions/Unicode14.0.0/ch03.pdf> and <https://www.unicode.org/policies>. The key stability policies are that characters do not get moved/removed, and the stability of the Normalization Forms.
- IDNA 2008 relies on its use of Unicode stable function like normalization to assure stability and use the General Category property (GC) to ensure its own stability. RFC 5892 contains stability considerations in its introduction: <https://datatracker.ietf.org/doc/html/rfc5892>. Because GC is not part of the immutable set in Unicode, there is a mechanism in IDNA 2008 to allow backward compatibility to maintain stability: “Changes in Unicode properties that do not affect the outcome of this process do not affect IDN. For example, a character can have its Unicode General_Category value (see Unicode52: <https://datatracker.ietf.org/doc/html/rfc5892#ref-Unicode52>) change from So to Sm or from Lo to Ll, without affecting the algorithm results. Moreover, even if such changes were the result, the BackwardCompatible list (Section 2.7: <https://datatracker.ietf.org/doc/html/rfc5892#section-2.7>) can be adjusted to ensure the stability of the results.”
- RZ-LGR relies on the Stability principle (pg. 12) of the LGR Procedure: “Once a code point is permitted, it is almost impossible to stop permitting it: the act of permitting a code point cannot be undone. This is particularly true once a label containing this code point has been registered.” <https://www.icann.org/en/system/files/files/lgr-procedure-20mar13-en.pdf> This is repertoire stability policy concerning the RZ-LGR. This does not guarantee 100% stability, to allow fixes in case of errors for example. Any change proposed by the Generation Panel must be reviewed and approved by the Integration Panel, which holds a conservative approach and only approves changes if they pass an extremely high bar.

#	Charter Question	EPDP Team Agreed to the Following:
A7	<p>The SubPro PDP recommends that single character gTLDs may be allowed for limited script/language combinations where a character is an ideograph (or ideogram) and do not introduce confusion risks that rise above commonplace similarities, consistent with SAC052 and Joint ccNSO-GNSO IDN Workgroup (JIG) report.²⁶³ What mechanism or criteria should be used to identify the scripts/languages appropriate for single-character TLDs? Once those scripts/languages are identified, what mechanism or criteria should be used to identify a specific list of allowable characters which can be used as a single-character TLD within such scripts/languages? Should any specific implementation guidance be provided? Furthermore, should the relevant GP tag these code points in the RZ-LGR for a consistent analysis and to ease their identification and algorithmic calculation?²⁶⁴</p>	<ul style="list-style-type: none"> ● The EPDP Team affirms the SubPro’s recommendation that single-character gTLDs may be allowed for ideographic scripts and languages. ● At the time of the EPDP Team’s discussion, the Han script is the only ideographic script included in the RZ-LGR, and Chinese, Japanese, and Korean are the only languages incorporating the Han script. Therefore, the Chinese language, the Kanji portion of the Japanese language, and the Hanja portion of the Korean language, which all use the Han script, are appropriate for single-character gTLDs.²⁶⁵ ● The EPDP Team requested the Chinese, Japanese, and Korean Generation Panels to develop guidelines for a prohibitive list of Han characters that must not be allowed as single-character TLDs. The Generation Panels may conduct this work based on their existing process and

²⁶³ See Recommendation 25.4 in the SubPro PDP Final Report, p.115: <https://gns0.icann.org/sites/default/files/file/field-file-attach/final-report-newgtld-subsequent-procedures-pdp-02feb21-en.pdf#page=115>; Recommendation 1 in SAC052, p.8: <https://www.icann.org/en/system/files/files/sac-052-en.pdf#page=8>; the SubPro PDP does not believe it has the relevant expertise to make this determination and would welcome the identification of the limited set of scripts and languages and potentially a specific list of allowable single-characters (e.g., during implementation), which will substantially increase the predictability of what will likely still remain a case-by-case, manual process. See Rationale for Recommendation 25.4 in the SubPro PDP Final Report, pp.116-117: <https://gns0.icann.org/sites/default/files/file/field-file-attach/final-report-newgtld-subsequent-procedures-pdp-02feb21-en.pdf#page=116>

²⁶⁴ See Annex B of the Recommendations for the Technical Utilization of the RZ-LGR, p.13: <https://www.icann.org/en/system/files/files/rz-lgr-technical-utilization-recs-07oct19-en.pdf#page=13>

²⁶⁵ Concerning the term ideogram (and related ideograph), Unicode uses it to refer to the Chinese, Japanese and Korean (CJK) repertoire: <https://www.unicode.org/versions/Unicode14.0.0/ch18.pdf> (page 728): “The term ‘Han ideographic characters’ is used within the Unicode Standard as a common term traditionally used in Western texts, although ‘sinogram’ is preferred by professional linguists. Taken literally, the word ‘ideograph’ applies only to some of the ancient original character forms, which indeed arose as ideographic depictions. The vast majority of Han characters were developed later via composition, borrowing, and other non-ideographic principles, but the term ‘Han ideographs’ remains in English usage as a conventional cover term for the script as a whole.” Using this terminology, the Han script is the only ideographic script included in the RZ-LGR; see <https://www.icann.org/sites/default/files/lgr/lgr-4-overview-05nov20-en.pdf>, Section 7.2 (the table describes the repertoire per script).

#	Charter Question	EPDP Team Agreed to the Following:
		<p>procedures, and the output should be subject to Public Comment for broader community input.</p> <ul style="list-style-type: none"> Applications for single-character gTLDs will not be accepted until relevant guidelines from the Chinese, Japanese, and Korean Generation Panels are implemented in the New gTLD Program.
A8	<p>What additional aspects of gTLD policies and procedures, which are not considered in the above charter questions, need to be updated to ensure that the validation of existing TLD labels and calculation of variant labels depend exclusively on the RZ-LGR in a consistent manner?</p>	<p>An EPDP Team member suggested that the group consider what contextual information should be included in the registration data for variant labels of delegated primary gTLDs, both in the IANA WHOIS and Registry WHOIS. The EPDP Team plans to address this question in Phase 2 of its deliberation, specifically under charter question D8, as this issue is more related to second-level domain name registrations.</p>
A9	<p>A given label in an Internationalized Domain Label (IDL) set may be in one of the following non-exhaustive status: delegated, withheld-same-entity, blocked, allocated, rejected. The WG and the SubPro IRT to coordinate and develop a consistent definition of variant label status in the IDL set.</p>	<ul style="list-style-type: none"> Accept the five label states for variant labels proposed in the Staff Paper as a preliminary recommendation. Definition of label states for variant labels must be consistent with the definition of equivalent application states used for the New gTLD Program. Label states should be made publicly accessible and tracked by ICANN org as long as the primary gTLD remains delegated.
A10	<p>Individual labels in an IDL set may go through the following possible status transformations:</p> <ul style="list-style-type: none"> from “withheld-same-entity” to “allocated”: Allocation only to the same entity as another label in the IDL set. This change happens if a 	<ul style="list-style-type: none"> Accept the label state transitions proposed in the Staff Paper as a preliminary recommendation. Clarify that the label state transition from “rejected” to “withheld-same-entity” is not automatic, but only

#	Charter Question	EPDP Team Agreed to the Following:
	<p>variant was not initially requested for allocation and later is. Allocating withheld labels would be the application process for a variant TLD.</p> <ul style="list-style-type: none"> ● from “blocked” to “withheld-same-entity”: A later LGR may broaden the available labels in the IDL set. Such possible labels automatically become withheld-same-entity. ● from “allocated” to “delegated”: Happens when name servers are added. (Not new.) ● from “delegated” to “allocated”: If a domain is removed from the DNS, the allocation can remain in place anyway. Rare in the root zone, but not new. ● from “rejected” to “withheld-same-entity”: Every Rejected label is automatically Withheld-same-entity as well. If the Rejected status comes off, the label can be handled as any other Withheld-same-entity label. <p>Note that an allocated or withheld-same-entity label cannot become blocked unless a new version of the LGR makes this possible. The WG and the SubPro IRT to coordinate and consider the following questions in order to develop a consistent solution: what is the procedure to change the label status for individual variant labels?</p>	<p>happens when the ground for the rejected state is removed.</p>
B1	<p>Both the SubPro PDP and the Staff Paper recommend that variant TLDs that ICANN delegates must have the “same entity” as the sponsoring organization and the “Registry Operator” be used as the definition of the “same entity” at the top-</p>	<p>The SubPro PDP and Staff Paper recommendations must be extended to existing IDN gTLDs.</p>

#	Charter Question	EPDP Team Agreed to the Following:
	level. ²⁶⁶ Should this recommendation be extended to existing TLDs?	
B2	Both the SubPro PDP and the Staff Paper recommend that variant TLDs be operated by the same back-end registry service provider, the organization providing one or more registry services (e.g., DNS, DNSSEC, RDDS, EPP) for a registry operator. Should this recommendation be extended to existing TLDs and their variant TLD labels?	The SubPro PDP and Staff Paper recommendations must be extended to existing IDN gTLDs and their variant labels.
B3	Beyond having the same Registry Operator and same back-end registry service provider, as referenced in B1 and B2 , is there a need for additional constraints for the same entity requirement for the top-level? ²⁶⁷ If so, the rationale must be clearly stated.	There was no need for additional constraints for the “same entity” requirement for the top-level beyond the current EPDP-IDNs Phase 1 preliminary recommendations and implementation guidance.
B4	The policy recommendation advises that variant TLD labels be allocated to the same entity, however a process to apply for a variant TLD does not exist. The WG and the SubPro IRT to coordinate and consider the following questions in order to develop a consistent solution: what should an application process look like in terms of timing and sequence for an existing and future Registry Operator with respect to applying or activating their allocatable variant TLD labels?	<ul style="list-style-type: none"> ● During a new gTLD application process, an application for an IDN gTLD string may contain one of the following three options: <ol style="list-style-type: none"> 1) a primary IDN gTLD string only; OR 2) a primary IDN gTLD string and one or more of its allocatable variant label(s); OR

²⁶⁶ See Recommendation 25.5 in the SubPro PDP Final Report, p.115: <https://gnso.icann.org/sites/default/files/file/field-file-attach/final-report-newgtld-subsequent-procedures-pdp-02feb21-en.pdf#page=115>; Recommendation 2 in the Staff Paper, p.3: <https://www.icann.org/en/system/files/files/idn-variant-tld-recommendations-analysis-25jan19-en.pdf#page=3>; rationale for Recommendation 25.5 in the SubPro PDP Final Report, p.117: <https://gnso.icann.org/sites/default/files/file/field-file-attach/final-report-newgtld-subsequent-procedures-pdp-02feb21-en.pdf#page=117>; Section 3.2 in the Staff Paper, pp.6-7: <https://www.icann.org/en/system/files/files/idn-variant-tld-recommendations-analysis-25jan19-en.pdf#page=6>

²⁶⁷ The initial set of IDN variant TLD variant label management recommendations proposed for Public Comment also required that the IDN variant TLD variant labels be implemented using the same nameservers, unless otherwise justified. However, that recommendation is now removed based on the feedback received by the community asking for more operational flexibility in the implementation of IDN variant TLD variant labels.

#	Charter Question	EPDP Team Agreed to the Following:
		<p>3) one or more allocatable variant label(s) of an already delegated IDN gTLD.</p> <ul style="list-style-type: none"> ● An application for an allocatable variant label cannot precede an application for that variant label’s primary IDN gTLD. ● An application for an allocatable variant label of a delegated IDN gTLD must be submitted during an application round. ● The delegation timeframe for a primary IDN gTLD and its allocatable variant label(s) that pass evaluation is as affirmed by SubPro Affirmation 40.1 and Affirmation 40.2. Extension to the timeframe must also be available for both the primary IDN gTLD and/or the variant label(s) according to the same terms and conditions as affirmed by SubPro. ● The sequence for delegating applied-for primary IDN gTLD string and the allocatable variant label(s) that pass evaluation should not be mandated by policy.
B4a	<p>For the variant labels with status “withheld for the same entity” (i.e. not requested for allocation in the application process), what role do they play?</p>	<p>The EPDP Team interpreted the question as follows: “What role do the non-applied-for allocatable variant labels play in the application process?” It is only when an applied-for primary gTLD string is allocated or delegated as a result of the application being approved that its non-applied-for allocatable variant label(s) become “withheld for the same entity”.</p> <p>The non-applied-for allocatable variant labels will be taken into account in at least three aspects of the evaluation process for new gTLD applications: 1) String Similarity Review, 2) String Confusion Objection, and</p>

#	Charter Question	EPDP Team Agreed to the Following:
		3) Contention Resolution. See details explained in Preliminary Recommendation 4.1-4.4, 5.2-5.3, 6.1-6.2.
B5	Do restrictions that apply to a TLD (e.g., community TLDs, dot brand TLDs) also apply to its variants? Are these labels equally treated as different versions of the same string, or completely independent strings not bound by the same restrictions?	<ul style="list-style-type: none"> Any applied-for allocatable variant labels of an existing IDN gTLD from the 2012 round or any future applied-for primary IDN gTLD string sought by the applicant must be bound by the same restrictions as those for the primary IDN gTLD. An applied-for allocatable variant label must be subject to the same application requirements and evaluation criteria as the associated primary IDN gTLD string.
D1a	A TLD is subject to a Registry Agreement with ICANN. In case of IDN variant TLDs, ICANN would execute the Registry Agreement with the same entity but potentially diverge in future Registry Agreement amendments, addendums, and renewals. Should each TLD label be the subject of a separate Registry Agreement with ICANN? ²⁶⁸ If not, should each TLD label along with its variant labels be subject to one Registry Agreement with the same entity? Rationale for such definition must be clearly stated along with the answer, including goals and motivations.	<ul style="list-style-type: none"> Each future IDN gTLD and its variant labels (if any) must be subject to one Registry Agreement with the same registry operator. Any existing IDN gTLD registry operator from the 2012 round that applies for its variant labels must be required to enter into a separate, new Registry Agreement for the newly approved variant labels, while maintaining the existing Registry Agreement for its existing IDN gTLD.
D1b	What should be the process by which an existing registry operator could apply for, or be allocated, a variant for its existing gTLD? What should be the process by which an applicant applying for a new IDN	<ul style="list-style-type: none"> The most expedient and cost-effective path forward for existing registry operators from the 2012 round to apply for variant labels of their existing IDN gTLDs is through the next

²⁶⁸ Based on the premise that an IDN gTLD variant TLD label is a gTLD label with its status indistinguishable from any other gTLD label in the root zone, the Staff Paper recommends that each gTLD variant label TLD would be the subject of a separate Registry Agreement with ICANN, as each gTLD variant label TLD is, in effect, a gTLD. See Section 3.6 in the Staff Paper, p.15: <https://www.icann.org/en/system/files/files/idn-variant-tld-recommendations-analysis-25jan19-en.pdf#page=15>

#	Charter Question	EPDP Team Agreed to the Following:
	<p>gTLD could seek and obtain any allocatable variant(s)? What should be the associated fee(s), including the application fees and annual registration fees for variant TLDs? Should any specific implementation guidance be provided?²⁶⁹</p>	<p>application round of the New gTLD Program. No separate process should be developed for this purpose.</p> <ul style="list-style-type: none"> ● As a one-time exception for the immediate next application round, all applications for variant labels of existing IDN gTLDs from the 2012 round must receive priority in processing order ahead of all other new gTLD applications, including IDN gTLD applications that are subject to the prioritization draw order. ● Future applicants will only be required to submit one application for the primary IDN gTLD string and the allocatable variant labels sought by the applicant at that point in time. The applicant is required to demonstrate to the evaluator, via its response to additional application questions, that it needs and can manage both the primary IDN gTLD string and the applied-for allocatable variant label(s). ● The cost recovery principle reflected in the 2012 Applicant Guidebook and affirmed by the SubPro PDP must also apply to future IDN gTLD applications that include variant label(s), as well as applications for allocatable variant label(s) of existing IDN gTLDs from existing registry operators from the 2012 round.

²⁶⁹ SubPro PDP did not have substantive discussion about this question. Some SubPro PDP members believe that allocatable variant labels gTLDs should be made available to IDN gTLD registry operators and applicants, with only limited procedures and costs in place. As these deliberations arose late in the SubPro PDP’s life cycle, the group elected to only recommend the “same entity” principle for gTLD variant labels but refrained from providing recommendations on how gTLD variant labels can be obtained. However, SubPro includes in its recommendation that the “same entity” policy for the top-level must be captured in the relevant Registry Agreement. See Rationale for Recommendation 25.5 in the SubPro PDP Final Report, p.117: <https://gnso.icann.org/sites/default/files/file/field-file-attach/final-report-newgtld-subsequent-procedures-pdp-02feb21-en.pdf#page=117> and Recommendation 25.5 in the SubPro PDP Final Report, p.115: <https://gnso.icann.org/sites/default/files/file/field-file-attach/final-report-newgtld-subsequent-procedures-pdp-02feb21-en.pdf#page=115>

#	Charter Question	EPDP Team Agreed to the Following:
		<ul style="list-style-type: none"> ● As a one-time exception for the immediate next application round, the base application fee must be waived for an existing registry operator from the 2012 round applying for up to four (4) allocatable variant labels of an existing IDN gTLD. ● A future gTLD applicant applying for a primary IDN gTLD string and up to four (4) of its allocatable variant labels during an application round must incur the same base application fee as any gTLD applicant who does not apply for variant labels in that round. ● If the applied-for allocatable variant labels in an application exceed the threshold number of four (4), ICANN org should assess the impact of evaluating the additional labels and may charge additional fees considered proportionate to any additional evaluation costs and consistent with the cost recovery principle. This also applies to existing registry operators from the 2012 round. ● An application for only the variant label(s) of a delegated primary IDN gTLD must incur a discounted base application fee that ICANN org considers to be proportionate to any costs associated with evaluating the application and consistent with the cost recovery principle. This also applies to an existing registry operator from the 2012 round if it applies for allocatable variant labels of its existing IDN gTLD in any application round subsequent to the immediate next application round.

#	Charter Question	EPDP Team Agreed to the Following:
		<ul style="list-style-type: none"> ● One registry fixed fee must cover all of the delegated gTLD label(s) of a variant label set. ● The calculation of the registry-level transaction fee must be based on cumulative domain name registrations of the combined delegated gTLD label(s) from a variant label set.
D2	<p>In order to ensure that the same entity principle is maintained for a gTLD and its allocated variant TLD labels, what are the operational and legal impacts to the:</p> <ul style="list-style-type: none"> ● Registry Transition Process or Change of Control in the Registry Agreement;²⁷⁰ ● Emergency Back-End Registry Operator (EBERO) provisions; and ● Reassignment of the TLD as a result of the Trademark Post-Delegation Dispute Resolution Procedure (TM-PDDRP)?²⁷¹ 	<p>In the event of a registry transition, EBERO process, and reassignment of a gTLD as a result of the TM-PDDRP determination, an IDN gTLD and all of its allocated and delegate variant label(s) (if any) must undergo the same transition process together to maintain the “same entity” requirement and remain linked contractually.</p>

²⁷⁰ The Staff Paper recommends that each set of registry agreement(s) must contain provisions requiring all the labels in the Internationalized Domain Label (IDL) set to follow the same process in the event of any registry transition via a Registry Transition Process or Change of Control. In no event, should the composition of the allocated and delegated set of gTLD variant labels be allowed to change at the same time as the change of the Registry Operator. The SubPro PDP also agrees that to the extent that the gTLD were to change hands at any point after delegation, the gTLD variant labels must remain linked contractually, which should be considered a persistent requirement (e.g., this would impact gTLD registry transition procedures). See Section 3.6 in the Staff Paper, p.15:

<https://www.icann.org/en/system/files/files/idn-variant-tld-recommendations-analysis-25jan19-en.pdf#page=15> and Rationale for Recommendation 25.5 in the SubPro PDP Final Report, p.117: <https://gnso.icann.org/sites/default/files/file/field-file-attach/final-report-newgtld-subsequent-procedures-pdp-02feb21-en.pdf#page=117>

²⁷¹ The Staff Paper recommends that an emergency transition of a gTLD to an EBERO provider must trigger an emergency transition of all gTLD variant labels to the EBERO provider. In addition, the SubPro PDP also agrees that EBERO would be impacted due to the persistent requirement of ensuring that gTLD variant labels must remain linked contractually. See Section 3.6 in the Staff Paper, p.16: <https://www.icann.org/en/system/files/files/idn-variant-tld-recommendations-analysis-25jan19-en.pdf#page=16> and Rationale for Recommendation 25.5 in the SubPro PDP Final Report, p.117: <https://gnso.icann.org/sites/default/files/file/field-file-attach/final-report-newgtld-subsequent-procedures-pdp-02feb21-en.pdf#page=117>. In the case where a Registry Agreement is terminated as a result of a TM-

#	Charter Question	EPDP Team Agreed to the Following:
D3	<p>In order to ensure that the same entity principle is maintained, what are the operational and legal impacts to the data escrow policies, if any.²⁷²</p>	<ul style="list-style-type: none"> Existing data escrow requirements for existing gTLDs must apply to IDN gTLDs and variant labels as provided for in the Registry Agreement. The same data escrow agent must be contracted for the IDN gTLD and its allocated and delegated variant label(s). The escrow data associated with each gTLD variant label should be stored in separate files.
D8	<p>What additional updates to the Registry Agreement are necessary to ensure the labels under variant TLDs follow the “same entity” rule? For example, the Staff Paper recommends that the following requirements must be included in the Registry Agreement; some of the charter questions are also related to those topics:²⁷³</p> <ul style="list-style-type: none"> Subordinate names allocated by the Registry Operator in the TLD be treated as an atomic set. This is true irrespective of whether any of the names is actually activated in the DNS, and whether any of the variants is actually registered. [related to questions C1, D4, D5] 	<ul style="list-style-type: none"> A primary IDN gTLD cannot be subject to removal from the root zone without affecting its variant label(s). If a primary IDN gTLD is removed, its delegated variant label(s) must also be removed. In the event that a registry operator requests to have its variant label removed from the root zone and as such is no longer delegated, the delegated primary IDN gTLD and its other delegated variant label(s) need not be removed from the root zone. However, in the event a label, whether a primary label or a variant label, is removed from the root zone as a consequence of its registry operator’s breach of the Registry Agreement, its

PDDRP determination, this would trigger the Registry Transition Procedure and various outcomes could apply. The Staff Paper notes that in the case of a reassignment of the gTLD, the “same entity” rule should continue to apply so that the gTLD variant labels would be assigned to the same entity together. See Section 3.7 in the Staff Paper, p.18: <https://www.icann.org/en/system/files/files/idn-variant-tld-recommendations-analysis-25jan19-en.pdf#page=18>

²⁷² Data escrow is the act of storing data with a neutral third party in case of registry or registrar failure, accreditation termination, or accreditation relapse without renewal. ICANN requires all registrars and gTLD registries to contract with a data escrow provider in order to safeguard registrants. Because each variant label of the IDL set is just another registration, data escrow policies for TLDs apply individually to each. The Staff Paper notes that the data escrow requirements are automatically satisfied for gTLD variant labels. See Section 3.9.2 in the Staff Paper, p.22: <https://www.icann.org/en/system/files/files/idn-variant-tld-recommendations-analysis-25jan19-en.pdf#page=22>

²⁷³ Section 3.6 in the Staff Paper, p.16: <https://www.icann.org/en/system/files/files/idn-variant-tld-recommendations-analysis-25jan19-en.pdf#page=16>:

#	Charter Question	EPDP Team Agreed to the Following:
	<ul style="list-style-type: none"> ● All the different IDN tables being used by the IDN gTLD and its variant gTLDs be harmonized. [related to questions C4, C5] ● All the IDN variant TLDs be implemented through the same registry service provider, to promote a consistent and stable implementation across all such variant TLDs. [related to questions B2, B4] <p>Are there any additional updates that need to be considered that are not included in this list?</p>	<p>associated variant label set must also be removed from the root zone.</p>
E1	<p>In considering the conclusion(s) with respect to question B4a, what role, if any, do TLD labels “withheld for possible allocation” or “withheld for the same entity” play vis-a-vis:</p> <ul style="list-style-type: none"> ● objection process; and ● string similarity review process? 	<p>The EPDP Team interpreted the question as follows: “What role do the non-applied-for allocatable variant labels play in the application process?” It is only when an applied-for primary gTLD string is allocated or delegated as a result of the application being approved that its non-applied-for allocatable variant label(s) become “withheld for the same entity”.</p> <p>The non-applied-for allocatable variant labels will be taken into account in at least three aspects of the evaluation process for new gTLD applications: 1) String Similarity Review, 2) String Confusion Objection, and 3) Contention Resolution. See details explained in Preliminary Recommendation 4.1-4.4, 5.2-5.3, 6.1-6.2.</p>
E2	<p>Under the rules of the most recent gTLD application round, there are four criteria for objections to a string (see gTLD Applicant Guidebook, version 2012-06-04, section 3.2.1).²⁷⁴ The SubPro PDP has also affirmed the continuation of these four</p>	<ul style="list-style-type: none"> ● All applied-for allocatable gTLD variant labels must be subject to the objection processes. ● With respect to the String Confusion Objection:

²⁷⁴ The four criteria are: String Confusion Objection; Legal Rights Objection; Limited Public Interest Objection; and Community Objection.

#	Charter Question	EPDP Team Agreed to the Following:
	<p>criteria for objections to a string, while proposing recommendations and implementation guidance to enhance / adjust these criteria.²⁷⁵ The WG and the SubPro IRT to coordinate to ensure consistency in the implementation of the objection process for the variant label applications of existing and future TLDs.</p>	<ul style="list-style-type: none"> ○ An objection may be filed based on confusing similarity between combinations of applied-for primary gTLD strings and their variant labels established by <u>Preliminary Recommendation 4.1-4.2</u>. ○ Consistent with the outcomes set out in the 2012 Applicant Guidebook as they apply to a String Confusion Objection: <ul style="list-style-type: none"> ■ If the objection prevails and where the objector is an existing TLD registry operator, then that application (in its entirety) is ineligible to proceed to the next stage of the application process; or ■ If objection prevails and where the objector is another applicant, then both that application and the objector’s application are placed in a contention set. ■ If the objection does not prevail, then that application (in its entirety) may proceed to the next stage of the application process. ● With respect to the Limited Public Interest Objection, Legal Rights Objection, and Community Objection: <ul style="list-style-type: none"> ○ An objection may only be filed against the applied-for primary

²⁷⁵ See “Topic 31: Objections” in the SubPro PDP Final Report, pp.145-154:
<https://gnso.icann.org/sites/default/files/file/field-file-attach/final-report-newgtld-subsequent-procedures-pdp-02feb21-en.pdf#page=145>

#	Charter Question	EPDP Team Agreed to the Following:
		<p>gTLD strings and/or the applied-for allocatable variant labels.</p> <ul style="list-style-type: none"> ○ Generally consistent with the outcomes set out in the 2012 Applicant Guidebook as they apply to a Limited Public Interest Objection, or a Legal Rights Objection, or a Community Objection: <ul style="list-style-type: none"> ■ If an objection against an applied-for primary gTLD string prevails, then that application (in its entirety) is ineligible to proceed to the next stage of the application process. ■ If an objection against only one or more applied-for allocatable variant label(s) prevails, then that application for the applied-for primary gTLD string and other unaffected applied-for allocatable variant label(s) may proceed to the next stage of the application process without the applied-for allocatable variant label(s) which are rendered ineligible by the objection. ■ If the objection does not prevail, then that application (in its entirety) may proceed to the next stage of the application process.
E3	<p>In the Initial Evaluation for new gTLD applications, a proposed applied-for TLD is checked against several criteria as part of the string similarity review process (see gTLD Applicant Guidebook, version 2012-</p>	<ul style="list-style-type: none"> ● The String Similarity Review process for all applied-for gTLD strings (including all ASCII and IDN strings) and variant labels should strike a balance between permitting the delegation of gTLD variant labels that

#	Charter Question	EPDP Team Agreed to the Following:
	<p>06-04, section 2.2.1.1.1).²⁷⁶ The SubPro PDP affirmed these standards, while proposing recommendations and implementation guidance to enhance the process.²⁷⁷ The WG and the SubPro IRT to coordinate to ensure consistency in the implementation of the string similarity review procedure for variant label applications of existing and future gTLDs.²⁷⁸</p>	<p>meet user needs and limiting potential security and stability risks associated with such delegation.</p> <ul style="list-style-type: none"> ● At a minimum, the String Similarity Review must compare an applied-for primary gTLD string (no matter whether it is an ASCII string or an IDN string) and all of its allocatable and blocked variant labels against the following, with the exclusion of comparing a blocked variant label against other blocked variant labels: <ul style="list-style-type: none"> ○ all existing gTLDs and ccTLDs and all of their allocatable and blocked variant labels; and ○ requested ccTLD strings and all of their allocatable and blocked variant labels; and

²⁷⁶ These criteria are: existing TLDs and reserved names; other applied-for gTLD strings; strings requested as IDN ccTLDs; and applied-for 2-character IDN gTLD strings against every other single character and any other 2-character ASCII string.

²⁷⁷ See “Topic 24: String Similarity Evaluations” in the SubPro PDP Final Report, pp.108-114:

<https://gns0.icann.org/sites/default/files/file/field-file-attach/final-report-newgtd-subsequent-procedures-pdp-02feb21-en.pdf#page=108>

²⁷⁸ The Staff Paper recommends that the string similarity process compares strings under consideration not just against all allocated or applied-for gTLD strings, but also all variant labels of those strings (including allocatable, withheld-same-entity, and blocked). For example, if a string is merely withheld-same-entity and a second string is visually similar, then allocating the second string undermines the predictability of the outcome of variant processing from the RZ-LGR. Similarly, if a string is blocked under the RZ-LGR, but a visually similar string is allocatable, then the second (visually similar) string might become a “work around” for the blocked string. This approach is maximally conservative. It is nevertheless worth noting that this expands considerably the number of strings that might need to be considered; the entire similarity review process will consequently probably become more expensive to operate. See Section 3.8 Adjustments in String Similarity Process in the Staff Paper, pp.18-19:

<https://www.icann.org/en/system/files/files/idn-variant-tld-recommendations-analysis-25jan19-en.pdf#page=18>

Staff Paper further recommends that in the event that two or more applied-for variant labels are visually similar, they may only be allocated if they are associated with the same variant set and are being requested by the same entity. In case of such conflicts across variant labels, the entire IDL set gets processed as one contention set; if one of the labels is already allocated, the contention is resolved in favor of the current operator. The Staff Paper recommends that it is necessary to perform the visual similarity checks for every requested-to-be-allocated variant in any given set against all the possible variant labels in every other set. This is because such an available variant could be requested at any time in the future. See Section 3.8.1 in the Staff Paper, pp.20-21: <https://www.icann.org/en/system/files/files/idn-variant-tld-recommendations-analysis-25jan19-en.pdf#page=20>

#	Charter Question	EPDP Team Agreed to the Following:
		<ul style="list-style-type: none"> ○ other applied-for gTLD strings and all of their allocatable and blocked variant labels; and ○ any other two-character ASCII strings (if the applied-for gTLD string is a two-character string) and all of their allocatable and blocked variant labels; and ○ all strings on the Reserved Names list and all of their allocatable and blocked variant labels. ● As an exception, the String Similarity Review Panel may, in line with guidelines and/or criteria to be developed during implementation, decide whether and what blocked variant labels to omit when conducting a comparison on the basis of a manifestly low level of visual confusability between the scripts of labels being compared.²⁷⁹
E3a	<p>After a requested variant string is rejected as a result of a string similarity review, should the other variant strings in the same variant set remain allocatable? Should individual labels be allowed to have different outcomes/actions (e.g., some labels be blocked and some be allowed to continue with an application process)?²⁸⁰</p>	<ul style="list-style-type: none"> ● All labels from a variant label set, comprising the primary gTLD string and all of its allocatable and blocked variant labels, must be treated as one unit and share the same outcome out of the String Similarity Review.

²⁷⁹ In the context of preliminary recommendations in this Phase 1 Initial Report, a “blocked” label refers to either: 1) a label within the same script that is deemed valid as a top-level domain by the RZ-LGR but unavailable for allocation or delegation; or 2) a mixed-script blocked label permitted by the RZ-LGR as an exception (i.e., only Japanese has such an exception). To be clear, the “blocked” variant labels in this Phase 1 Initial Report do not include the labels created by mixing different scripts. Such mixed-script labels are not eligible to be top-level domains with the exception of Japanese.

²⁸⁰ The Staff Paper recommends that the following outcomes may be considered: 1) only the variant label requested for delegation is rejected. For example, the requested variant t1v2 of top-level label t1 will get rejected while t1v1 and t1v3 from the same variant set continue to remain allocatable; or 2) the entire variant set is rejected. For example, the requested variant t1v2 of top-level label t1 will get rejected including t1v1 and t1v3 from the same variant set as t1v2. This outcome appears to be difficult to justify, though an applicant could decide that, if it cannot receive t1v2 then it does not wish to proceed with the application. See Section 3.8.2 in the Staff Paper, pp.21: <https://www.icann.org/en/system/files/files/idn-variant-tld-recommendations-analysis-25jan19-en.pdf#page=21>

#	Charter Question	EPDP Team Agreed to the Following:
		<ul style="list-style-type: none"> Existing mechanisms in the New gTLD Program can be leveraged to dispute the outcomes of the String Similarity Review.
E4	<p>Under current procedures, resolution of string contention for applied for gTLD strings may include components such as a settlement between the parties, a community priority evaluation (if a community-based applicant in a contention set elects this option), and an auction. SubPro PDP affirmed these components while proposing recommendations and implementation guidance to enhance the mechanisms for string contention resolution.²⁸¹ The WG and the SubPro IRT to coordinate to ensure consistency in the implementation of the string contention resolution mechanism for variant label applications of existing and future new gTLDs.²⁸²</p>	<ul style="list-style-type: none"> An applied-for primary gTLD string that is also a variant label of another applied-for primary gTLD string, as calculated by the RZ-LGR, must be placed in a contention set. The entire variant label set of an applied-for primary gTLD string must be processed in the contention set, as opposed to only the applied-for primary gTLD string.
E5	<p>The WG and the SubPro IRT to coordinate and consider the following questions in order to develop a consistent solution: should the reserved strings ineligible for delegation for existing and future gTLDs be updated to include any possible variant labels? Consider this question by taking into account the data to be collected in the “Data and Metric Requirements” section of this charter.</p>	<ul style="list-style-type: none"> This charter question is intended to address two issues: 1) Reserved Names and 2) Strings Ineligible for Delegation. The Reserved Names list must not be expanded to include variant labels. All variant labels of Reserved Names cannot be applied for.

²⁸¹ See “Topic 35” in the SubPro PDP Final Report, pp. 173-182: <https://gnso.icann.org/sites/default/files/file/field-file-attach/final-report-newgtld-subsequent-procedures-pdp-02feb21-en.pdf#page=173>

²⁸² For contention issues that involve the same entity, the Staff Paper suggests that the following resolution options may be considered, with a preference to the second option: 1) When the requested variant labels are placed in a contention set for later evaluation, the applicant is notified of the contention set and has the opportunity to establish that both applications are from the same entity. 2) It may be more efficient to establish early on in the string similarity review that the variant labels are being requested by the same entity prior to reaching the contention phase. See Section 3.8.2 in the Staff Paper, p. 21: <https://www.icann.org/en/system/files/files/idn-variant-tld-recommendations-analysis-25jan19-en.pdf#page=21>

#	Charter Question	EPDP Team Agreed to the Following:
		<ul style="list-style-type: none"> • The list of Strings Ineligible for Delegation must not be expanded to include variant labels. • Only the protected organizations on the list of Strings Ineligible for Delegation are allowed to apply for their respective protected string(s) and allocatable variant label(s) at the top-level.²⁸³
E6	<p>The WG and the SubPro IRT to coordinate and consider the following questions in order to develop a consistent solution: is there any reason to permit the registration of gTLDs consisting of decorated two-character Latin labels which are not variant labels of any two-letter ASCII labels?²⁸⁴ If so, rationale must be clearly stated.</p>	<p>The EPDP Team noted that the standard used in the String Similarity Review from the 2012 round will continue in the future rounds, per SubPro Affirmation 24.2.²⁸⁵ Specifically, an applied-for two-character gTLD string, regardless of script or language, will be reviewed for visual similarity to any two-character ASCII combination in order to protect possible future ccTLD delegations. As such, the EPDP Team noted that an applied-for gTLD string consisting of decorated two-character Latin labels will be evaluated for visual similarity to any two-character ASCII combination. A string that does not pass the evaluation will not be able to proceed in the application process.</p> <p>EPDP Team agreed not to develop any additional recommendation on this topic but to rely on the existing process of using the String Similarity Review to catch any applied-for gTLD string in any script, not</p>

²⁸³ The entity that possesses the string ineligible for delegation is referred to as the “protected organization”, per Final Report on the Protection of IGO and INGO Identifiers in All gTLDs Policy Development Process:

https://gnso.icann.org/sites/default/files/filefield_42639/igo-ingo-final-10nov13-en.pdf

²⁸⁴ The ccTLD labels in the root depend on an external registry (ISO 3166) that allocates alphabetic codes to countries. In order to ensure that no conflicts with future assignments by ISO can happen, ICANN has traditionally also maintained a restriction against the use of two-letter TLDs for all Latin script letters; no variant labels should be generated for ccTLDs based on the ISO3166 codes. This principle is also reaffirmed by the SubPro PDP. See Recommendation 21.6 in the SubPro Final Report, p.95: <https://gnso.icann.org/sites/default/files/file/field-file-attach/final-report-newgtld-subsequent-procedures-pdp-02feb21-en.pdf#page=95>

²⁸⁵ See Affirmation 24.2 in the SubPro PDP Final Report, p.108: <https://gnso.icann.org/sites/default/files/file/field-file-attach/final-report-newgtld-subsequent-procedures-pdp-02feb21-en.pdf#page=108>

#	Charter Question	EPDP Team Agreed to the Following:
		limited to the Latin script, that may be potentially confusable with a two-character ASCII combination. The EPDP Team noted that such confusability issues may also exist in other scripts, such as Cyrillic, Ethiopic, Gujarati, Hebrew, and Malayalam scripts. ²⁸⁶
E7	<p>Besides the objection process, string similarity review, and string contention resolution, what other ICANN policies and procedures should be updated to enforce the “same entity” rule and the use of RZ-LGR as the sole source to calculate the variant Labels and disposition values?²⁸⁷ See the list of ICANN Consensus Policies here:</p> <p>https://www.icann.org/resources/pages/registrars/consensus-policies-en</p>	<p>An EPDP Team member suggested that the group consider whether additional recommendations are needed with respect to the treatment of singular/plural versions of an applied-for primary gTLD string and its variant label(s) in the String Similarity Review. The EPDP Team reviewed SubPro PDP Outputs regarding the singular/plural issues, specifically the SubPro PDP Recommendation 24.3, Implementation Guidance 24.4, and Recommendation 24.5.²⁸⁸ While the EPDP Team reaffirmed the SubPro PDP Outputs, some members questioned why the Outputs are limited to singular/plural issues but not other morphological phenomena. Other members also raised questions on how the SubPro PDP Outputs would be put into practice. Nevertheless, the EPDP Team agreed that those issues are out of scope for the EPDP Team but would instead be addressed during the implementation of the SubPro PDP Outputs. The EPDP Team also agreed that no additional recommendations need to be developed to address the singular/plural issues to complement its recommendations for the String Similarity Review (see Preliminary Recommendation 4.1-4.3).</p>

²⁸⁶ The EPDP Team reviewed examples in those scripts during its meeting on 10 November 2022. See slides here: <https://community.icann.org/download/attachments/218465843/EPDP%20Team%20Meeting%20%2357%20Slides%20-%20E2%2C%20E6.pdf?version=1&modificationDate=1668108498000&api=v2>

²⁸⁷ IDN Variant TLD Implementation Staff Paper: <https://www.icann.org/en/system/files/files/idn-variant-tld-recommendations-analysis-25jul18-en.pdf>

²⁸⁸ See details in the SubPro PDP Final Report, pp.108-111: <https://gnso.icann.org/sites/default/files/file/field-file-attach/final-report-newgtld-subsequent-procedures-pdp-02feb21-en.pdf#page=108>

11 Annex E – Background

This section summarizes key milestones related to the introduction of Internationalized Domain Names (IDNs) and their variant labels at the top and second levels. While variant management is an important concept relating to IDNs and therefore this section focuses on the background of IDNs, the EPDP-IDNs Phase 1 final recommendations, with the exception of [Final Recommendations 3.14-3.15](#), apply to all gTLD variant labels, including both ASCII and IDNs.

2003: IDN Registrations at the Second-Level

In 2003, the Internet Engineering Task Force (IETF) developed IDNA2003, the standard which first enabled domain names to contain non-ASCII Unicode characters. In the same year, ICANN and leading Internationalized Domain Name (IDN) registries collaboratively developed IDN Implementation Guidelines version 1.0, which were then endorsed by the ICANN Board.²⁸⁹ ICANN subsequently began authorizing registries having agreements with ICANN to deploy IDNs at the second level according to the provisions of the Guidelines.

2007: Groundwork for IDN gTLDs at the Top-Level

In 2007, the GNSO's Final Report on Introduction of New Generic Top-Level Domains included the following outputs on IDNs, laying the groundwork for the introduction of IDN gTLDs:²⁹⁰

- Principle B: Some new generic top-level domains should be internationalized domain names (IDNs) subject to the approval of IDNs being available in the root.
- Principle C: The reasons for introducing new top-level domains include that there is demand from potential applicants for new top-level domains in both ASCII and IDN formats.
- Recommendation 18: If an applicant offers an IDN service, then ICANN's IDN Guidelines must be followed.

2009: Introduction of IDN ccTLDs at the Top-Level

In 2009, the ICANN Board approved the Final Implementation Plan for the ccTLD Fast Track Process, which was based on a proposal produced by the Internationalized Domain Names Working Group (INDC WG).²⁹¹ The Fast Track Process enabled countries and territories to submit

²⁸⁹ IDN Implementation Guidelines version 1.0: <https://www.icann.org/resources/pages/idn-guidelines-2003-06-20-en>; ICANN Board resolution that endorsed the IDN Implementation Guidelines: <https://www.icann.org/en/board-activities-and-meetings/materials/minutes-regular-meeting-of-the-board-rio-de-janeiro-27-03-2003-en#InternationalizedDomainNames>

²⁹⁰ Final Report on Introduction of New Generic Top-Level Domains: <https://gns0.icann.org/en/issues/new-gtlds/pdp-dec05-fr-part08aug07.htm>

²⁹¹ Final Implementation Plan for the ccTLD Fast Track Process: <https://www.icann.org/en/system/files/files/idn-ccTld-implementation-plan-16nov09-en.pdf>; ICANN Board resolution that approved the Fast Track Process implementation plan: <https://www.icann.org/en/board-activities-and-meetings/materials/approved-resolutions-regular-meeting-of-the-icann-board-of-directors-seoul-30-10-2009-en#2>; INDC WG: <https://ccnso.icann.org/en/workinggroups/idncwg.htm>

requests to ICANN for IDN ccTLDs representing their respective country or territory names in scripts other than Latin, introducing IDNs to the top level for the first time. To date, 61 IDN ccTLDs have been delegated.

2010: No Top-Level Variant gTLDs Delegated in the New gTLD Program

In 2010, as preparations were underway for the launch of the New gTLD Program, the ICANN Board resolved that “...no variants of gTLDs will be delegated through the New gTLD Program until appropriate variant management solutions are developed.”²⁹² The Board directed ICANN’s CEO to develop an issues report “identifying what needs to be done with the evaluation, possible delegation, allocation and operation of gTLDs containing variant characters IDNs as part of the new gTLD process in order to facilitate the development of workable approaches to the deployment of gTLDs containing variant characters IDNs.”²⁹³

2012: “Gaps” with Respect to IDN Variant TLDs

In 2012, the IDN Variant Issues Project produced A Study of Issues Related to the Management of IDN Variant TLDs (Integrated Issues Report), which collated issues associated with the possible inclusion in the DNS root zone of IDN variant TLDs.²⁹⁴ The study identified two gaps:

1. No definition of IDN variant TLDs.
2. No IDN variant TLD management mechanism.

2012: New gTLD Program 2012 Round: IDNs at the Top-Level

Also in 2012, the New gTLD Program launched, providing the first opportunity to apply for IDN gTLDs. A total of 116 IDN gTLD applications were received during the 2012 application round. Ninety-two (92) IDN gTLDs were ultimately delegated. While variant gTLDs were not delegated as part of the 2012 round, applicants were invited to declare any variants of the applied-for string in the application. Declaring variant strings was for information purposes only and did not imply any right or claim to the declared variant strings.

2013: Procedure for Developing Root Zone Label Generation Rules

In 2013, the ICANN Board resolved to implement the procedure for developing Root Zone Label Generation Rules (RZ-LGR), which aimed to address the previously identified gap 1 that there

²⁹² ICANN Board resolution regarding gTLD variant labels: <https://www.icann.org/en/board-activities-and-meetings/materials/approved-resolutions-special-meeting-of-the-board-of-directors-25-09-2010-en#2.5>

²⁹³ Ibid.

²⁹⁴ Integrated Issues Report: <https://www.icann.org/en/system/files/files/idn-vip-integrated-issues-final-clean-20feb12-en.pdf>

was no definition of IDN variant TLDs.²⁹⁵ Generation Panels started developing proposals for script-specific Label Generation Rules (LGR) that define a set of parameters that determine valid IDN labels and their variants for the root zone.²⁹⁶

2019: Recommendations for Variant TLD Management

In 2019, to address the previously identified gap 2 that there was no IDN variant management mechanism, ICANN org published Recommendations for Managing Internationalized Domain Name Variant Top-Level Domains (“Staff Paper”), which the Board subsequently approved.²⁹⁷ In its resolution approving the Staff Paper, the Board requested “that the ccNSO and GNSO take into account the Variant TLD Recommendations while developing their respective policies to define and manage the IDN variant TLDs for the current TLDs as well as for future TLD applications.”

2020: Recommendations for the Technical Utilization of the RZ-LGR

In addition, to further address the gap 2 that there was no IDN variant management mechanism, the ICANN Board asked the ICANN community to study and recommend how to technically apply the RZ-LGR in a harmonized way to all TLDs. The RZ-LGR Technical Study Group (TSG) developed Recommendations for the Technical Utilization of the RZ-LGR, which the Board approved in 2020.²⁹⁸

2021: Recommendations for Future Rounds of the New gTLD Program

In February 2021, the GNSO New gTLD Subsequent Procedures (SubPro) Policy Development Process (PDP) Working Group published its Final Report, which includes hundreds of Outputs on 42 topics related to the future of the New gTLD Program.²⁹⁹ IDNs were addressed in Topic 25 of the Final Report.

²⁹⁵ Procedure for developing the RZ-LGR: <https://www.icann.org/en/system/files/files/lgr-procedure-20mar13-en.pdf>; ICANN Board resolution that adopted the procedure: <https://www.icann.org/en/board-activities-and-meetings/materials/approved-resolutions-regular-meeting-of-the-icann-board-of-directors-11-04-2013-en#2.a>

²⁹⁶ Learn more about the Generation Panels here: <https://www.icann.org/resources/pages/generation-panel-2015-06-21-en>

²⁹⁷ Staff Paper: <https://www.icann.org/resources/pages/idn-variant-tld-implementation-2018-07-26-en>; Board resolution that adopted the recommendations in the Staff Paper: <https://www.icann.org/en/board-activities-and-meetings/materials/approved-resolutions-regular-meeting-of-the-icann-board-14-03-2019-en#2.a>

²⁹⁸ Recommendations for the Technical Utilization of the RZ-LGR: <https://www.icann.org/en/system/files/files/rz-lgr-technical-utilization-recs-07oct19-en.pdf>; ICANN Board resolution that adopted the recommendations: <https://www.icann.org/en/board-activities-and-meetings/materials/approved-resolutions-open-session-of-board-workshop-los-angeles-regular-meeting-of-the-icann-board-26-01-2020-en#1.c>; TSG: <https://community.icann.org/display/croscomlgrprocedure/Study+Group+on+Technical+Use+of+RZ-LGR>

²⁹⁹ SubPro PDP Final Report: <https://gns0.icann.org/sites/default/files/file/field-file-attach/final-report-newgtld-subsequent-procedures-pdp-02feb21-en.pdf>

2021: Policy Development Related to IDN Variant TLDs

In May 2021, the GNSO approved the charter of the Expedited Policy Development Process (EPDP) on IDNs, which is expected to develop recommendations by building on the existing body of policy work, research, and analysis on the IDN subject.³⁰⁰ The EPDP Team began meeting in August 2021. The EPDP Team also established a small group dedicated to the deliberation on String Similarity Review-related charter questions.

In August 2021, the ccNSO Council approved the charter for the ccPDP4, which is tasked to recommend a policy for the selection and deselection of IDN ccTLD strings.³⁰¹ The outcomes of the ccPDP4 are expected to eventually replace the IDN ccTLD Fast Track Process. The ccPDP was chartered to include a sub-group specifically focused on variant management of IDN ccTLD strings, as well as a sub-group focused on the review of confusingly similar strings. Those topics overlap with the topics specified in the EPDP-IDNs charter.

Per the ICANN Board's request that the GNSO and the ccNSO keep each other informed of their respective progress in developing the relevant details of and policies and procedures on IDN variant TLD management, the EPDP Team and ccPDP4 have appointed liaisons to each other.³⁰² Both groups also meet periodically to discuss the alignment of their draft recommendations.

2022: ICANN Published RZ-LGR Version 5 and IDN Implementation Guidelines Version 4.1

In May 2022, ICANN published the Root Zone Label Generation Rules version 5, which covers 26 scripts: Arabic, Armenian, Bangla, Chinese (Han), Cyrillic, Devanagari, Ethiopic, Georgian, Greek, Gujarati, Gurmukhi, Hebrew, Japanese (Hiragana, Katakana, and Kanji [Han]), Kannada, Khmer, Korean (Hangul and Hanja [Han]), Lao, Latin, Malayalam, Myanmar, Oriya, Sinhala, Tamil, Telugu, and Thai.³⁰³

In November 2022, ICANN published IDN Implementation Guidelines version 4.1 after approval by the ICANN Board.³⁰⁴ The ICANN Board deferred implementation of guidelines 6a, 11, 12, 13,

³⁰⁰ EPDP-IDNs charter:

<https://gnso.icann.org/sites/default/files/policy/2021/presentation/CharterGNSOIDNsEPDPWorkingGroup20May21.pdf>

³⁰¹ ccPDP4 charter:

<https://community.icann.org/download/attachments/138969190/Draft%20Charter%20ccPDP4%20WG.pdf?version=1&modificationDate=1592141220002&api=v2>

³⁰² ICANN Board resolution that requested coordination between GNSO and ccNSO on the IDN related policy development: <https://www.icann.org/en/board-activities-and-meetings/materials/approved-resolutions-regular-meeting-of-the-icann-board-14-03-2019-en#2.a>

³⁰³ RZ-LGR version 5: <https://www.icann.org/resources/pages/root-zone-lgr-2015-06-21-en>

³⁰⁴ IDN Implementation Guidelines version 4.1: <https://www.icann.org/en/system/files/files/idn-guidelines-22sep22-en.pdf>; ICANN Board resolution that approved the IDN Implementation Guidelines version 4.1: <https://www.icann.org/en/board-activities-and-meetings/materials/approved-resolutions-regular-meeting-of-the-icann-board-22-09-2022-en#2.d>

18 in version 4.0 as they overlapped with ongoing work in the EPDP Team.³⁰⁵ The ICANN Board then directed ICANN org to publish the non-deferred guidelines in 4.0 as version 4.1.

2023: ICANN Board Kicked Off SubPro Implementation

In March 2023, during the ICANN76 Public Meeting, the ICANN Board adopted a substantial portion of the Outputs in the SubPro PDP Final Report and officially kicked off implementation efforts to prepare for launching the next application round of the New gTLD Program.³⁰⁶ The Outputs adopted by the ICANN Board include all the IDN recommendations in Topic 25 of the SubPro PDP Final Report. At the same time, the ICANN Board requested the EPDP Team to deliver an updated project plan by the last day of the ICANN77 Public Meeting (15 June 2023) that identifies all character questions that will impact the next Applicant Guidebook of the New gTLD Program, as well as a timeline for the EPDP Team's delivery of relevant recommendations to the GNSO Council. The GNSO Council submitted this deliverable to the ICANN Board during ICANN77 and provided an updated timeline in July 2023.³⁰⁷ The EPDP-IDNs Team is currently projected to complete its two phases of work by October 2024.

³⁰⁵ Proposed IDN Implementation Guidelines version 4.0: <https://www.icann.org/en/system/files/files/idn-guidelines-10may18-en.pdf>

³⁰⁶ ICANN Board resolution that partially adopted the SubPro PDP Outputs: <https://www.icann.org/en/board-activities-and-meetings/materials/approved-resolutions-regular-meeting-of-the-icann-board-16-03-2023-en>

³⁰⁷ See details in the GNSO Council deliverable submitted during ICANN77 here: <https://www.icann.org/en/system/files/correspondence/ducos-to-sinha-15jun23-en.pdf>; See the updated GNSO Council deliverable here: <https://www.icann.org/en/system/files/correspondence/ducos-to-sinha-25jul23-en.pdf>

12 Annex F – EPDP Team Membership and Attendance

The EPDP Team uses a “Representative + Open Model”, consisting of members, participants, and observers. For details of the role descriptions, please refer to the “Membership Structure” section in the EPDP Team charter included in Annex B of this report.

The members, participants, liaisons are listed below, along with their Statement of Interest (SOI) and attendance metrics. Note that this list was accurate as of the publication of this report. Some members and participants who initially joined the EPDP Team after it began meeting left during its deliberations.

Plenary Meetings:

- 104 Plenary calls (with 11 cancelled) for 158.5 call hours

String Similarity Review Small Group Meetings:

- 14 Small Group calls for 13.5 call hours

Leadership Meetings:

- 118 Leadership calls (with 11 cancelled) for 118.0 call hours

Overall Meeting Activities:

- 250 total calls (with 22 cancelled) for a total of 4170 person hours
- 55.1% attendance rate for total calls (58.3% for Plenary calls)

ICANN org Staff Support for the EPDP Team are listed below:

Substantive Support	Secretariat Support	ICANN Org Liaison
Ariel Liang	Devan Reed	Michael Karakash
Daniel Gluck	Julie Bisland	Pitinan Kooarmornpatana
Emily Barabas	Michelle DeSmyter	Sarmad Hussain
Steve Chan	Nathalie Peregrine	
	Terri Agnew	

EPDP Team Activity Metrics:

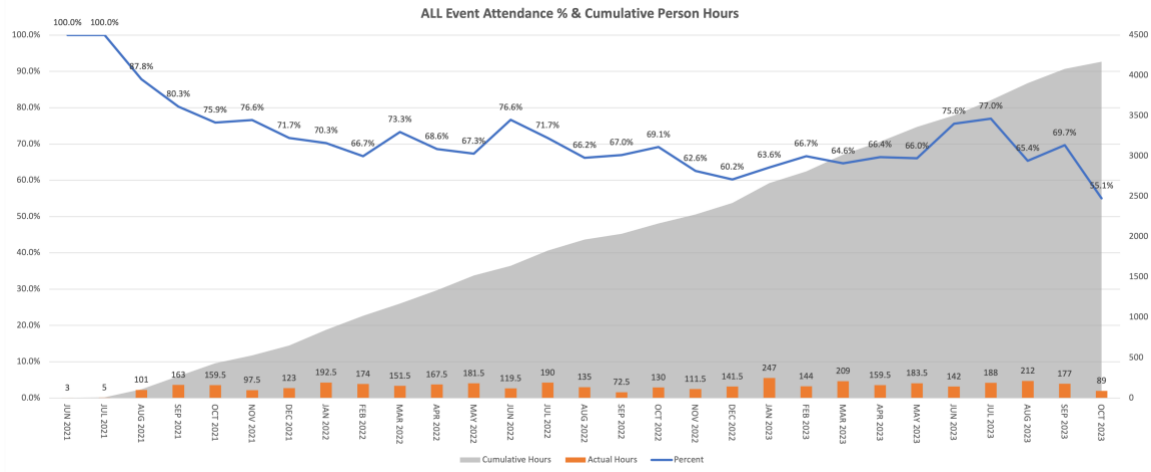
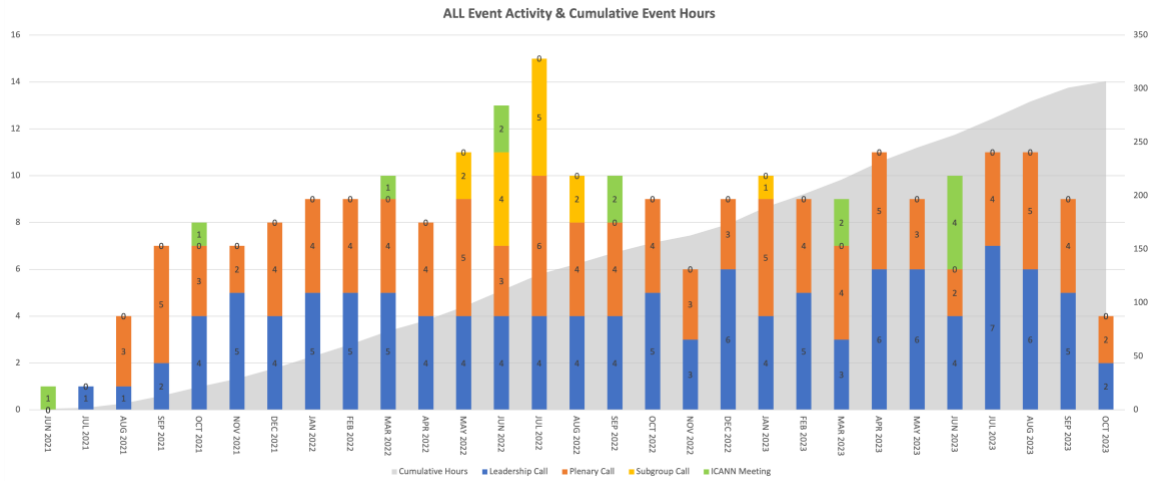

EPDP Team Membership and Attendance:

Members of the EPDP Team, as well as liaisons from the GNSO Council and ICANN Board, are:

Represented Group	SOI	Start Date	Depart Date	Attended %	Role
At-Large Advisory Committee (ALAC)				88.4%	
Satish Babu	SOI	5/25/2021		89.1%	
Abdulkarim Oloyede	SOI	5/25/2021		82.4%	
Hadia Elminiawi	SOI	7/14/2021		93.5%	
Commercial Business Users Constituency (BC)				5.9%	
Mark William Datysgeld	SOI	5/25/2021	5/12/2022	5.9%	
GNSO Council				81.5%	
Donna Austin	SOI	8/10/2021		95.1%	Chair
Farell Folly	SOI	7/27/2021		66.3%	Liaison
Intellectual Property Constituency (IPC)				44.2%	
Brian King	SOI	5/25/2021	11/8/2021	76.9%	
Jeffrey Neuman	SOI	5/25/2021		39.6%	
Internet Service Providers and Connectivity Providers Constituency (ISPCP)				42.7%	
Christian Dawson	SOI	7/12/2021		36.7%	
Nitin Walia	SOI	5/31/2023		84.6%	
Non-Commercial Stakeholder Group (NCSG)				27.6%	
Taiwo Akinremi	SOI	7/15/2021		15.4%	
Emmanuel Elolo Agbenonwossi	SOI	7/13/2022		53.8%	
Grace Githaiga	SOI	7/26/2023		0.0%	
Registrar Stakeholder Group (RrSG)				89.3%	
Michael Bauland	SOI	5/25/2021		85.9%	
Duowei Chen	SOI	9/26/2021	2/13/2022	68.8%	
Zhang Zuan	SOI	2/14/2022		98.6%	
Registry Stakeholder Group (RySG)				81.8%	
Maxim Alzoba	SOI	5/25/2021		80.2%	
Dennis Tan Tanaka	SOI	5/25/2021		93.4%	
Jennifer Chung	SOI	5/25/2021		73.7%	

Represented Group	SOI	Start Date	Depart Date	Attended %	Role
Joseph Chiu-Kit Yee	SOI	7/6/2021	5/2/2023	79.7%	
Governmental Advisory Committee (GAC)				40.1%	
Santhosh Thampy	SOI	5/25/2021		23.1%	
Nigel Hickson	SOI	7/12/2021		57.1%	
ICANN Board				83.2%	
Edmon Chung	SOI	7/27/2021		83.2%	Liaison
Akinori Maemura	SOI	11/18/2021	9/22/2022	80.6%	Liaison
Alan Barrett	SOI	3/16/2023		87.5%	Liaison
Member Totals:				68.4%	

Participants of the EPDP Team are:

Represented Group	SOI	Start Date	Depart Date	Attended %	Role
At-Large Advisory Committee (ALAC)				84.2%	
Justine Chew	SOI	5/25/2021		99.0%	Vice-Chair
TV Gopal	SOI	5/25/2021	3/21/2022	25.0%	
Independent				28.0%	
Abdalmonem Galila	SOI	5/25/2021		5.6%	
Lei Gao	SOI	5/25/2021		1.1%	
Nabil Benamar	SOI	5/25/2021		0.0%	
Shuo (Lisa) Liang	SOI	5/25/2021		92.3%	
Anil Jain	SOI	7/30/2021		71.4%	
Quoc Pham	SOI	8/13/2021		13.6%	
Imran Hossen	SOI	11/4/2021		22.0%	
Wael Nasr	SOI	6/9/2022		0.0%	
Abdulnadir Roba	SOI	8/22/2023		66.7%	
Registry Stakeholder Group (RySG)				49.7%	
Jerry Sen	SOI	5/25/2021		95.6%	
Wei (Wesley) Wang	SOI	7/13/2021		3.3%	
Governmental Advisory Committee (GAC)				67.8%	
Hamza Onoruoiza Salami	SOI	5/25/2021	7/20/2023	70.4%	

Represented Group	SOI	Start Date	Depart Date	Attended %	Role
Amina Ramallan	SOI	7/20/2023		44.4%	
Participant Totals:				41.6%	

As of the publication of this report, there are a total of 11 observers to the EPDP Team.

13 Annex G – Community Input

13.1 Request for Input

According to the GNSO’s PDP Manual, a PDP working group should formally solicit statements from each GNSO Stakeholder Group and Constituency at an early stage of its deliberations. A PDP working group is also encouraged to seek the opinion of other ICANN Supporting Organizations and Advisory Committees who may have expertise, experience, or an interest in the issue.

As a result, the EPDP Team reached out to all ICANN Supporting Organizations (SOs) and Advisory Committees (ACs) as well as all GNSO Stakeholder Groups and Constituencies with requests for input at the start of its deliberations. In response, statements were received from the:

- Registries Stakeholder Group (RySG)
- Security and Stability Advisory Committee (SSAC)
- Country Code Names Supporting Organization (ccNSO) (specifically its ccPDP4 Variant Management Subgroup)

Their full statements can be found here: <https://community.icann.org/x/0gaHCg>

Community input was also sought through Public Comment on the EPDP Team’s Phase 1 Initial report. Input received can be found here: <https://community.icann.org/x/Y5GZDg>

13.2 Review of Input Received

All of the early input statements received were added to the relevant working documents and considered by the EPDP Team as part of its deliberations on each topic.

In addition, IDN subject matter experts from the SSAC met with the EPDP Team during an engagement session in January 2022 to discuss their views on specific charter questions.³⁰⁸ These inputs were recorded in SAC120, which was published in April 2022.³⁰⁹ A second engagement session with SSAC was held in May 2023, which focused on selected preliminary recommendations published in the Phase 1 Initial Report for Public Comment.³¹⁰

The EPDP Team received twelve (12) submissions from the Public Comment on its Phase 1 Initial Report. The EPDP Team reviewed all of the input received, using the Public Comment Review

³⁰⁸ SSAC engagement session in January 2022:

<https://community.icann.org/pages/viewpage.action?pageId=183992713>

³⁰⁹ SAC120: <https://www.icann.org/en/system/files/files/sac-120-en.pdf>

³¹⁰ SSAC engagement session in May 2023: <https://community.icann.org/x/YIZXDg>

Tool developed by policy support staff.³¹¹ The EPDP Team took into account the comments in finalizing its Phase 1 recommendations.

While the Public Comments did not raise any significant concerns or many new issues that the EPDP Team had not previously considered, the EPDP Team sought guidance from the GNSO Council with regard to four submissions about the potential challenge faced by the “.québec” string application.³¹² The GNSO Council agreed with the EPDP Team’s assessment that those comments were outside the scope for the EPDP to address.³¹³

³¹¹ Learn more about the Public Comments received for the Phase 1 Initial Report here:

<https://community.icann.org/x/Y5GZDg>

³¹² The comments in question were submitted by: [Nacho Amadoz on behalf of Amadeu Abril i Abril](#), [Louis Houle](#), [Normand Fortier](#), and [Claude Menard](#)

³¹³ See the GNSO Council Guidance statement on “.québec” related comments here:

<https://mm.icann.org/pipermail/council/attachments/20230906/44f7ad7b/GNSOCouncilGuidanceon.qubec-0001.pdf>

14 Annex H – New gTLD Program Process Flow Diagram

This process flow diagram was created to support the EPDP Team’s deliberation on Charter Question D1b regarding the process by which an existing registry operator could apply for an allocatable variant label of its existing gTLD. It was first presented during the EPDP working session in the ICANN75 Public Meeting.³¹⁴

The process flow assumed that the next application round of the New gTLD Program would have similar application and evaluation elements as the 2012 round. It also anticipated new elements based on the recommendations from the SubPro PDP as well as a subset of recommendations from the EPDP-IDNs.

Note that this diagram was a working product to support understanding of the impact of a subset of EPDP Team’s recommendations that were drafted at the time of the EPDP Team’s deliberation of Charter Question D1b. It was not intended to be authoritative.

There has been no substantive change to the diagram since September 2022, except that the EPDP Team’s recommendation numbers are updated to map to the current numbers in this Final Report, for the ease of reference.

³¹⁴ See the session recording here: <https://community.icann.org/x/GAJpD>

"Pre-Program" Processes:
Processes that happen before the Program starts

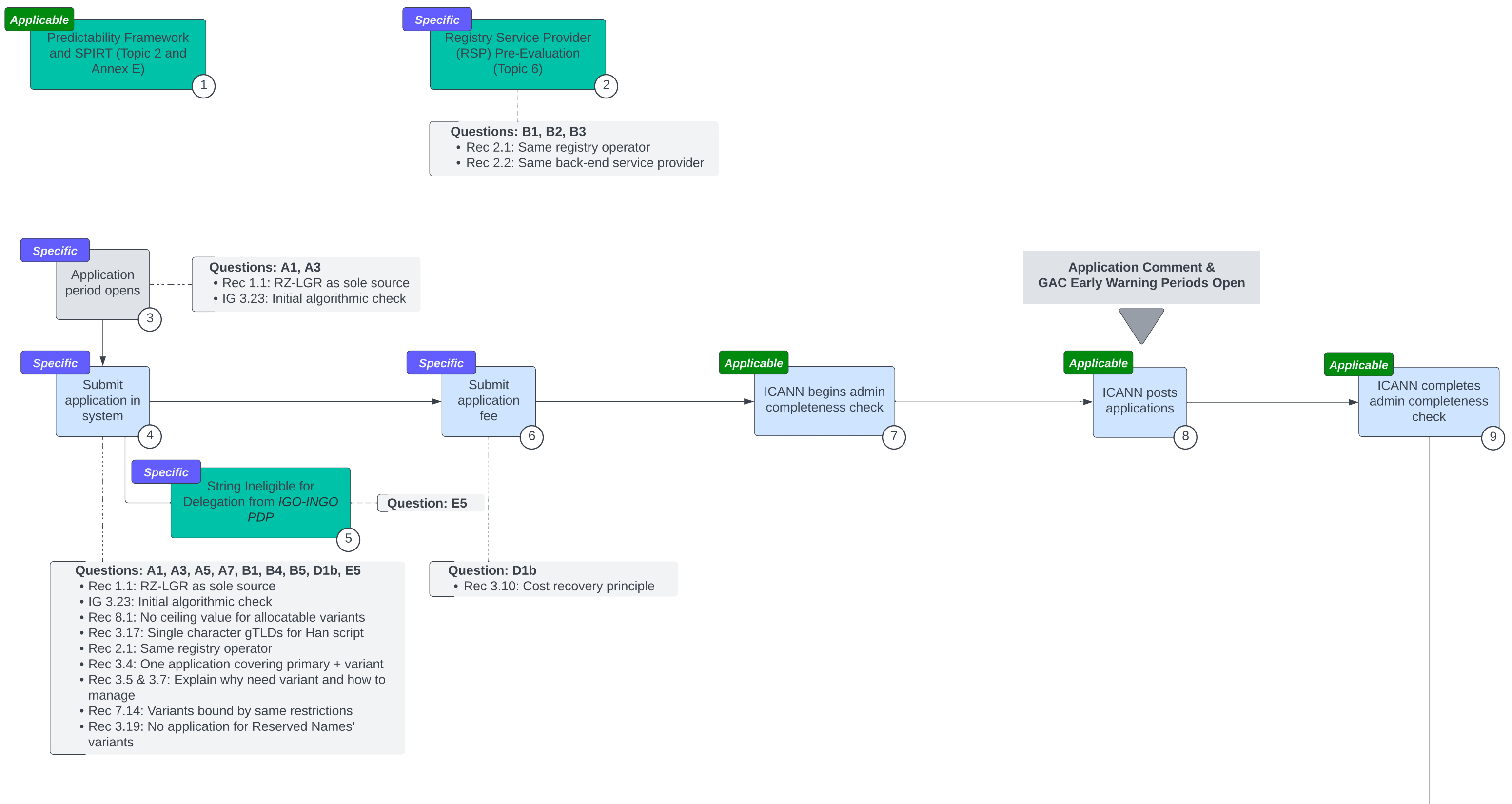

"Persistent" Processes:
Processes that impact multiple stages of the program

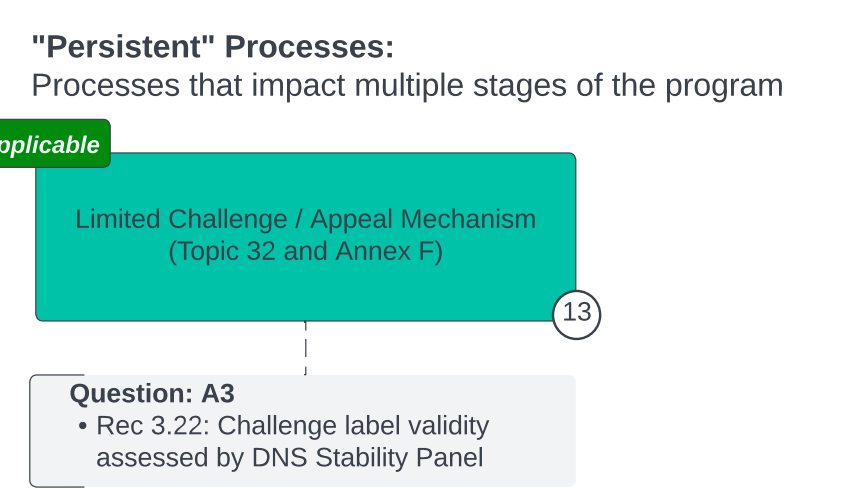
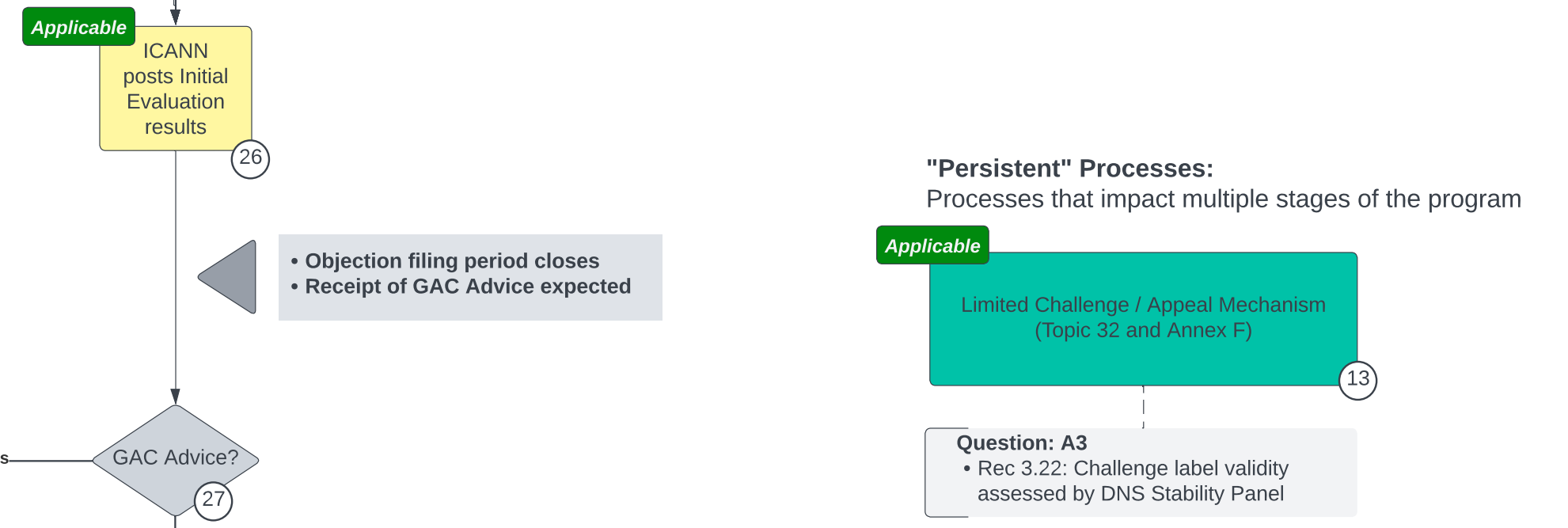
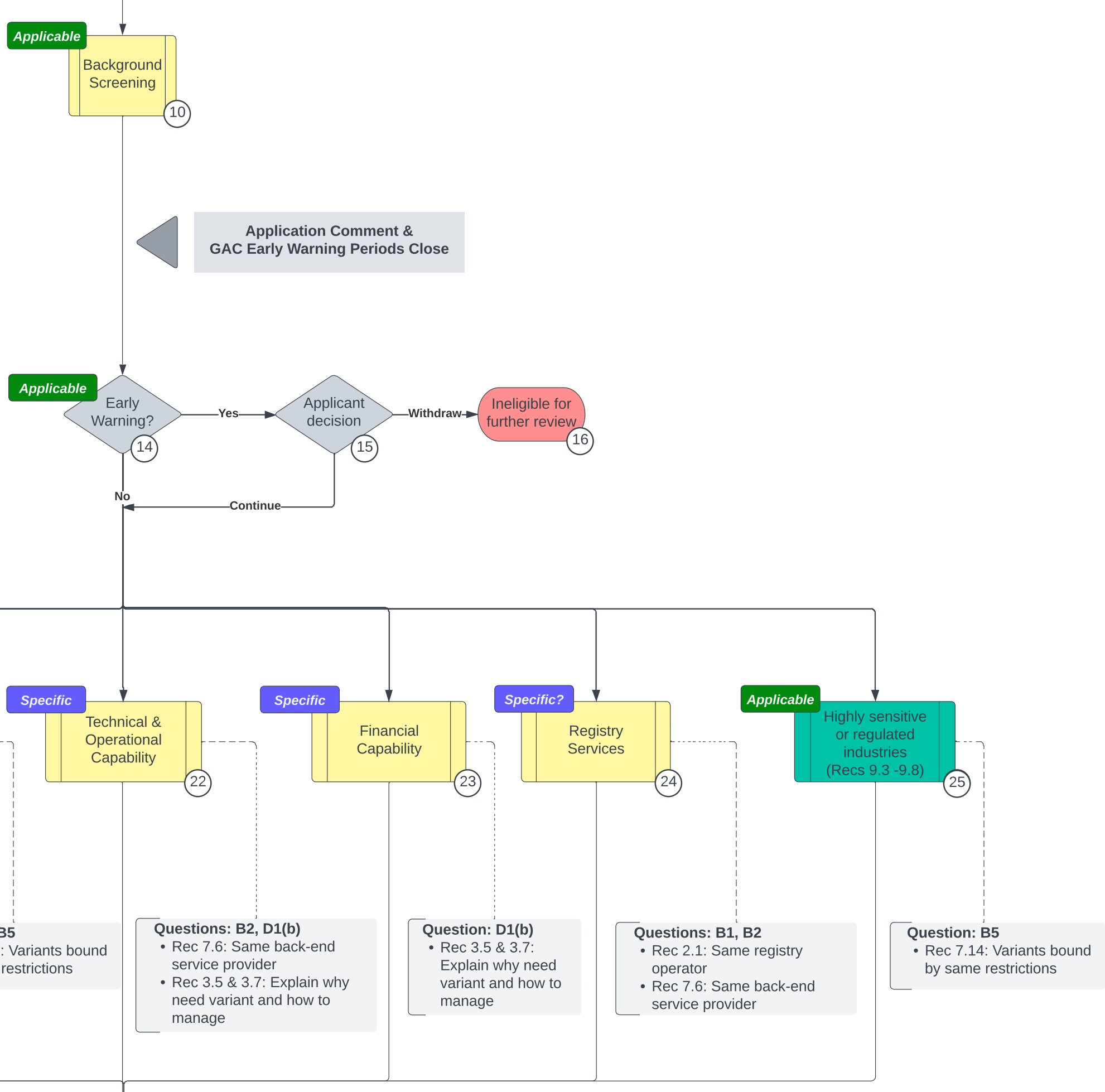
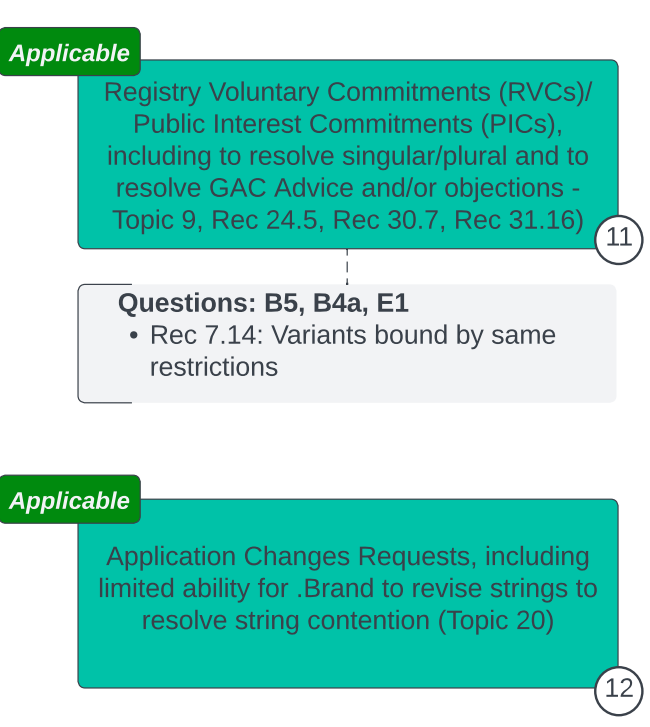

Purpose of this flowchart: With SubPro and this EPDP coming to general agreement on 1) the requirement to rely on the RZ-LGR to determine valid gTLDs and 2) "same-entity" requirements for variant labels, it is important to consider what aspects of the New gTLD Program will be impacted by these principle level recommendations.

Understanding **which** elements will be impacted is important for a number of reasons, including:

- Then, considering **how** program elements will need to be modified to accommodate variant labels, including the new elements proposed by SubPro.
- Better understanding approximate level of effort for evaluating variant labels, which is relevant to a cost-neutral approach for determining fees.
- Better understanding the viability of a standalone round for variants of existing Arabic and Chinese gTLDs.

Assumptions:

- The next round of the New gTLD Program is expected to have relatively similar evaluation process elements, based on SubPro recommendations.
- As such, the above process is based on the 2012 process flow.
- However, with the SubPro recommendations still being evaluated in the ODP and pending Board adoption, along with future implementation, the next round of the program is subject to change.
- As this process flow is based on current expectations for the next round and preliminary outcomes of the EPDP, it is therefore a living document. Relevant EPDP charter questions and preliminary recommendations are referenced in the chart.

Key: Specific

Some elements of the program will require "Specific" consideration and modification of process to accommodate variant labels. For example, when submitting an application that also requests allocatable variant labels, there will presumably be additional application questions/responses and additional fees paid (based on preliminary outcomes). The process will need to be specifically designed to accommodate these changes. Evidently the EPDP Team likely has developed or may develop recommendations and/or implementation guidance to cater to the "specific" changes.

Applicable

However, some elements of the program will be largely unimpacted as a result of variant labels, but variant labels still need go through those stages or steps just like a regular gTLD application. For instance, in performing a completeness check, the variant label related questions will also be validated, but there is no **specific** change to the process envisioned. The EPDP Team likely does not need to develop recommendations or implementation guidance for those elements.

